

| ASSESSERINGSKRITERIA | |
|----------------------|-----------------------------|
| 1 | PLASING + HULPAANSIG 2 |
| 2 | VOOR- + MIDDELSTE VLAKKE 20 |
| 3 | GESNYDE VLAK + ARSERING 12 |
| 4 | SIRKEL + SL 6 |
| TOTAAL 40 | |

VRAESTEL 2 VRAAG 3
 GRAAD 12
 NOVEMBER 2023
 NASIENRIGLYNE

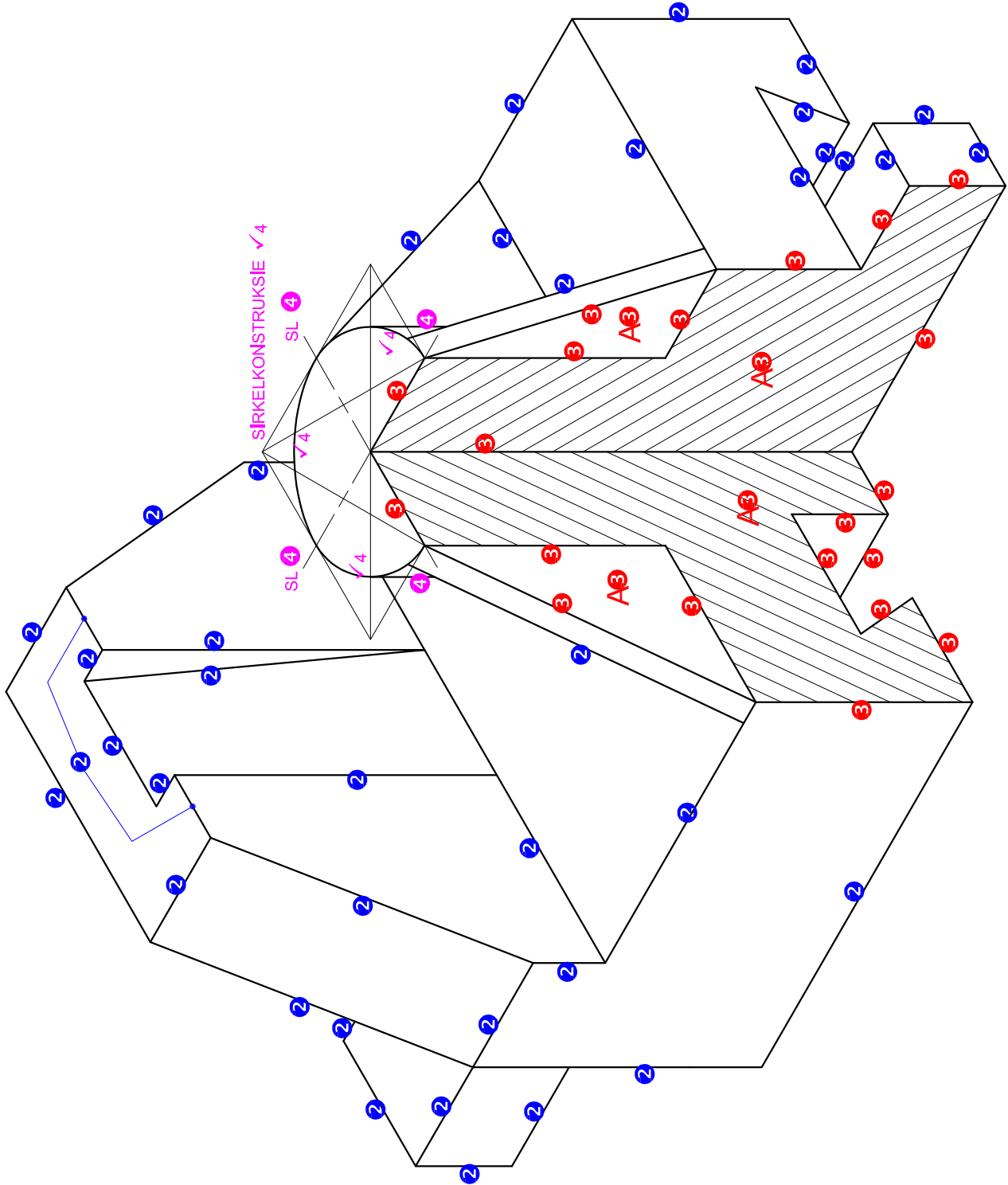

✓1 PLASING/ORSENTERING

BOOGKONSTRUKSIE ✓ 4

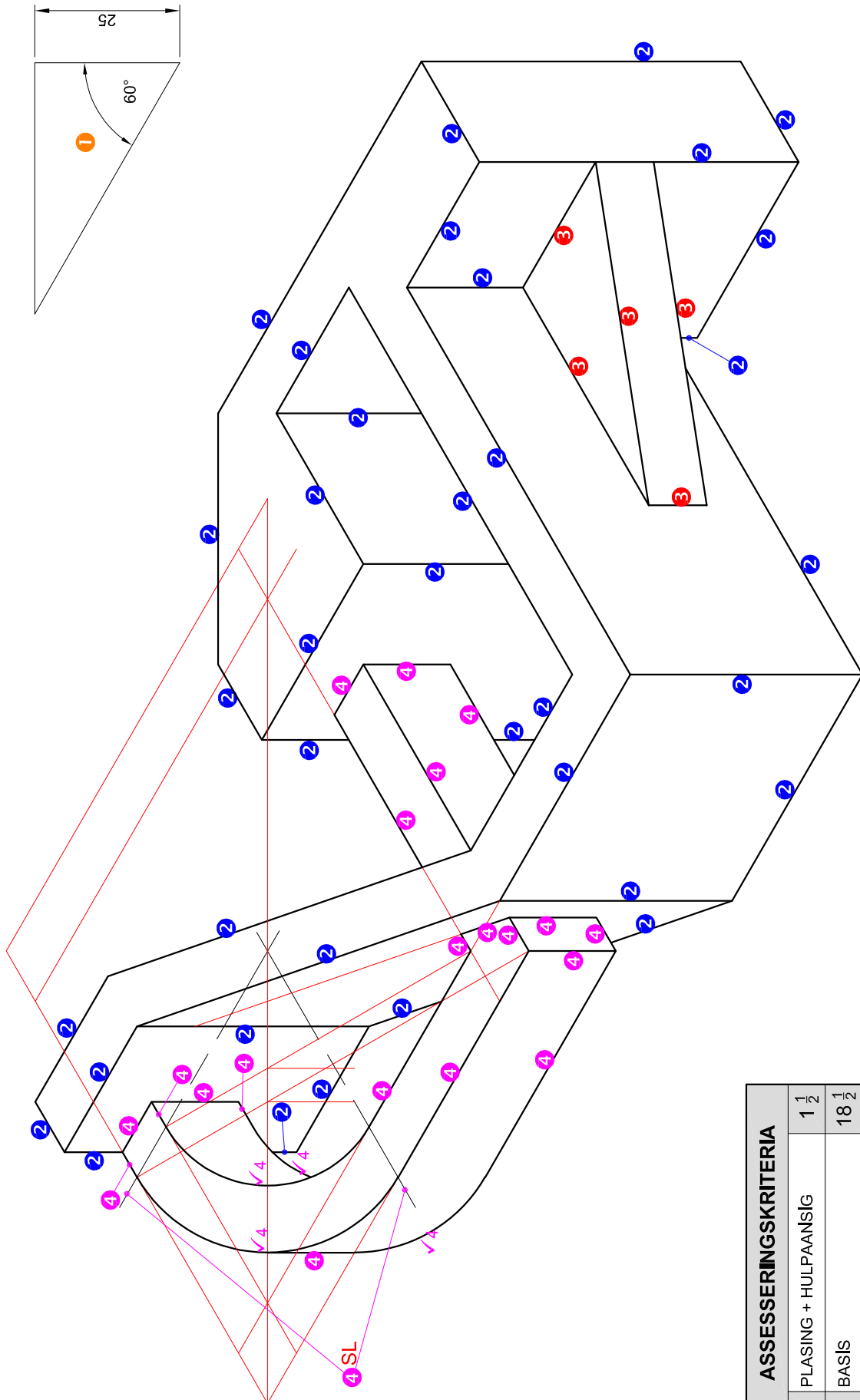

P ✓ 1 PLASING / ORIËNTERING

VRAESTEL 2 VRAAG 3
 GRAAD 12
 2023
 NASIENRIGLYNE

| ASSESSERINGSKRITERIA | | |
|----------------------|--------------------------------|-----------|
| 1 | PLASING + HULPAANSIG | 1 ½ |
| 2 | BASIS | 18 ½ |
| 3 | WEB | 2 ½ |
| 4 | SIRKEL + SENTERLYNE + SPANSTUK | 15 ½ |
| TOTAAL | | 38 |

ASSESSERINGSKRITERIA

| | | |
|---------------|------------------------|-----------|
| 1 | PLASING + HULPAANSIG | 2 |
| 2 | ROMP | 20 |
| 3 | HANDVATSEL | 9 1/2 |
| 4 | SIRKELS + KONSTR. + SL | 8 1/2 |
| TOTAAL | | 40 |

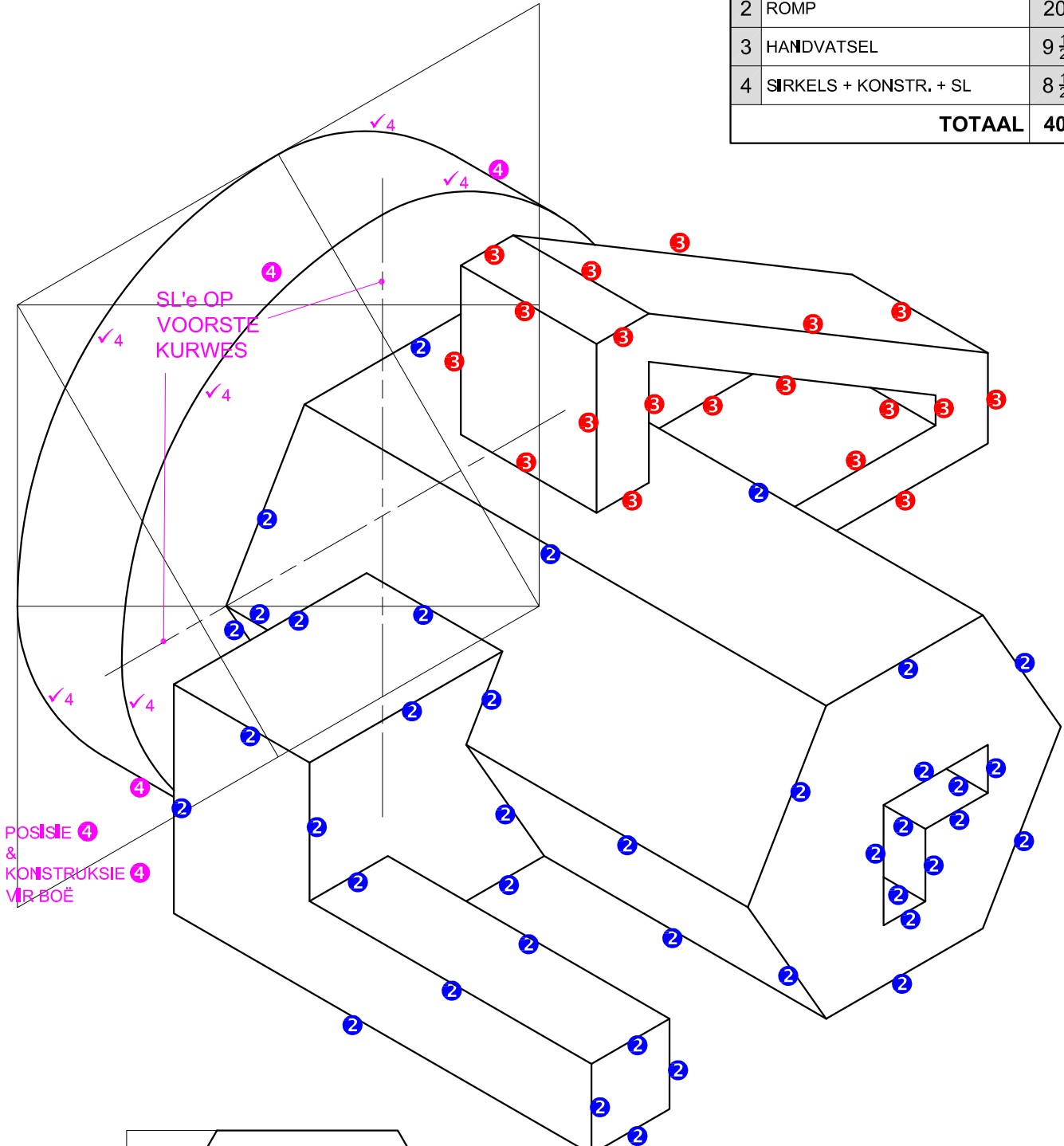

POSISIE 4
&
KONSTRUKSIE 4
VIR BOË

SL'e OP
VOORSTE
KURWES

A
PLASING / ORIENTERING ✓1

VRAESTEL 1 VRAAG 3
GRAAD 12
NOVEMBER 2022
NASIENRIGLYNE

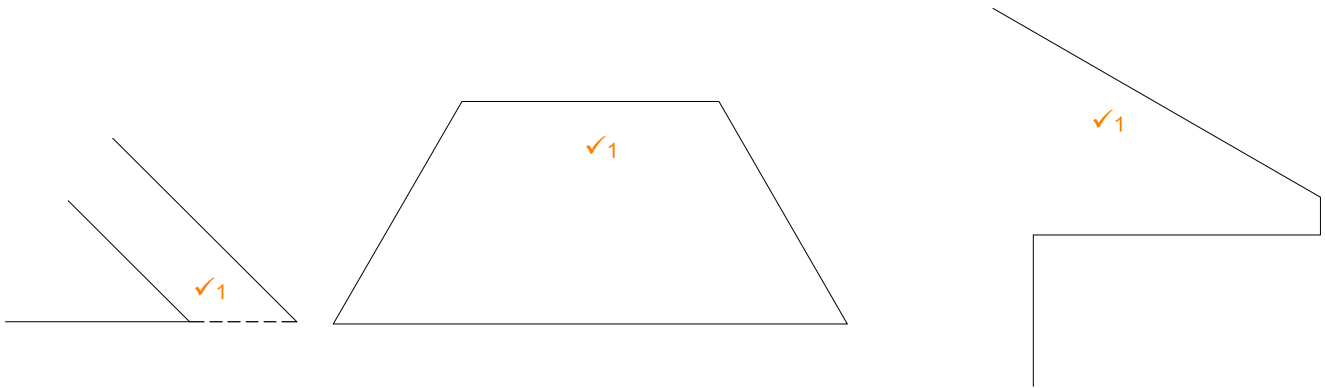

| ASSESSERINGSKRITERIA | | |
|----------------------|-------------------------------|-----------|
| 1 | PLASING + HULPAANSIGTE | 4 |
| 2 | LINKERGEDEELTE | 17 |
| 3 | MIDDELGEDEELTE | 7 ½ |
| 4 | REGTERGEDEELTE | 5 |
| 5 | SIRKEL + SENTERLYNE + KONSTR' | 5 ½ |
| TOTAAL | | 39 |

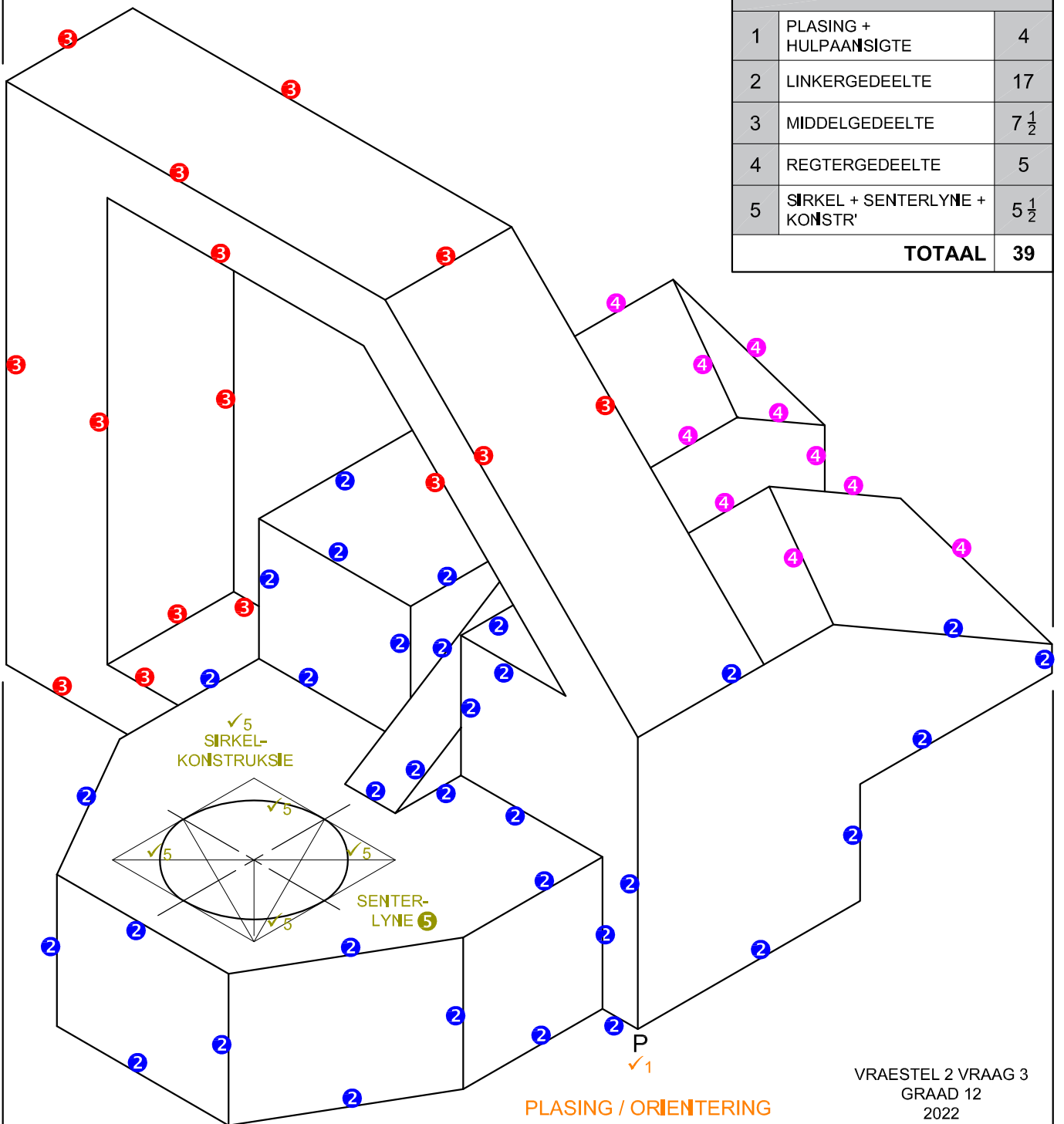

VRAESTEL 2 VRAAG 3
 GRAAD 12
 2022
 NASIENRIGLYNE

HULPAANSIG ✓1

SIRKEL KONSTR. ✓4

A

✓1 KORREKTE PLASING / ORIENTERING

| ASSESSERINGSKRITERIA | |
|----------------------|--------------------------------|
| 1 | PLASING + HULPAANSIG 2 |
| 2 | VOOR- + MIDDELOPPERVLAKKE 16 ½ |
| 3 | SKUINSOPPERVLAKKE 11 |
| 4 | SIRKEL + SESHOEK 10 ½ |
| TOTAAL 40 | |

VRAESTEL 1 VRAAG 3
 GRAAD 12
 NOVEMBER 2021
 NASIENRIGLYNE

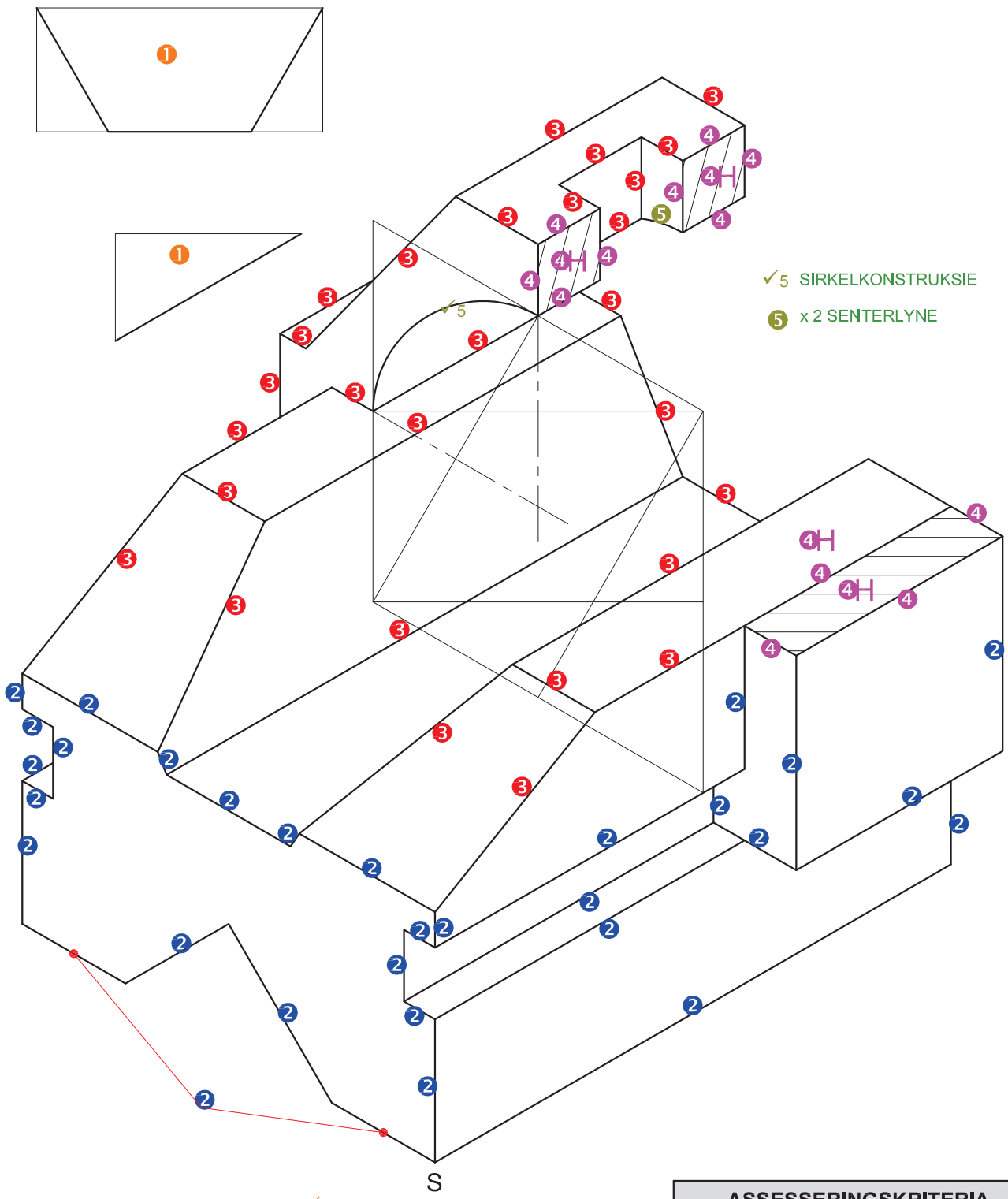

✓ 5 SIRKELKONSTRUKSIE

5 x 2 SENTERLYNE

✓ 1 KORREKTE PLASING

VRAESTEL 2 VRAAG 3
 GRAAD 12
 2021
 NASIENRIGLYNE

| ASSESSERINGSKRITERIA | | |
|----------------------|--|-----------|
| 1 | HULPAANSIG + PLASING | 2 |
| 2 | ONDERSTE GEDEELTE | 15 |
| 3 | BOONSTE GEDEELTE | 14 |
| 4 | SNIT | 8 |
| 5 | ISO-SIRKELS + SIRKELKONSTR' + SENTERLYNE | 3 |
| TOTAAL | | 42 |

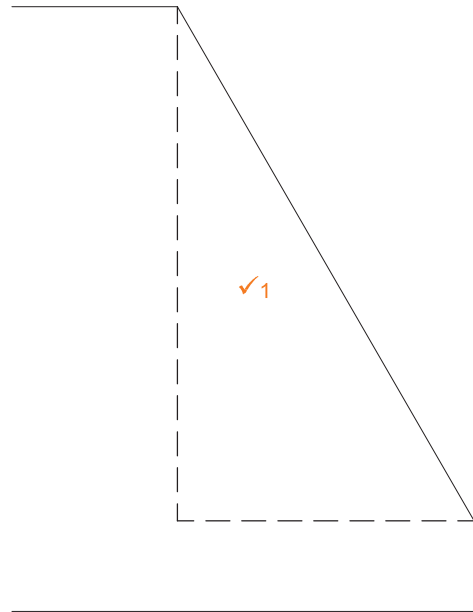
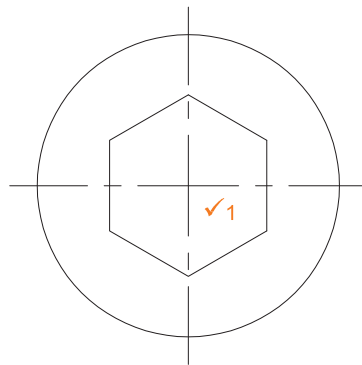

✓ 4 SIRKEL-KONSTRUKSIE

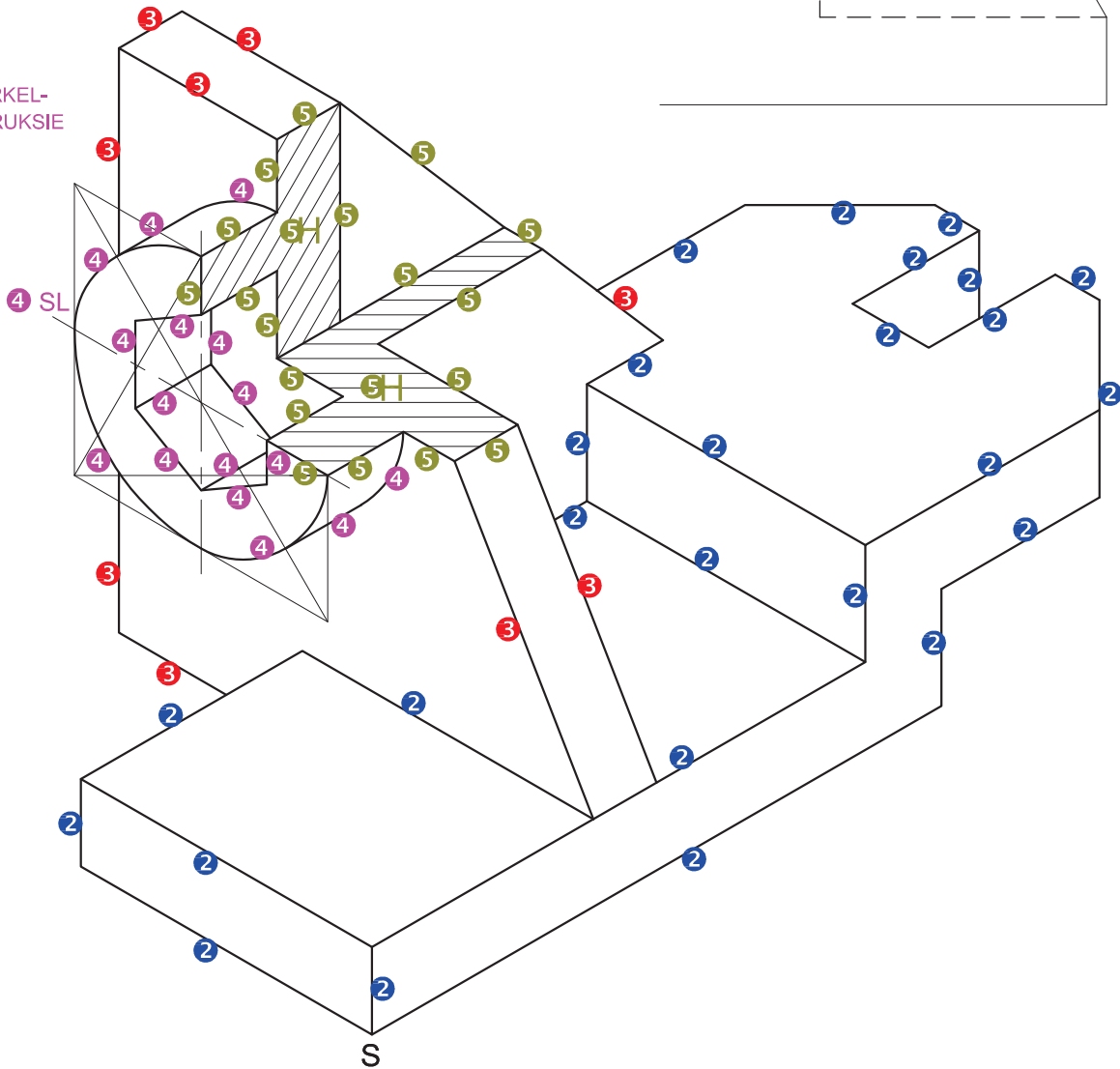

✓ 1 PLASING

VRAESTEL 2 VRAAG 3
 GRAAD 12
 SS/NSS 2020
 NASIENRIGLYNE

| ASSESSERINGSKRITERIA | | |
|----------------------|----------------------|-----------|
| 1 | PLASING + HULPAANSIG | 3 |
| 2 | BASIS | 13 |
| 3 | REGOP GEDEELTE | 4½ |
| 4 | SIRKEL + SESHOEK | 9½ |
| 5 | SNIT | 10 |
| TOTAAL | | 40 |

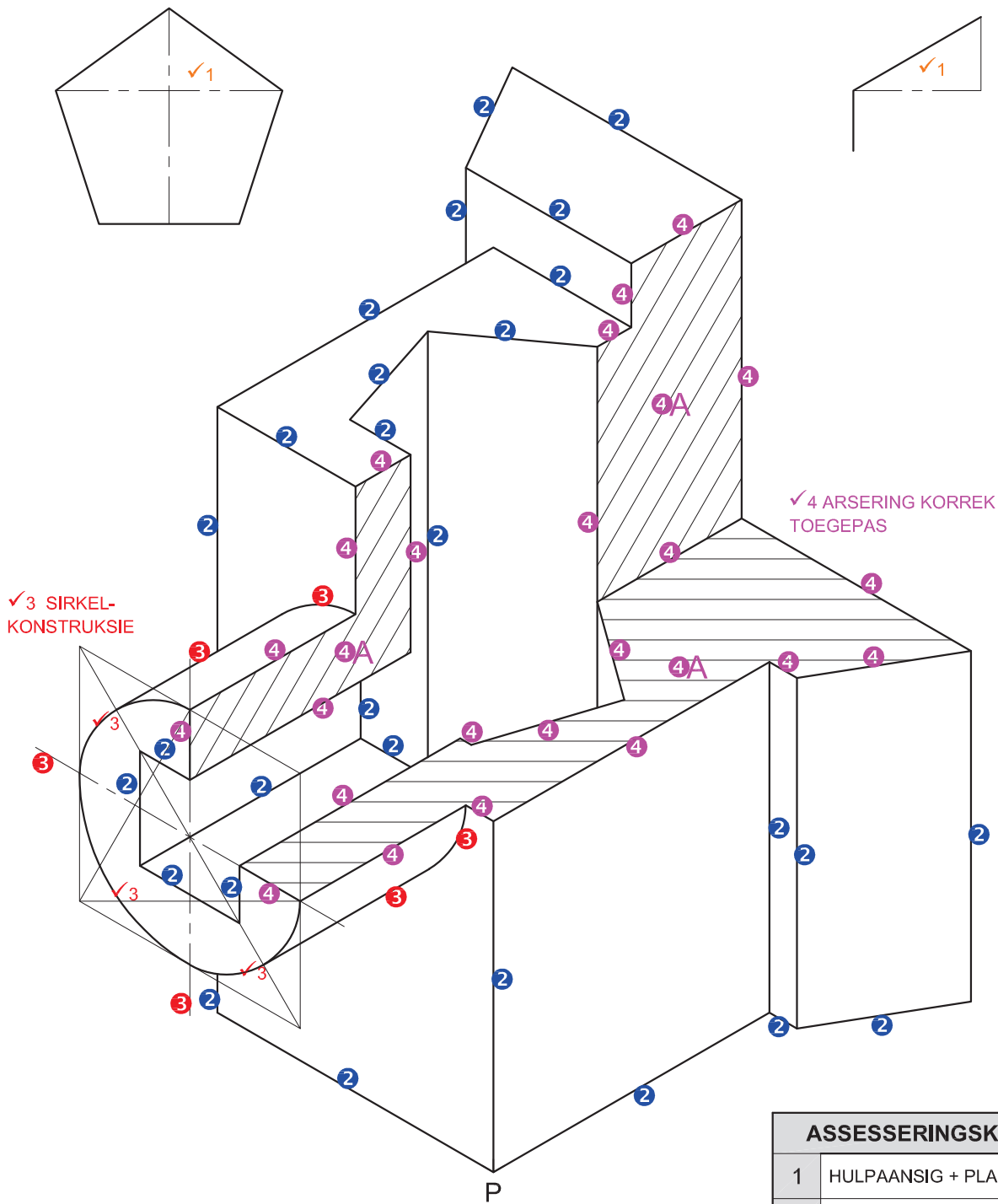

✓3 SIRKEL-KONSTRUKSIE

✓4 ARSERING KORREK TOEGEPAS

✓1 KORREKTE PLASING

| ASSESSERINGSKRITERIA | | |
|----------------------|--------------------------------------|-----------|
| 1 | HULPAANSIG + PLASING | 3 |
| 2 | ISOMETRIESE- + NIE-ISO' LYNE | 14 |
| 3 | ISOMETRIESE SIRKELS + SIRKEL KONSTR' | 7 |
| 4 | GESNYDE VLAKKE + ARSERING | 14 |
| TOTAAL | | 38 |

VRAESTEL 2 VRAAG 3
 GRAAD 12
 SS/NSS 2019
 NASIENRIGLYNE

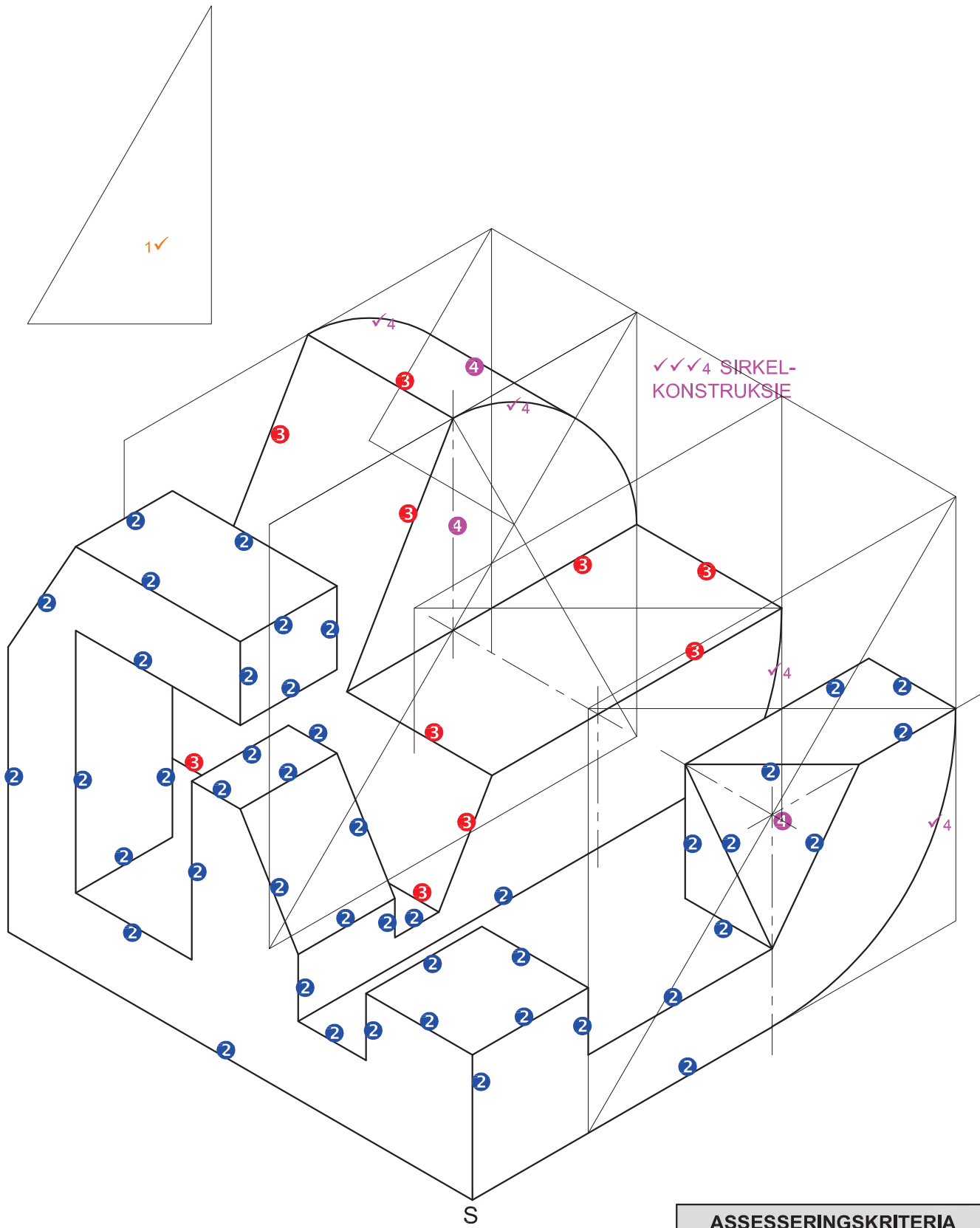

✓1 KORREKTE PLASING

| ASSESSERINGSKRITERIA | | |
|----------------------|----------------------------------|-----------|
| 1 | PLASING + HULPAANSIG | 2 |
| 2 | VOORSTE GEDEELTE | 22½ |
| 3 | AGTERSTE GEDEELTE | 5 |
| 4 | SIRKEL + SIRKEL-KONSTRUKSIE + SL | 8½ |
| TOTAAL | | 38 |

VRAESTEL 2 VRAAG 3
 GRAAD 12
 NOVEMBER 2018
 NASIENRIGLYNE

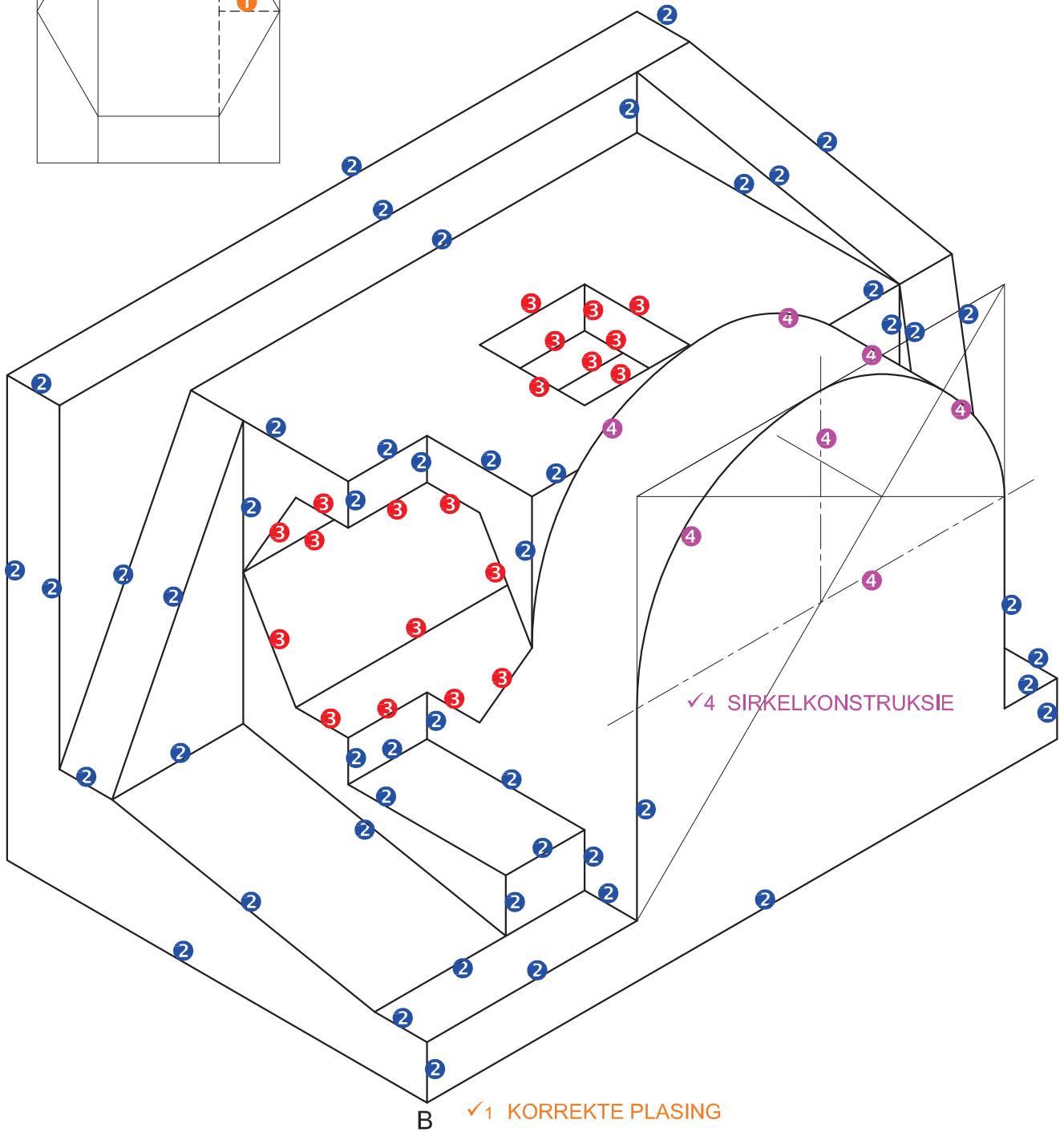
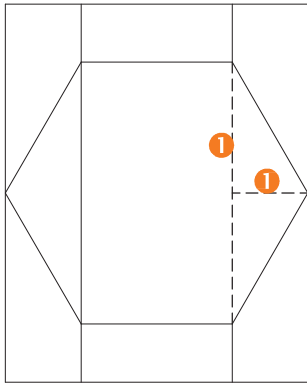

VRAESTEL 2 VRAAG 3
 GRAAD 12
 SSE 2018
 NASIENRIGLYNE

| ASSESSMENT CRITERIA | | |
|---------------------|------------------------------------|------------------|
| 1 | PLASING + HULPAANSIG | 2 |
| 2 | ISOMETRIESE + NIE-ISOMETRIESE LYNE | 24 $\frac{1}{2}$ |
| 3 | SESHOEK + VIERKANT | 10 |
| 4 | SIRKEL + SIRKEL-KONSTRUKSIE + SL | 4 $\frac{1}{2}$ |
| TOTAAL | | 41 |

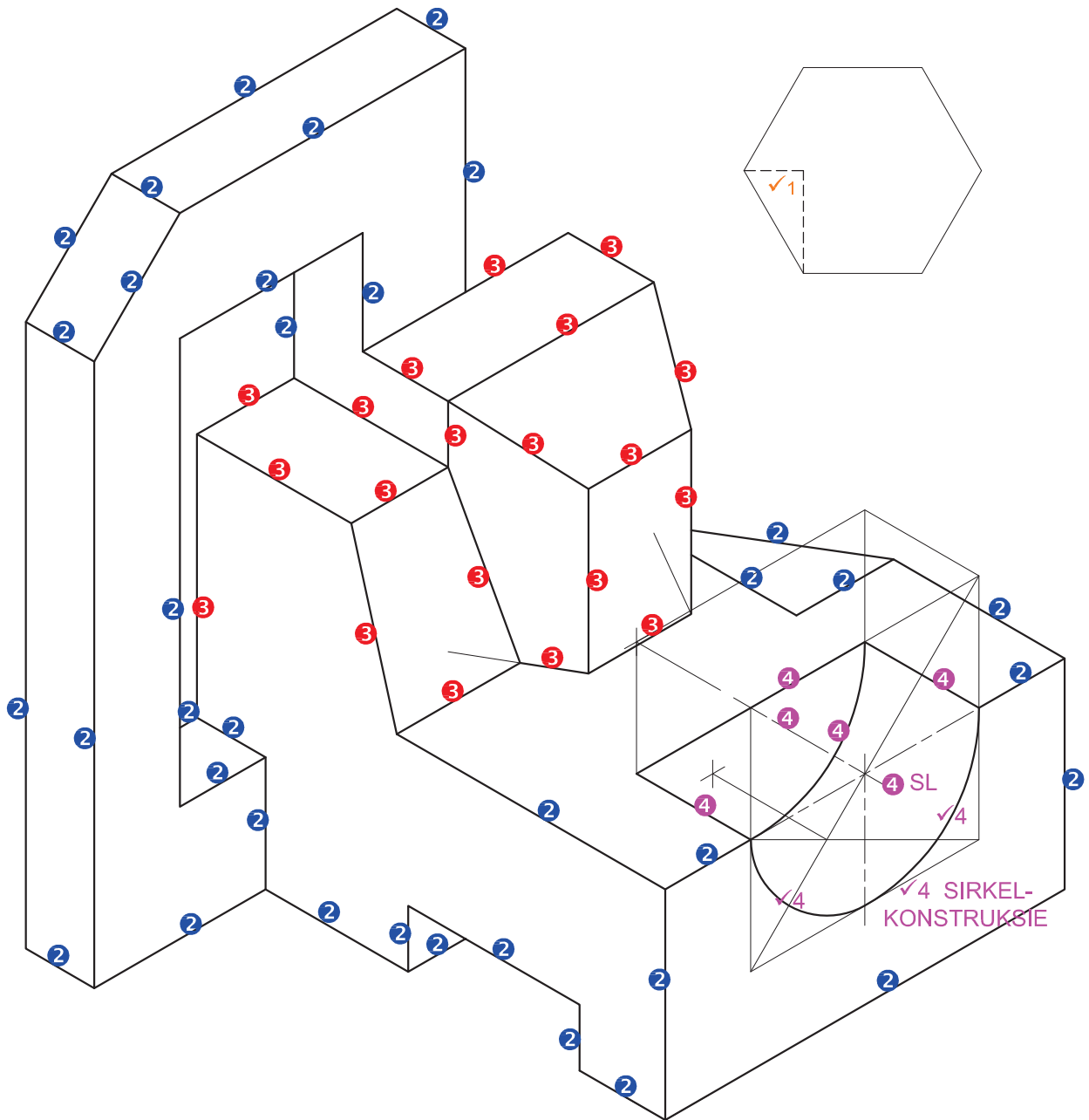

B ✓1 KORREKTE PLASING

| ASSESSERINGSKRITERIA | | |
|----------------------|----------------------------------|-----------|
| 1 | PLASING + HULPAANSIG | 2 |
| 2 | VOOR + AGTER | 18 |
| 3 | MIDDELGEDEELTE | 10 |
| 4 | SIRKEL + SIRKEL-KONSTRUKSIE + SL | 6 |
| TOTAAL | | 36 |

VRAESTEL 2 VRAAG 3
 GRAAD 12
 November 2017
 NASIENRIGLYNE

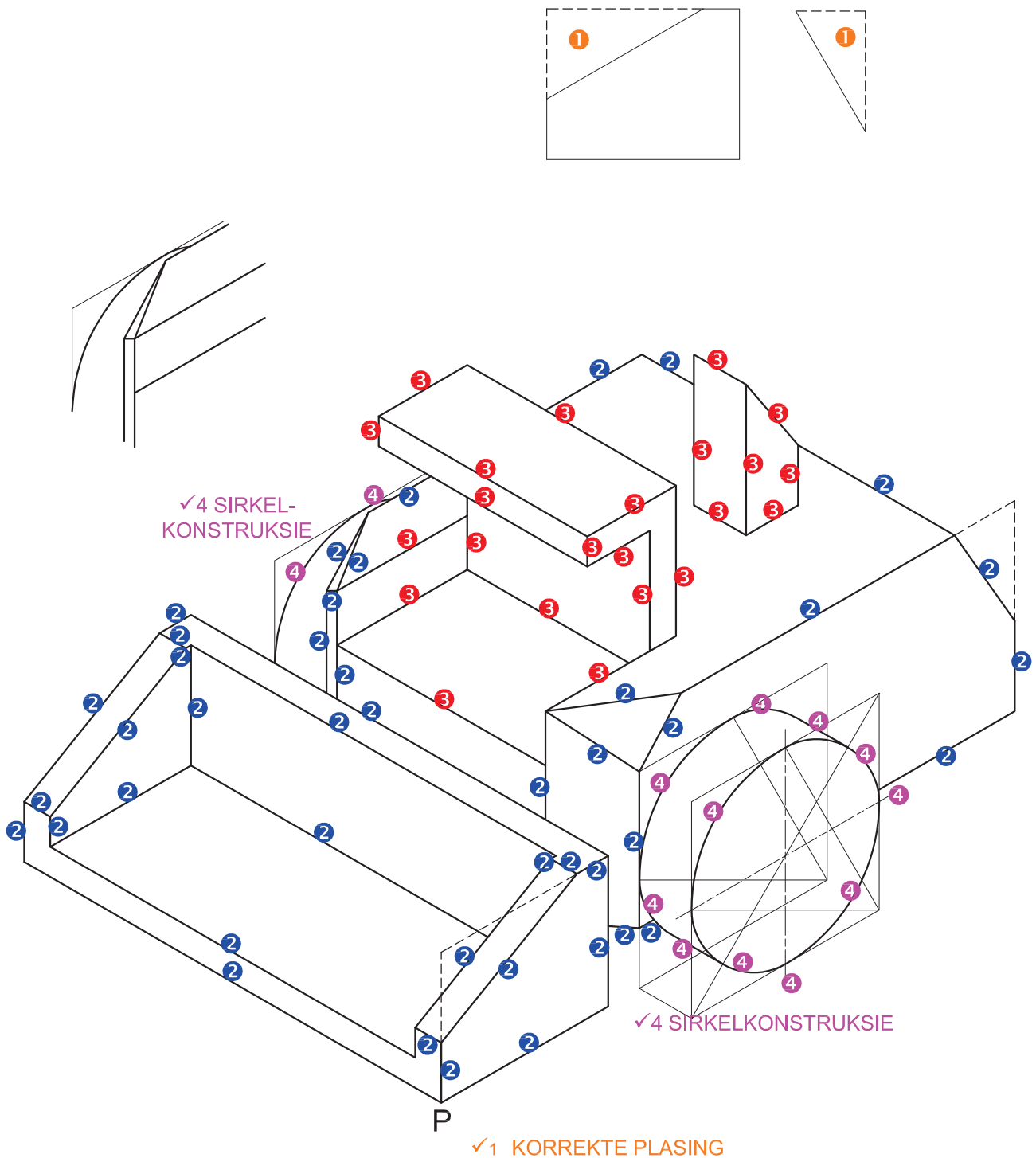

VRAESTEL 2 VRAAG 3
 GRAAD 12
 SSE 2017
 NASIENRIGLYNE

| ASSESSERINGSKRITERIA | | |
|----------------------|----------------------------------|------------------|
| 1 | PLASING + HULPAANSIG | 2 |
| 2 | SKOP + ROMP | 22 |
| 3 | KAJUIT + UITLAAT | 11 $\frac{1}{2}$ |
| 4 | SIRKEL + SIRKEL-KONSTRUKSIE + SL | 8 $\frac{1}{2}$ |
| TOTAAL | | 44 |

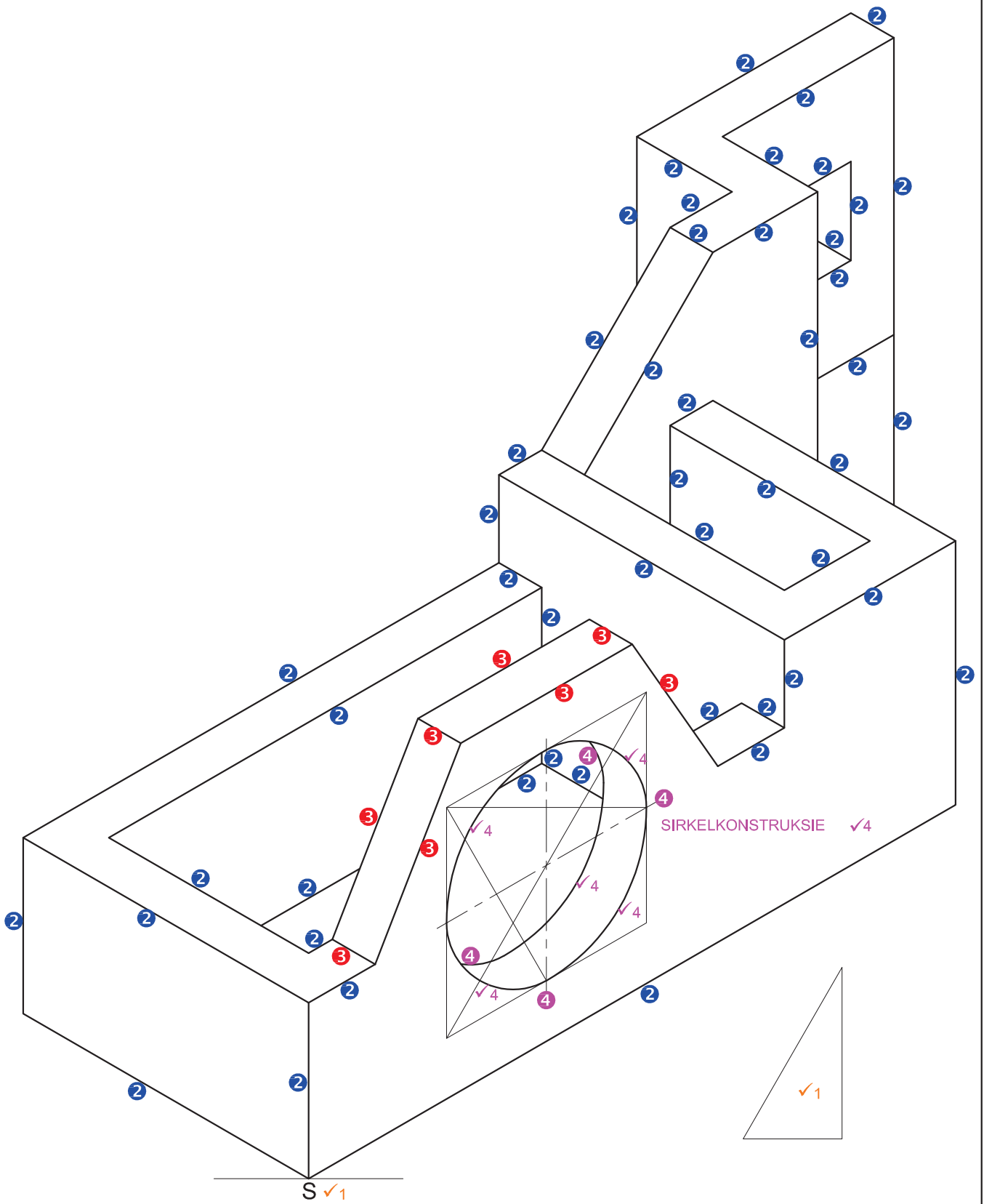

| ASSESSERINGSKRITERIA | | |
|----------------------|------------------------------|-----------|
| 1 | HULPAANSIG + PLASING | 2 |
| 2 | VOORSTE + AGTERSTE GEDEELTES | 25 |
| 3 | SESHOEK | 4 |
| 4 | SIRKEL + SL | 8 |
| TOTAAL | | 39 |

VRAESTEL 2 VRAAG 3
 GRAAD 12
 Feb.-Mrt. 2017
 MEMORANDUM

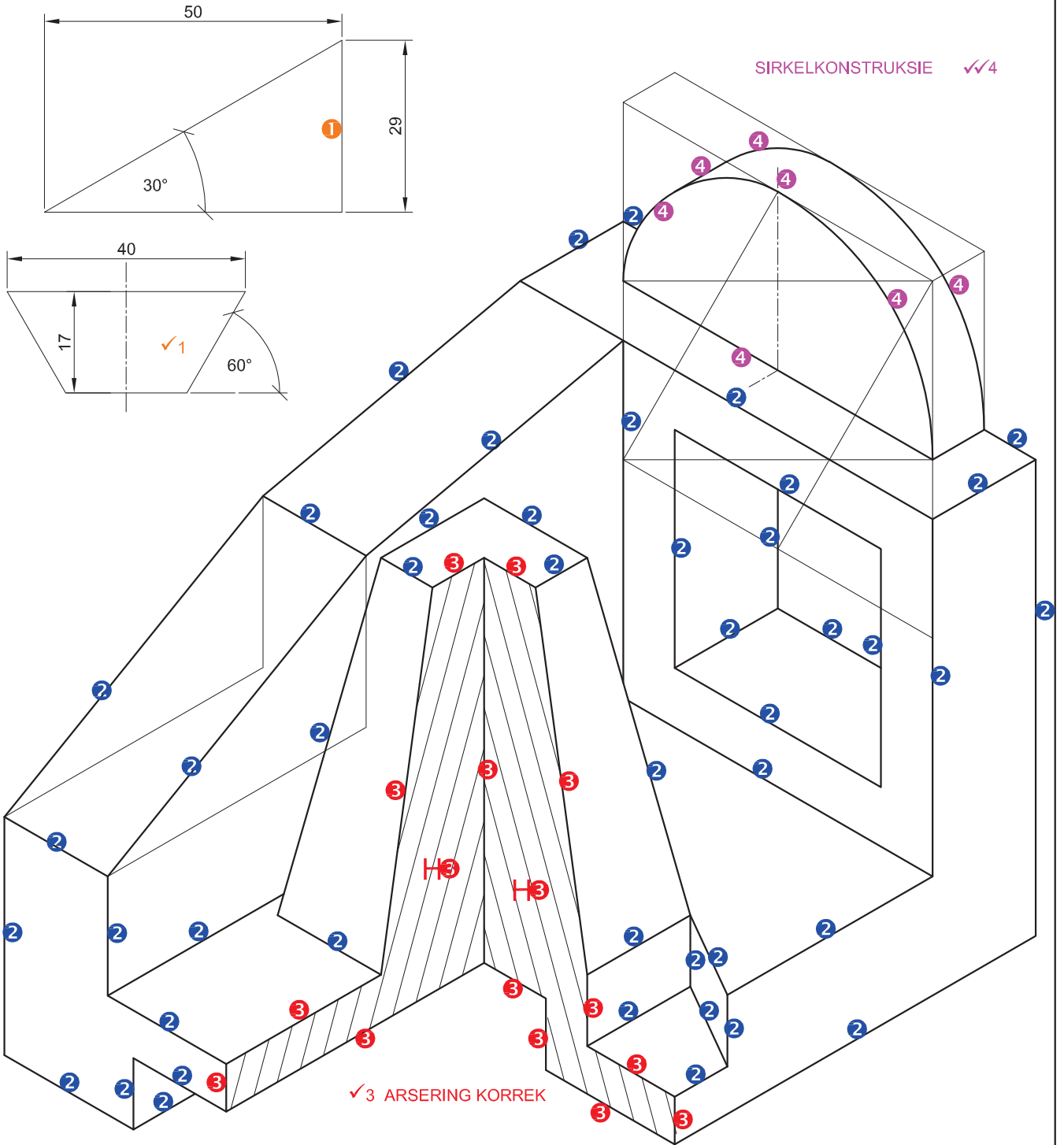

SIRKELKONSTRUKSIE ✓✓4

✓3 ARSERING KORREK

✓1 PLASING OP S

| ASSESSERINGSKRITERIA | | |
|----------------------|-------------------------------------|-----------|
| 1 | HULPAANSIG + PLASING | 2 ½ |
| 2 | ISOMETRIESE + NIE-ISOMETRIESE LYNE | 23 |
| 3 | GESNYDE VLAKKE | 9 |
| 4 | ISOMETRIESE SIRKELS + SIRKELKONSTR' | 5 ½ |
| TOTAAL | | 40 |

VRAESTEL 2 VRAAG 3
 GRAAD 12
 November 2016
 MEMORANDUM

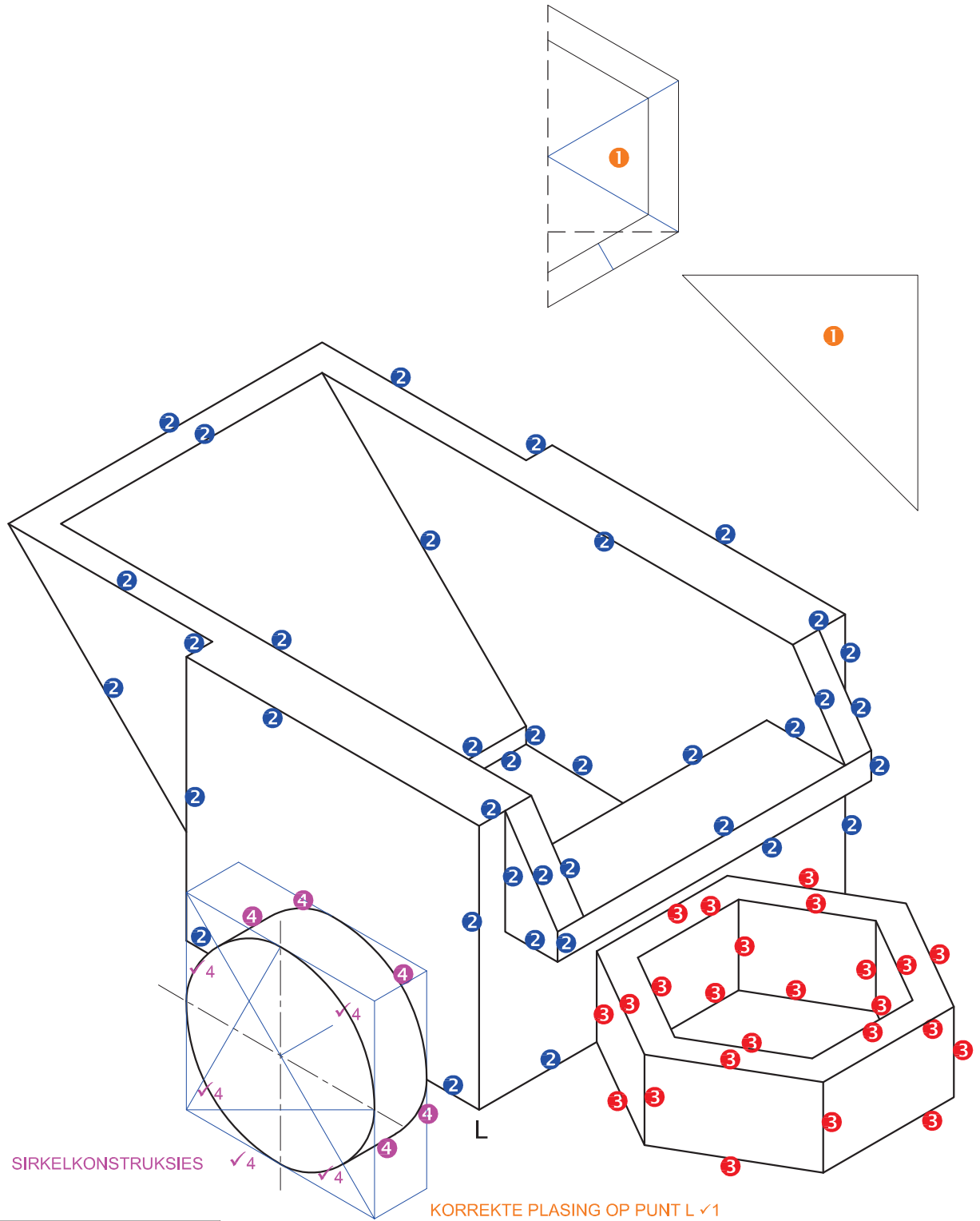

| ASSESSERINGSKRITERIA | | |
|----------------------|-------------------------------------|------|
| 1 | HULPAANSIGTE + PLASING | 2 |
| 2 | ISOMETRIESE + NIE-ISOMETRIESE LYNE | 18 ½ |
| 3 | SESKANT | 12 |
| 4 | SIRKELS + KONSTRUKSIES + SENTERLYNE | 7 ½ |
| PENALISERING (-) | | |
| TOTAAL | 40 | |

VRAESTEL 2 VRAAG 3
 GRAAD 12
 DBE/Feb.-Mrt. 2016
 MEMORANDUM

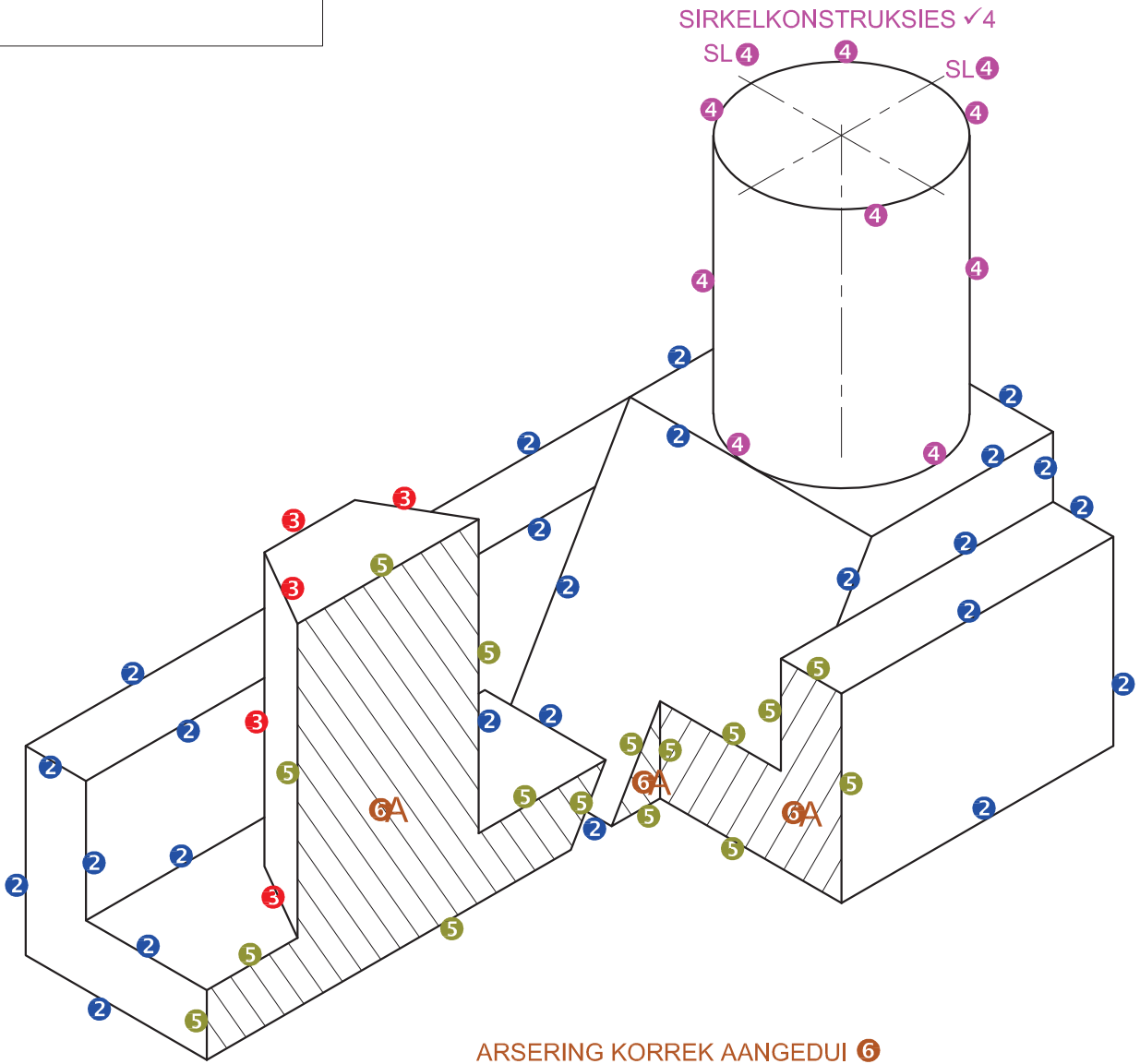
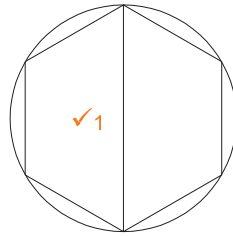
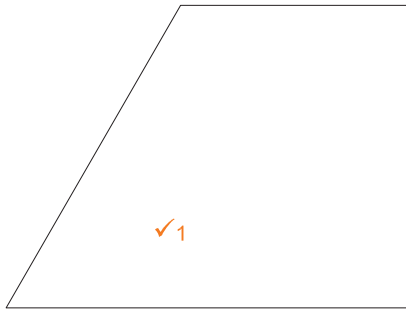

ARSERING KORREK AANGEDUI 6

| ASSESSERINGSKRITERIA | | |
|----------------------|-----------------------------|-----------|
| 1 | HULPAANSIG + PLASING | 3 |
| 2 | ISOMETRIES + NIE-ISOMETRIES | 12 ½ |
| 3 | SESHOEK | 2 ½ |
| 4 | SIRKELS + KONSTRUKSIES + SL | 6 |
| 5 | SNIT | 8 |
| 6 | ARSERING | 2 |
| PENALISERING (-) | | |
| TOTAAL | | 34 |



P KORREKTE PLASING OP PUNT P ✓1

VRAESTEL 2 VRAAG 3
 GRAAD 12
 November 2015
 MEMORANDUM



SIRKELKONSTRUKSIE ✓3✓3

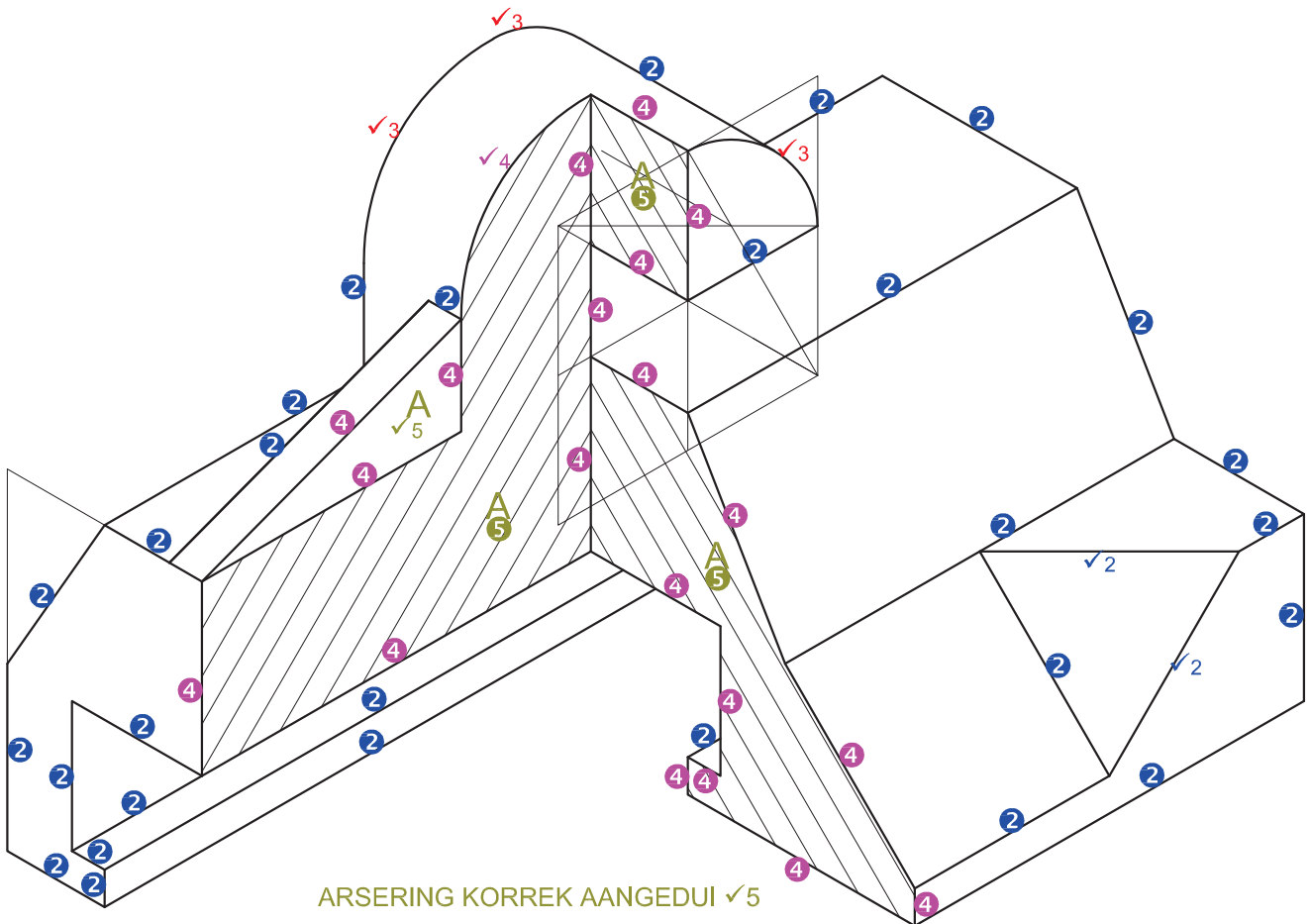

ARSERING KORREK AANGEDUI ✓5

KORREKTE PLASING OP PUNT P ✓1

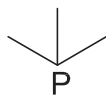

| ASSESSERINGSKRITERIA | | |
|----------------------|--|-----------|
| 1 | HULPAANSIG + PLASING | 3 |
| 2 | ISOMETRIESE + NIE-ISOMETRIESE LYNE | 10½ |
| 3 | ISOMETRIESE SIRKELS + SIRKELKONSTRUKSIES | 5 |
| 4 | GESNYDE VLAKKE | 11 |
| 5 | ARSERING | 3½ |
| PENALISERING (-) | | |
| TOTAAL | | 39 |

VRAESTEL 2 VRAAG 3
 GRAAD 12
 Feb.-Mrt. 2015
 MEMORANDUM

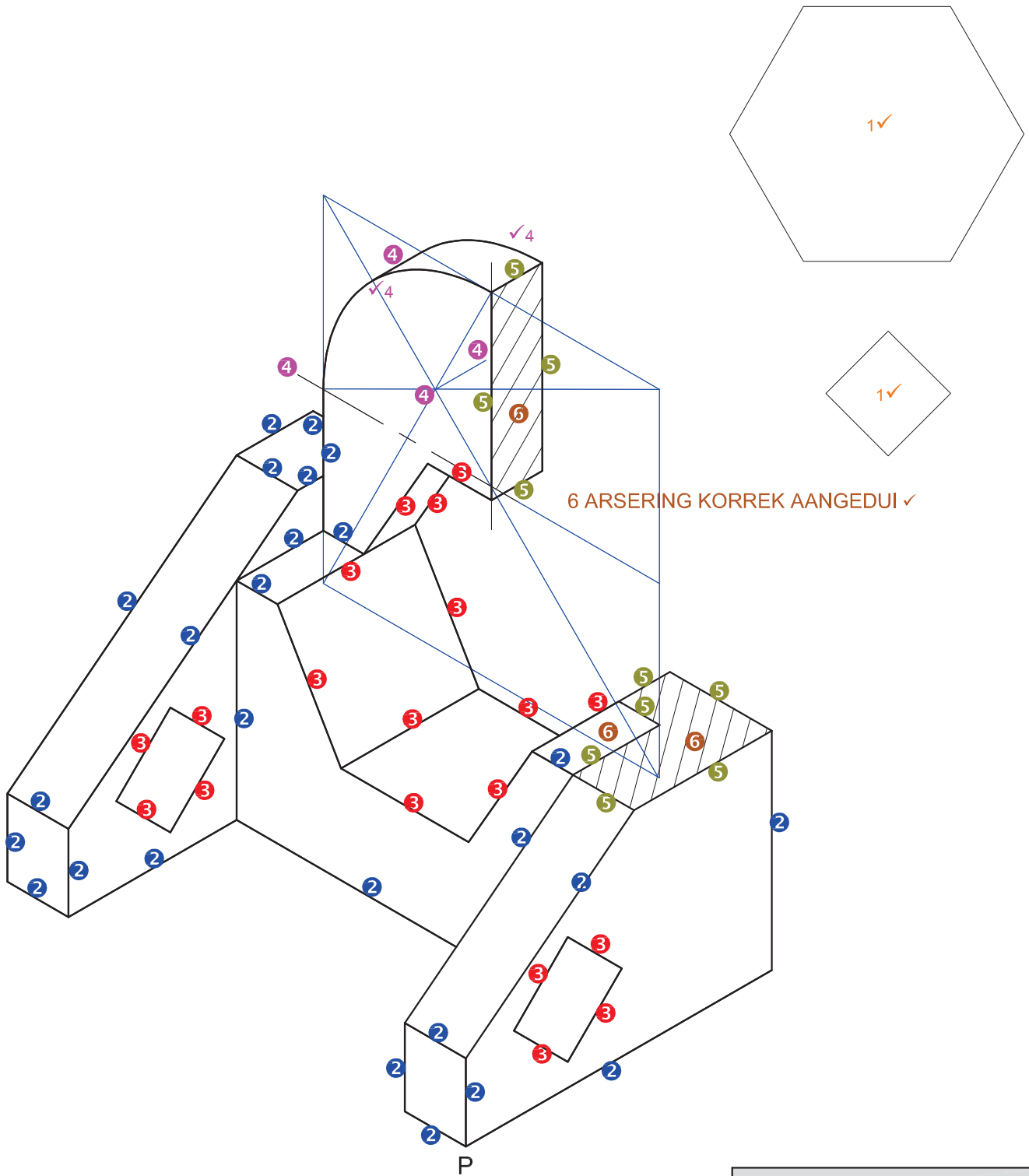

KORREKTE PLASING OP PUNT P ✓

VRAESTEL 2 VRAAG 3
 GRAAD 12
 November 2014
 MEMORANDUM

| ASSESSERINGSKRITERIA | | |
|----------------------|----------------------|-----------|
| 1 | HULPAANSIG + PLASING | 3 |
| 2 | ISOMETRIES + NIE-ISO | 13 |
| 3 | SESHOEK + VIERKANTE | 9½ |
| 4 | SIRKELS + KONSTR. | 4 |
| 5 | SNIT | 5 |
| 6 | ARSERING | 2½ |
| PENALISERING (-) | | |
| TOTAAL | | 37 |

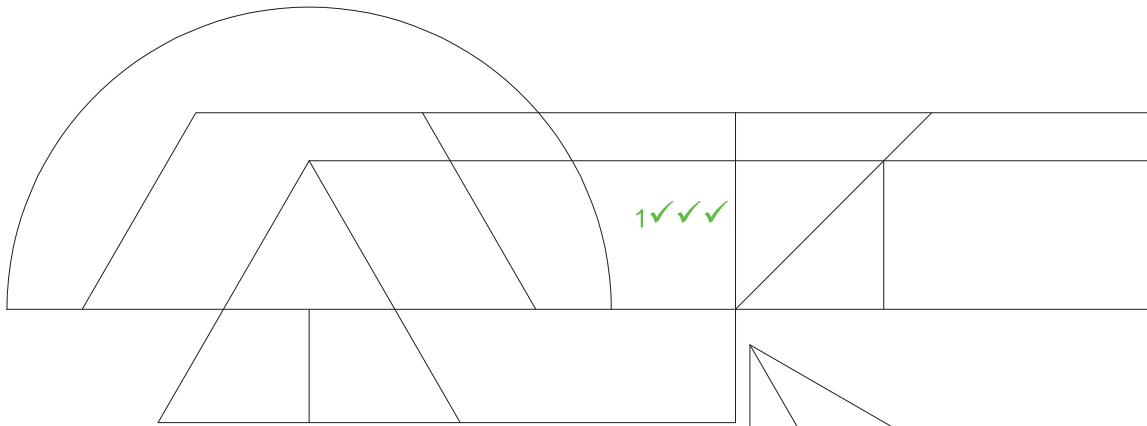

SIRKELKONSTRUKSIE 4✓✓

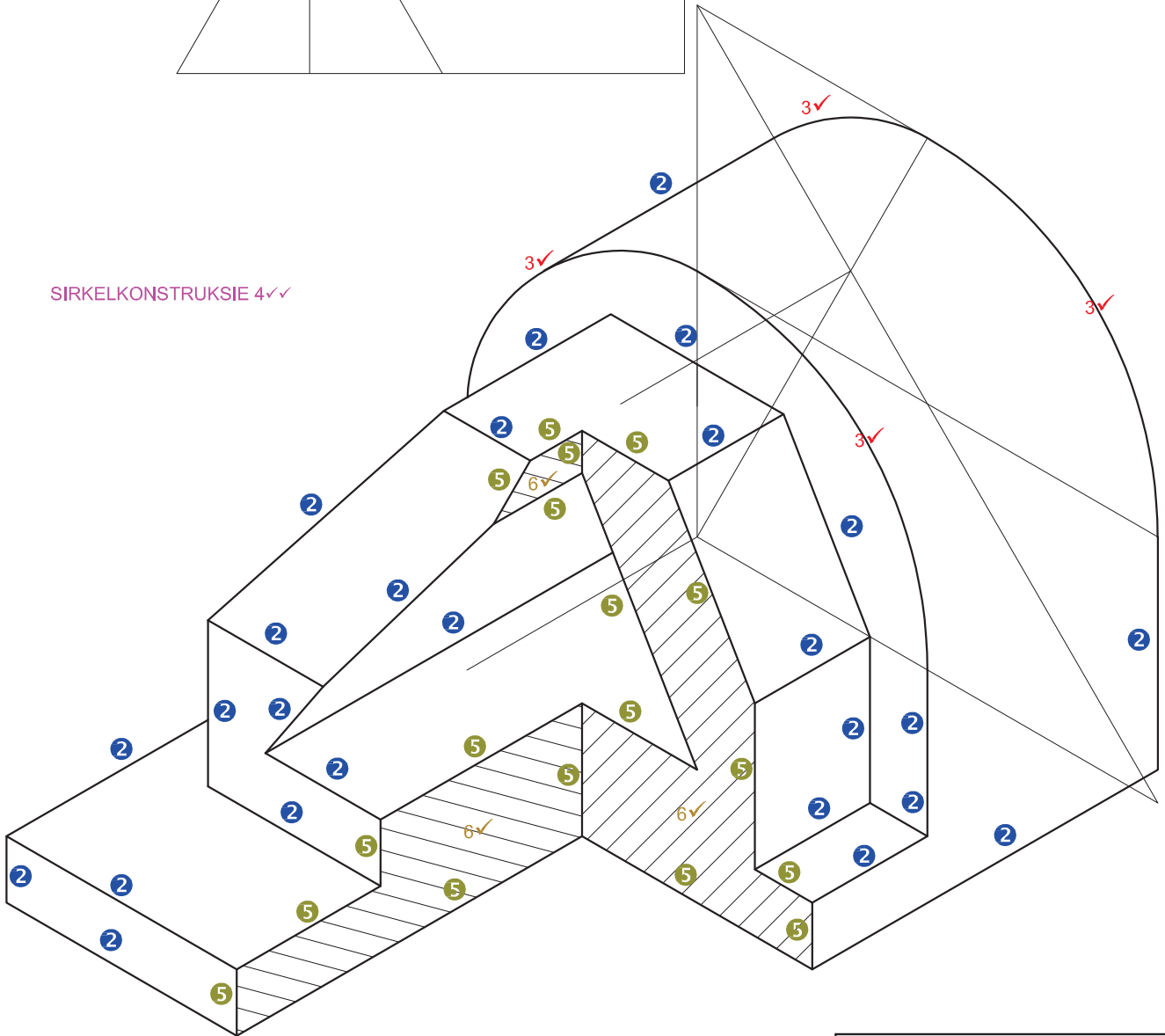

KORREKTE PLASING OP PUNT P 1✓

ARSERING KORREK AANGEDUI 6✓

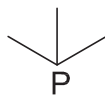

VRAESTEL 2 VRAAG 3
 GRAAD 12
 MODEL 2014
 MEMORANDUM

| ASSESSERINGSKRITERIA | | |
|----------------------|------------------------------------|-----------|
| 1. | HULPAANSIG + PLASING | 4 |
| 2. | ISOMETRIESE + NIE-ISOMETRIESE LYNE | 13 |
| 3. | ISOMETRIESE SIRKELS | 4 |
| 4. | SIRKELKONSTRUKSIES | 2 |
| 5. | GESNYDE VLAKKE | 9 |
| 6. | ARSERING | 4 |
| TOTAAL | | 36 |

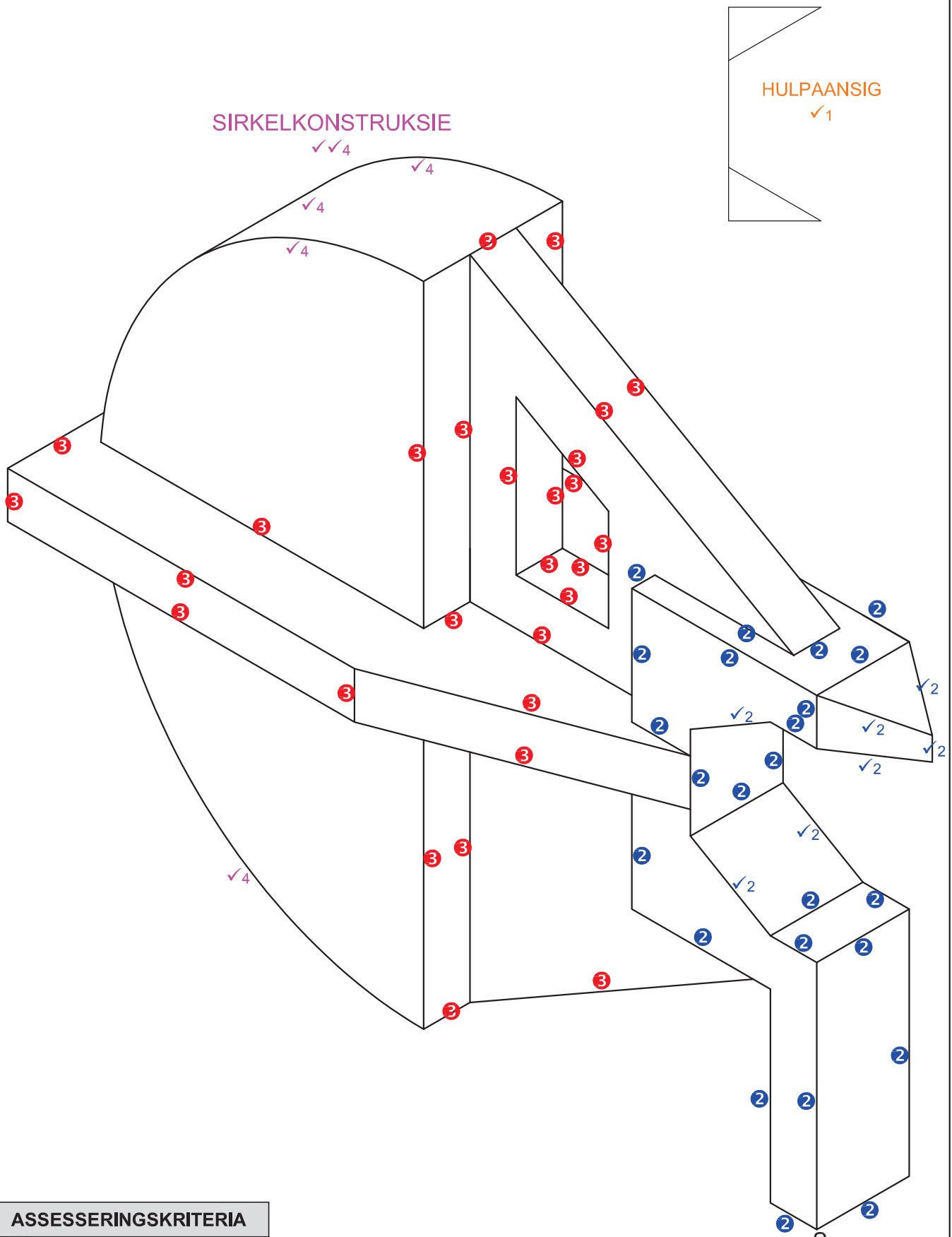

SIRKELKONSTRUKSIE

HULPAANSIG
✓1

S
PLASING
✓1

| ASSESSERINGSKRITERIA | | |
|----------------------|----------------------|-----------|
| 1 | HULPAANSIG + PLASING | 2 |
| 2 | VOOR | 19 |
| 3 | MIDDEL | 14 |
| 4 | KONSTR. + SIRKEL | 6 |
| TOTAAL | | 41 |

VRAESTEL 2 VRAAG 3
GRAAD 12
FEB. - MRT. 2014
MEMORANDUM

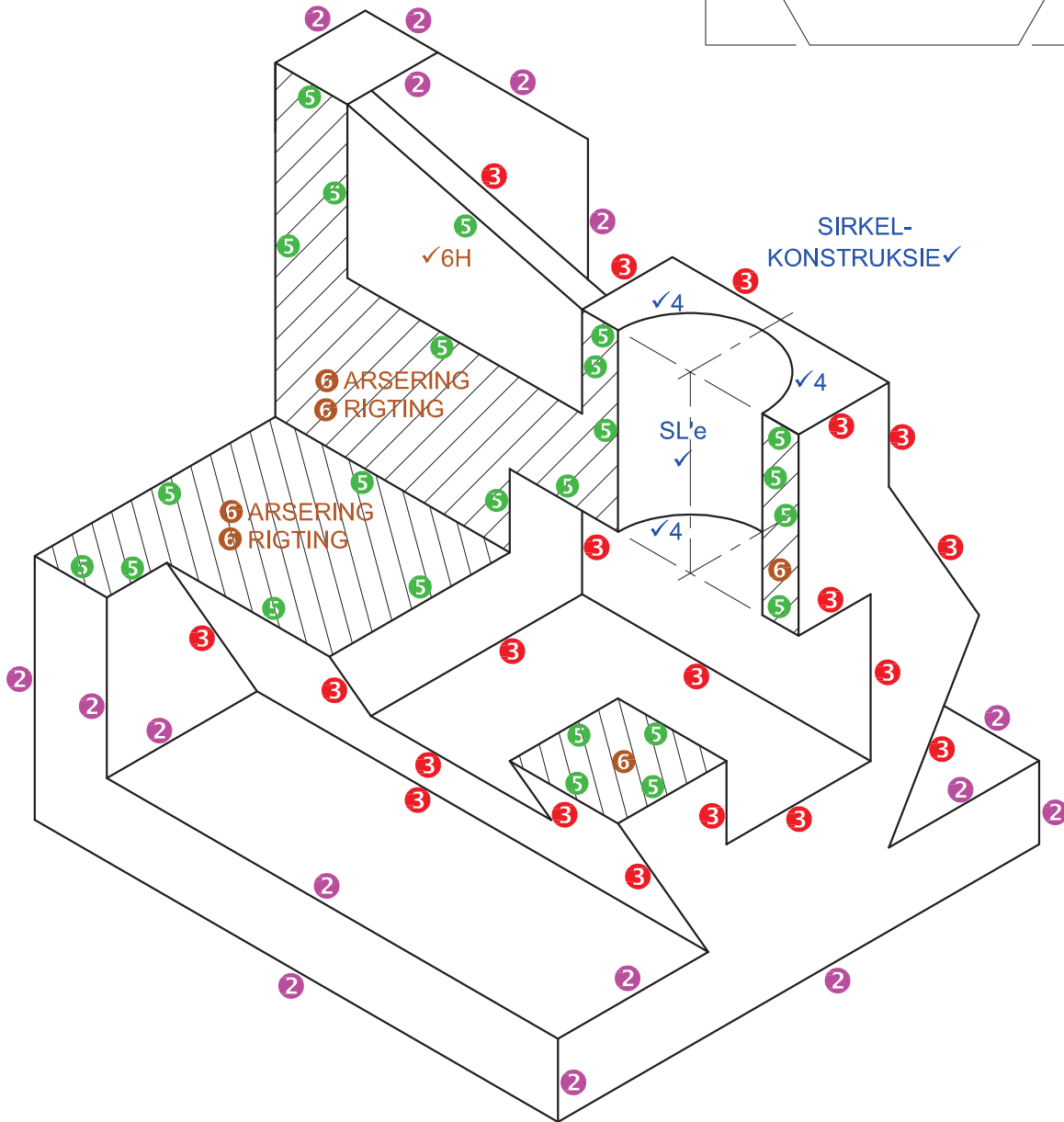
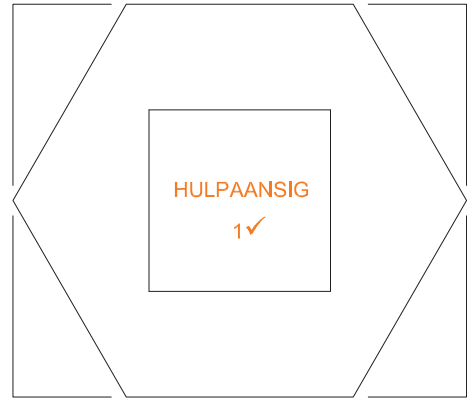

S
PLASING
1✓

| ASSESSERINGSKRITERIA | | |
|----------------------|----------------------|-----------|
| 1 | HULPAANSIG + PLASING | 2 |
| 2 | VOETSTUK | 8 |
| 3 | SESKANTIGE PRISMA | 10 |
| 4 | SIRKELS | 5 |
| 5 | SNIT | 12 |
| 6 | ARSERING | 4 |
| TOTAAL | | 41 |

VRAESTEL 2 VRAAG 3
GRAAD 12
November 2013
MEMORANDUM

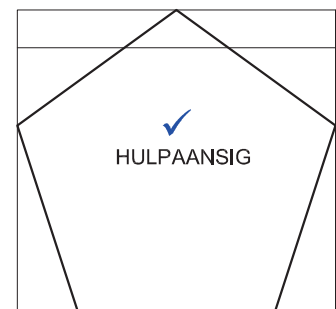
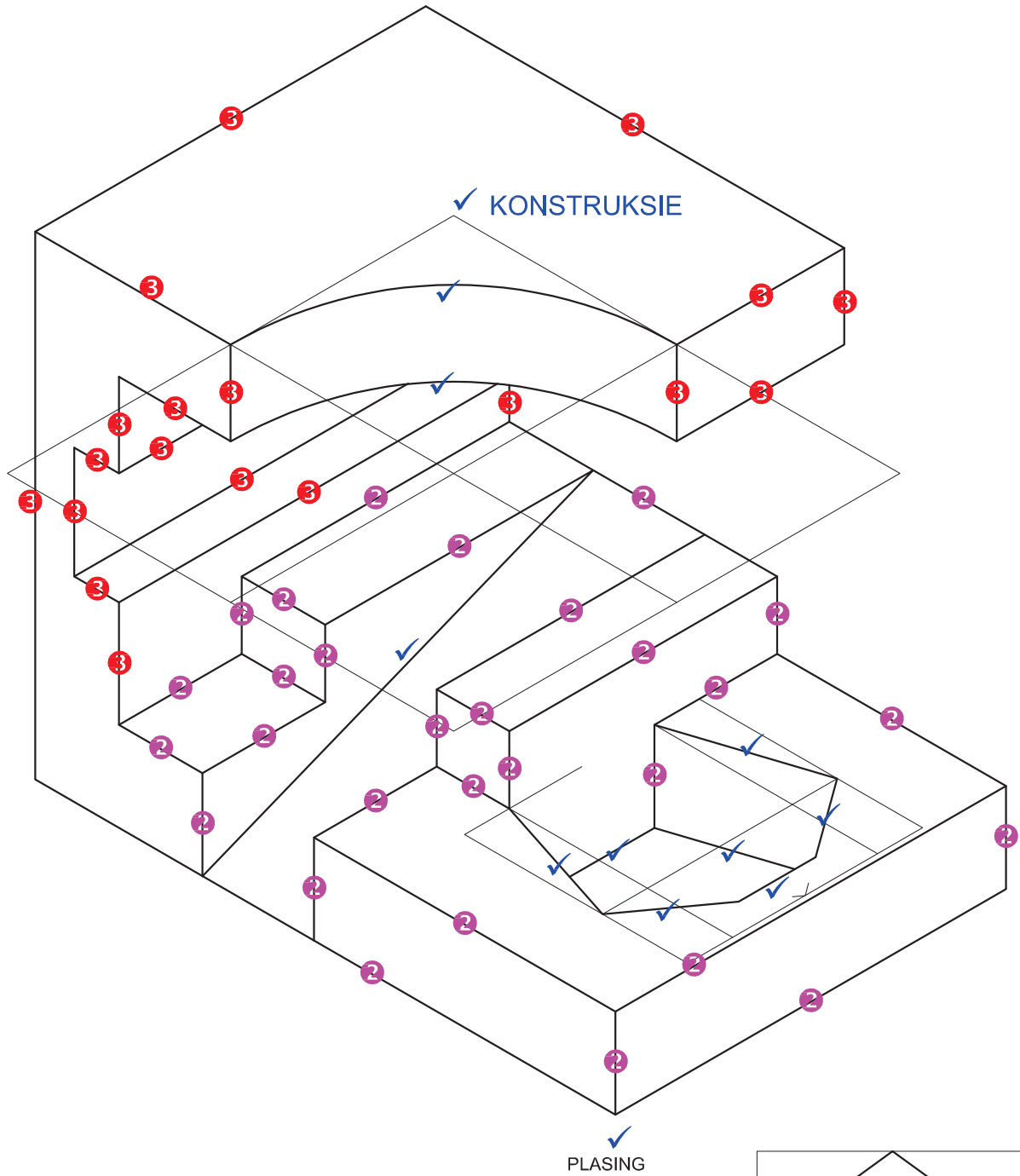

| ASSESSERINGSKRITERIA | | |
|----------------------|---------------------------------------|-----------|
| 1 | HULPAANSIG + SIRKEL-VYFKANT + PLASING | 12 |
| 2 | ONDERSTE GEDEELTE | 15½ |
| 3 | BOONSTE GEDEELTE | 9½ |
| TOTAAL | | 37 |

VRAESTEL 2 VRAAG 3
 GRAAD 12
 FEB. - MRT. 2013
 MEMORANDUM

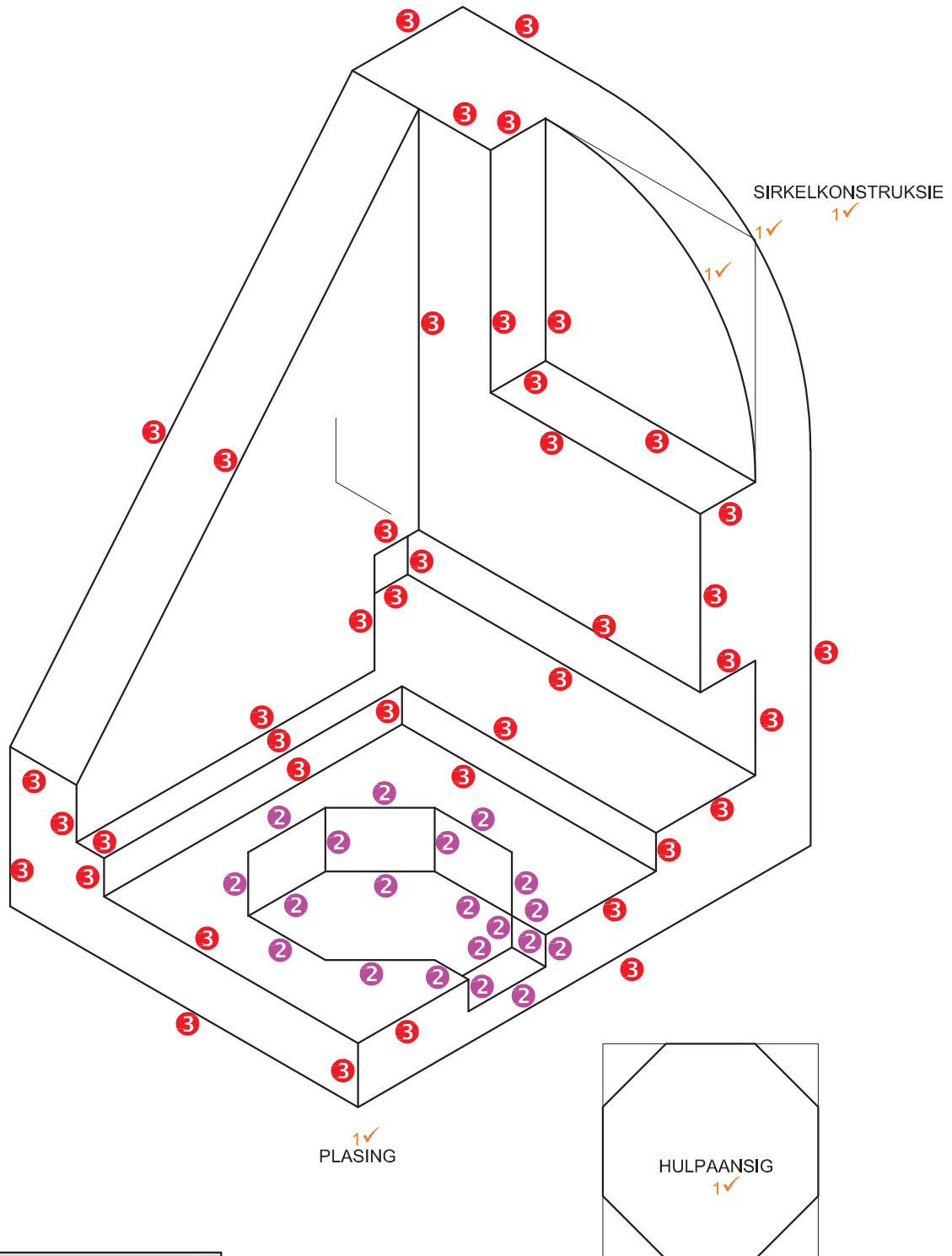

| ASSESSERINGSKRITERIA | | |
|----------------------|--|-----------|
| 1 | HULPAANSIGTE + SIRKEL + KONSTRUKSIES + PLASING | 5 |
| 2 | AGTKANTIGE GAT | 10 |
| 3 | ISO- + NIE-ISO'-LYNE | 21 |
| TOTAAL | | 36 |

VRAESTEL 2 VRAAG 3
 GRAAD 12
 NOVEMBER 2012
 MEMORANDUM

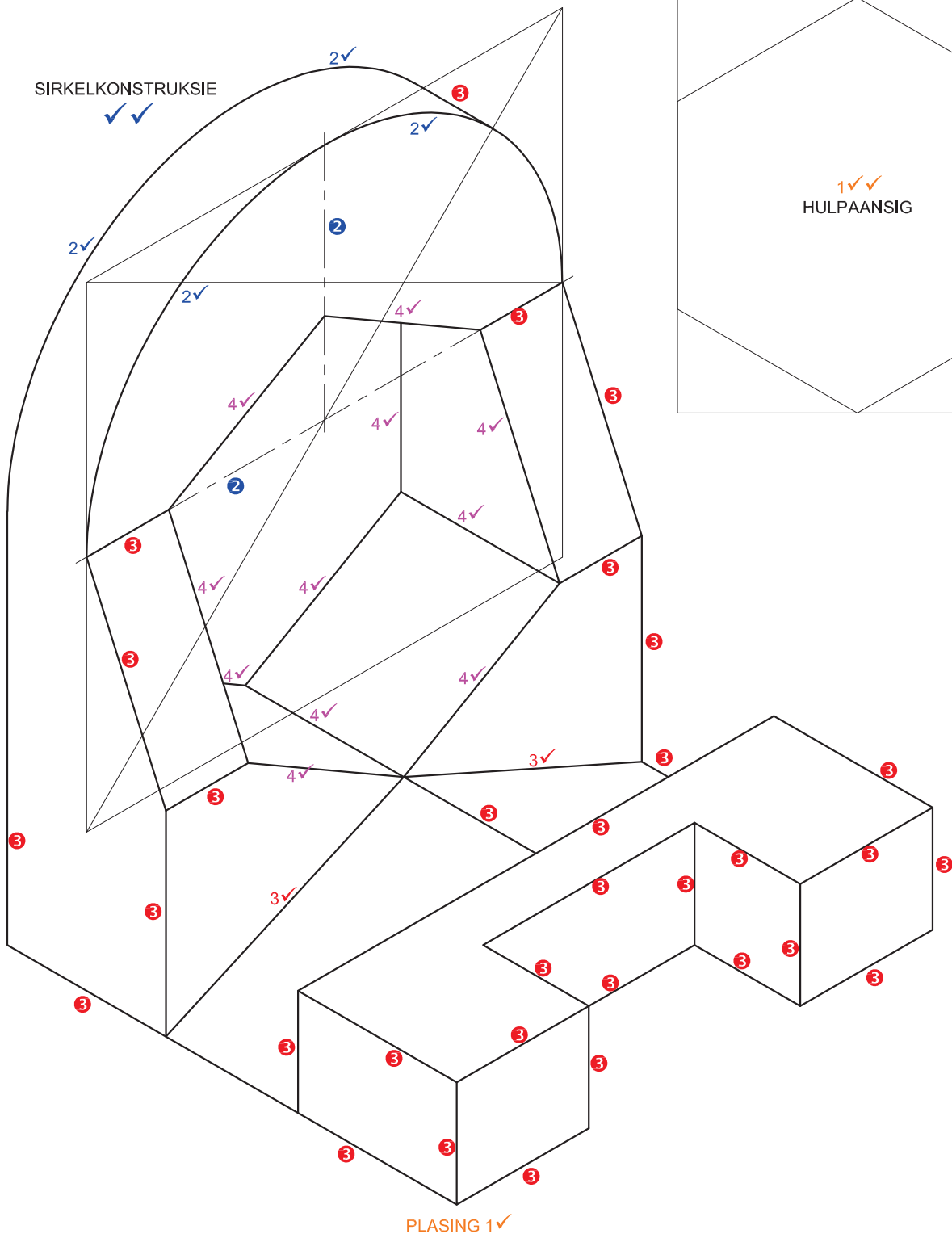

| ASSESSERINGSKRITERIA | |
|---|-----------|
| 1. HULPAANSIG + PLASING + SIRKELKONSTRUKSIE | 5 |
| 2. ISO-SIRKELS + SENTERLYNE | 5 |
| 3. ISO + NIE-ISO-LYNE | 18 |
| 4. SESKANT | 11 |
| TOTAAL | 39 |

VRAESTEL 2 VRAAG 3
 GRAAD 12
 Feb.-Mrt. 2012
 MEMORANDUM

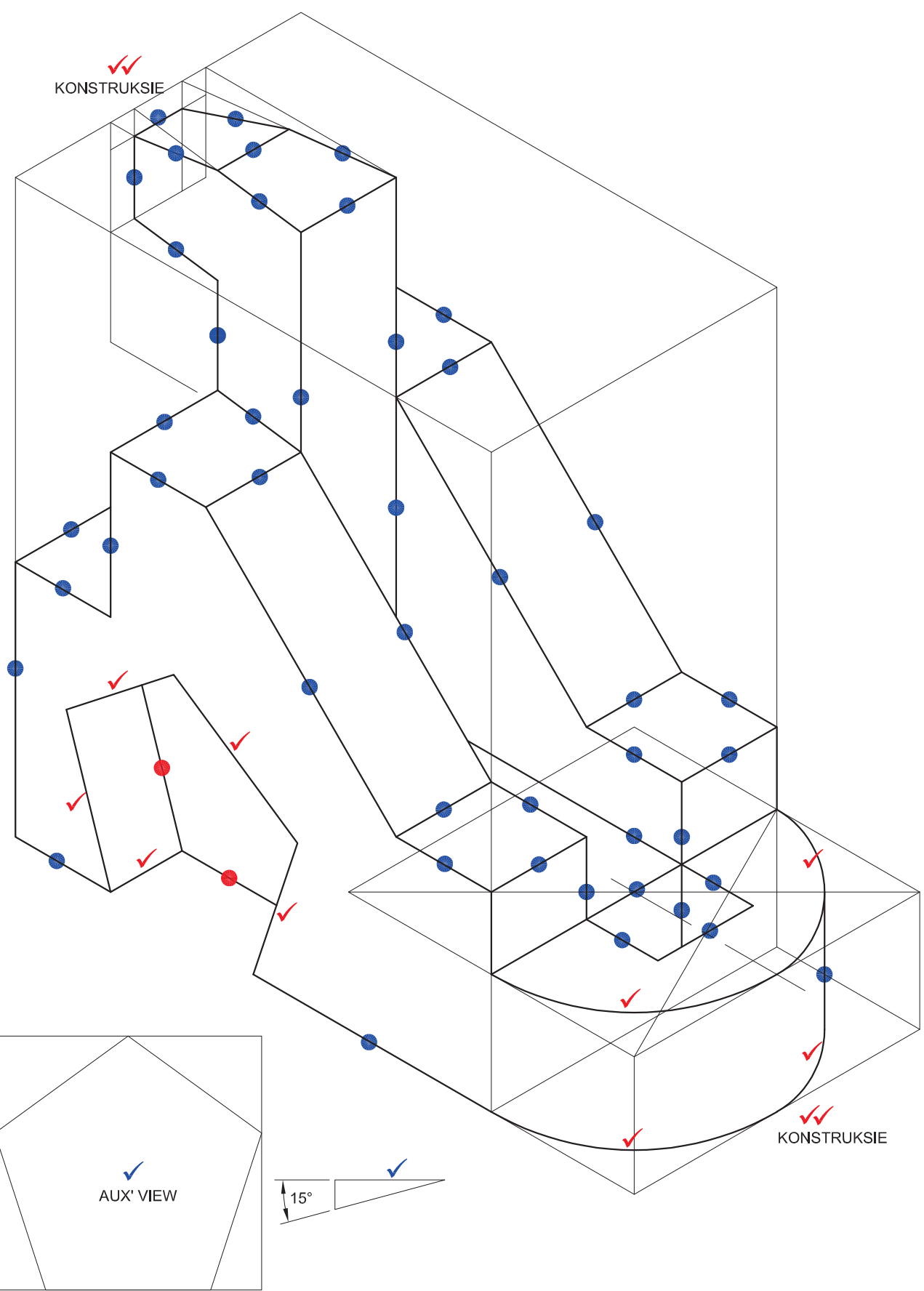

ASSESSERINGSKRITERIA

| | |
|----------------------------------|-----------|
| HULPAANSIG + SIRKEL KONSTRUKSIES | 6 |
| ISO KURWES + VYFKANTIGE GAT | 11 |
| ISO + NIE-ISO LYNE | 23 |
| TOTAAL | 40 |

VRAESTEL 2 VRAAG 3
 GRAAD 12
 NOVEMBER 2011
 MEMORANDUM

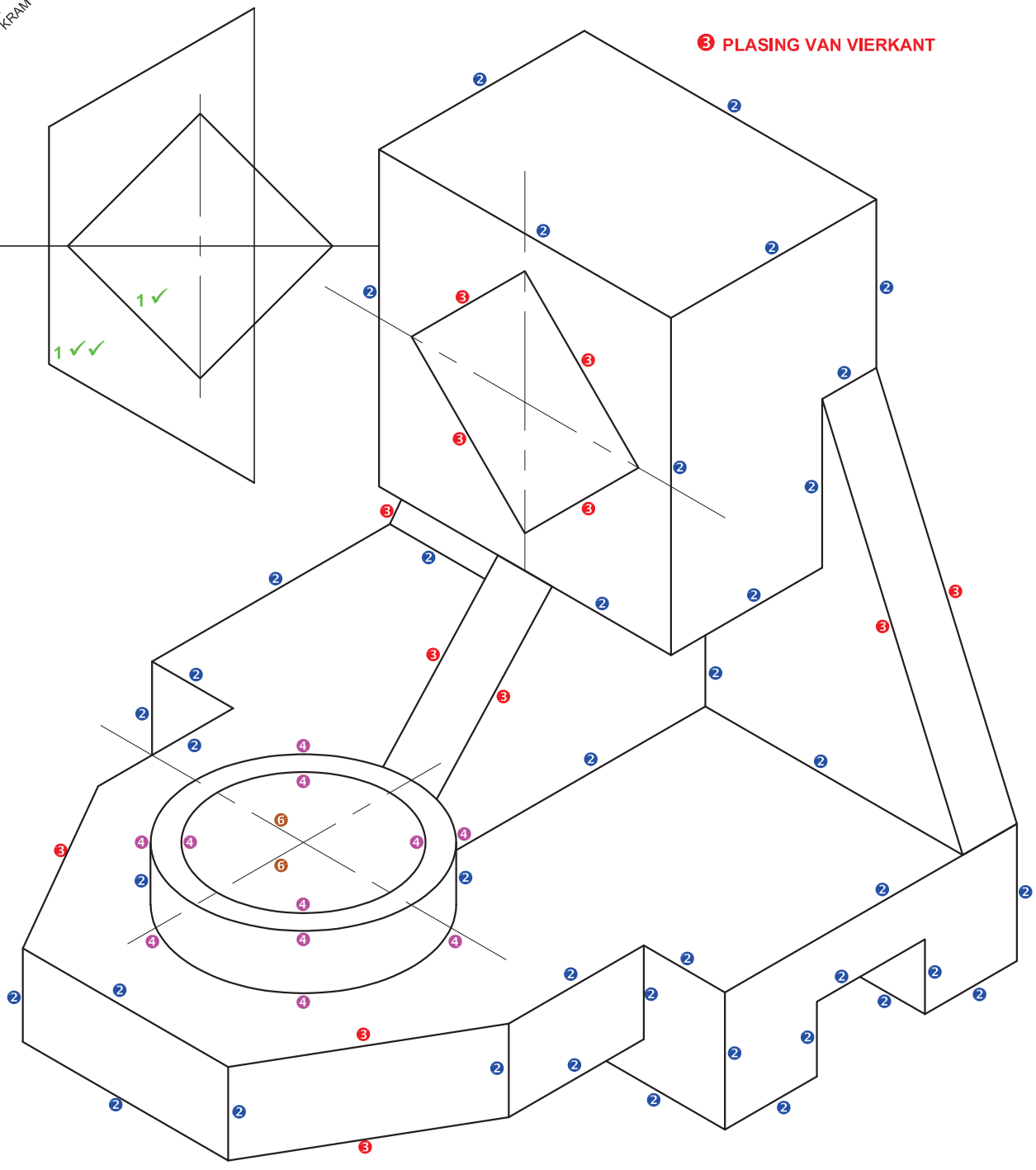

3 PLASING VAN VIERKANT

5 ✓✓ SIRKELKONSTRUKSIES

A 1 ✓ VIR KORREKTE PLASING OP A

| ASSESSERINGSKRITERIA | |
|-------------------------|-----------|
| 1. HULPAANSIG + PLASING | 4 |
| 2. ISOMETRIESE LYNE | 20 |
| 3. NIE-ISOMETRIESE LYNE | 6½ |
| 4. ISOMETRIESE SIRKELS | 5½ |
| 5. SIRKELKONSTRUKSIE | 2 |
| 6. SENTERLYNE | 1 |
| TOTAL | 39 |

VRAESTEL 2 VRAAG 3
 GRAAD 12
 FEBRUARIE/MAART 2011
 MEMORANDUM

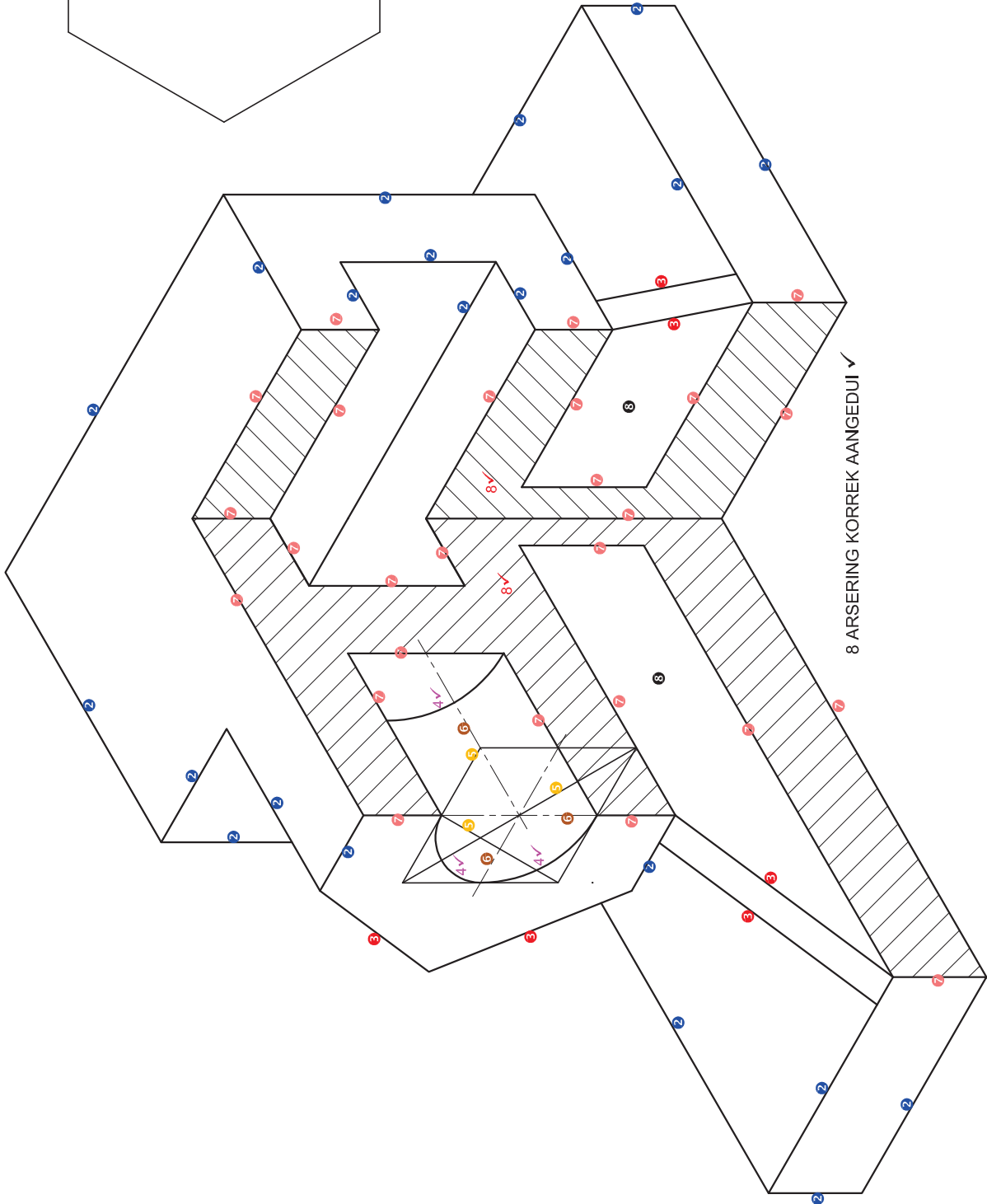
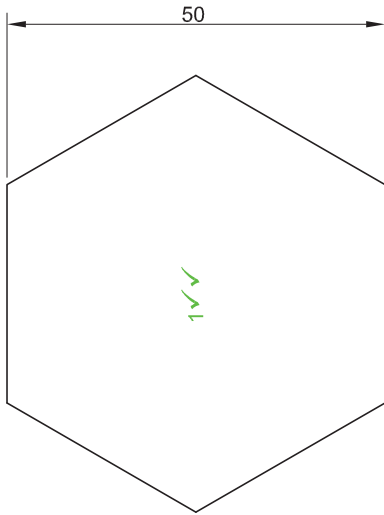

8 ARSERING KORREK AANGEDUI ✓

1 KORREKTE PLASING OP PUNT B ✓

| ASSESSERINGSKRITERIA | |
|-------------------------|-----------|
| 1. HULPAANSIG + PLASING | 3 |
| 2. ISOMETRIESE LYNE | 11 |
| 3. NIE-ISOMETRIESE LYNE | 3 |
| 4. ISOMETRIESE SIRKELS | 3 |
| 5. SIRKELKONSTRUKSIES | 1½ |
| 6. SENTERLYNE | 1½ |
| 7. GESNYDE VLAKKE | 13 |
| 8. ARSERING | 4 |
| TOTAAL | 40 |

VRAESTEL 2 VRAAG 3
 GRAAD 12
 NOVEMBER 2010
 MEMORANDUM

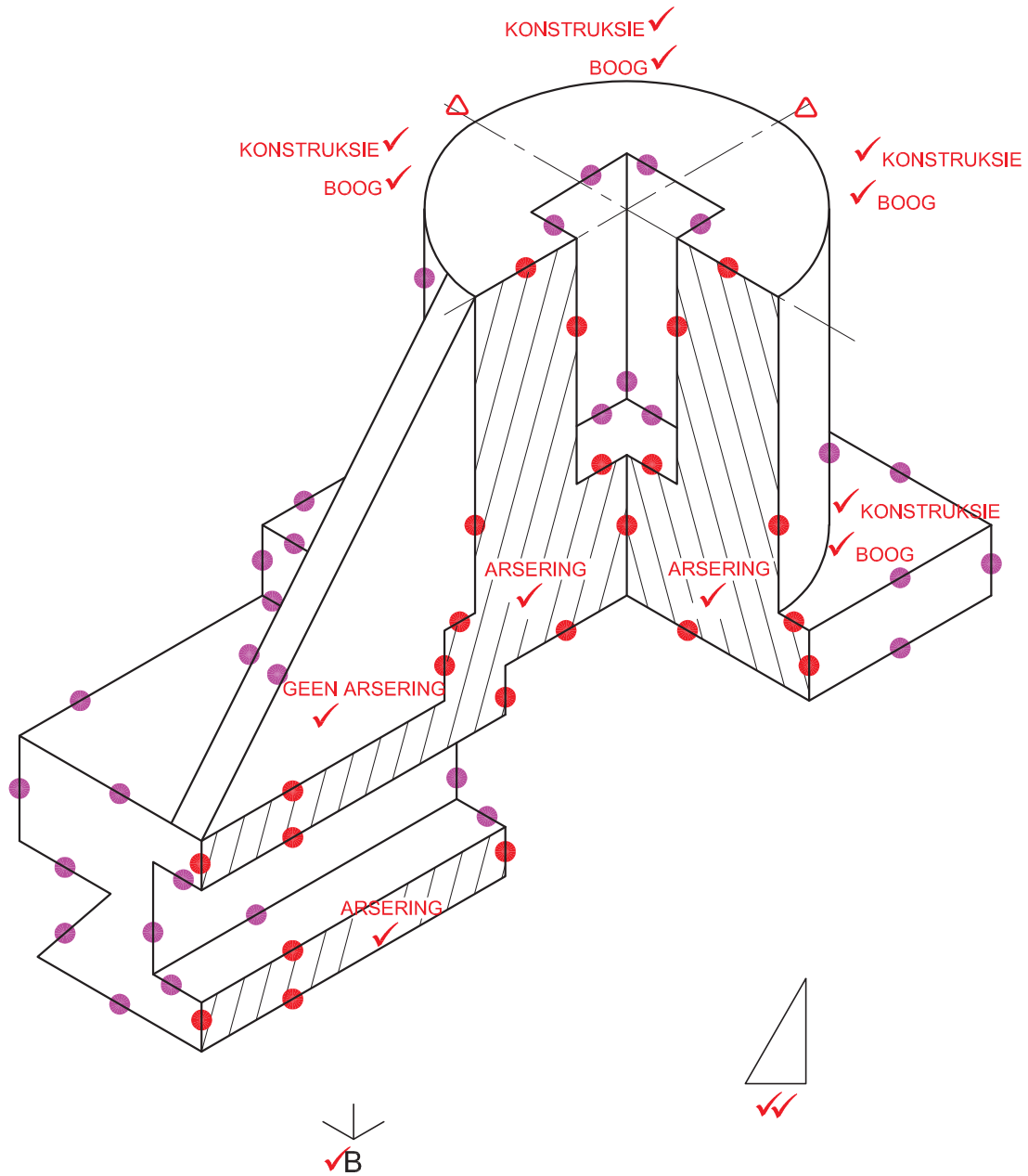

ASSESSERINGSKRITERIA

| | |
|-------------------------------------|-----------|
| HULPAANSIG+ PLASING | 3 |
| ISO' SIRKELS + KONSTR' + SENTERLYNE | 9 |
| ISO' + NIE-ISO' LYNE | 15½ |
| GESNYDE VLAKKE | 11½ |
| ARSERING/GEEN ARSERING | 4 |
| TOTAAL | 43 |

VRAESTEL 2 VRAAG 3
 GRAAD 12
 FEBRUARIE/MAART 2010
 MEMORANDUM

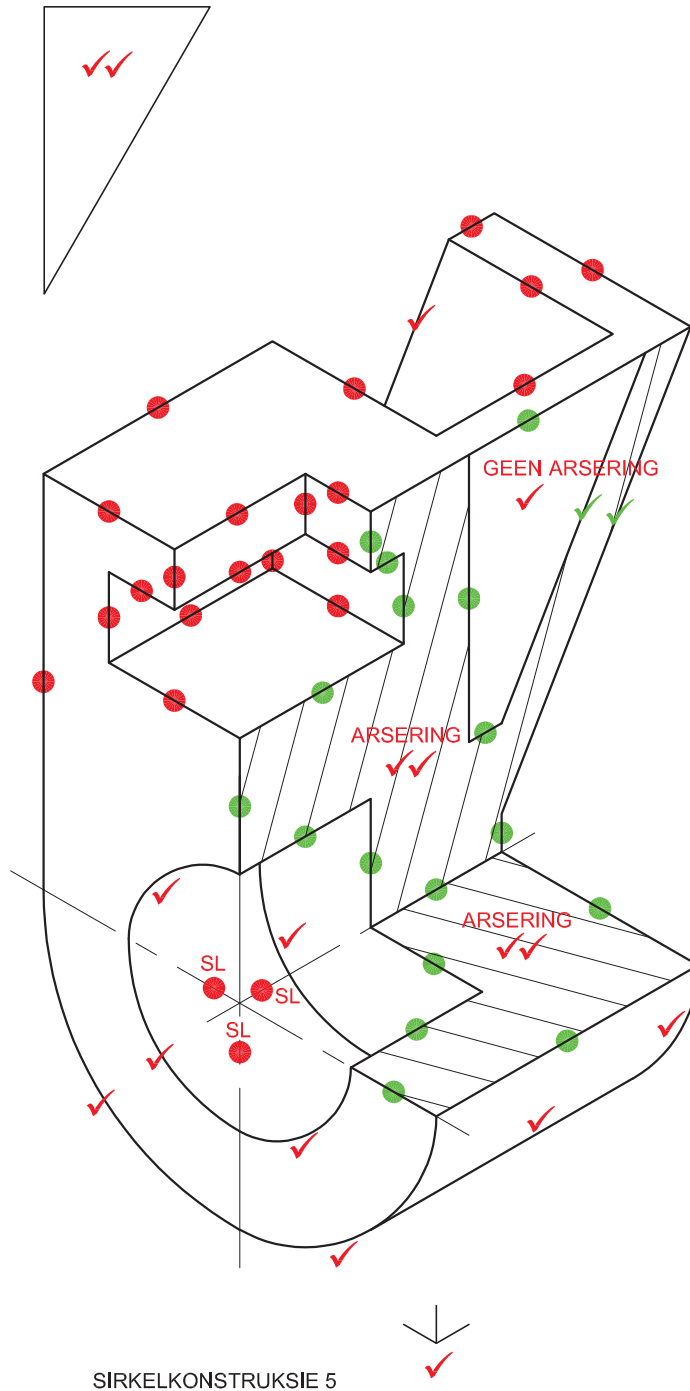

SIRKELKONSTRUKSIE 5

ASSESSERINGSKRITERIA

| | |
|----------------------------------|-----------|
| KONSTRUKSIE + HULPAANSIG + B | 8 |
| ISOMETRIESE SIRKELS + SENTERLYNE | 8½ |
| ISO' + NIE-ISOMETRIESE LYNE | 12 |
| SNITVLAKKE | 10½ |
| ARSERING | 5 |
| TOTAAL | 44 |

VRAESTEL 2 VRAAG 3
GRAAD 12 NOVEMBER 2009
MEMORANDUM

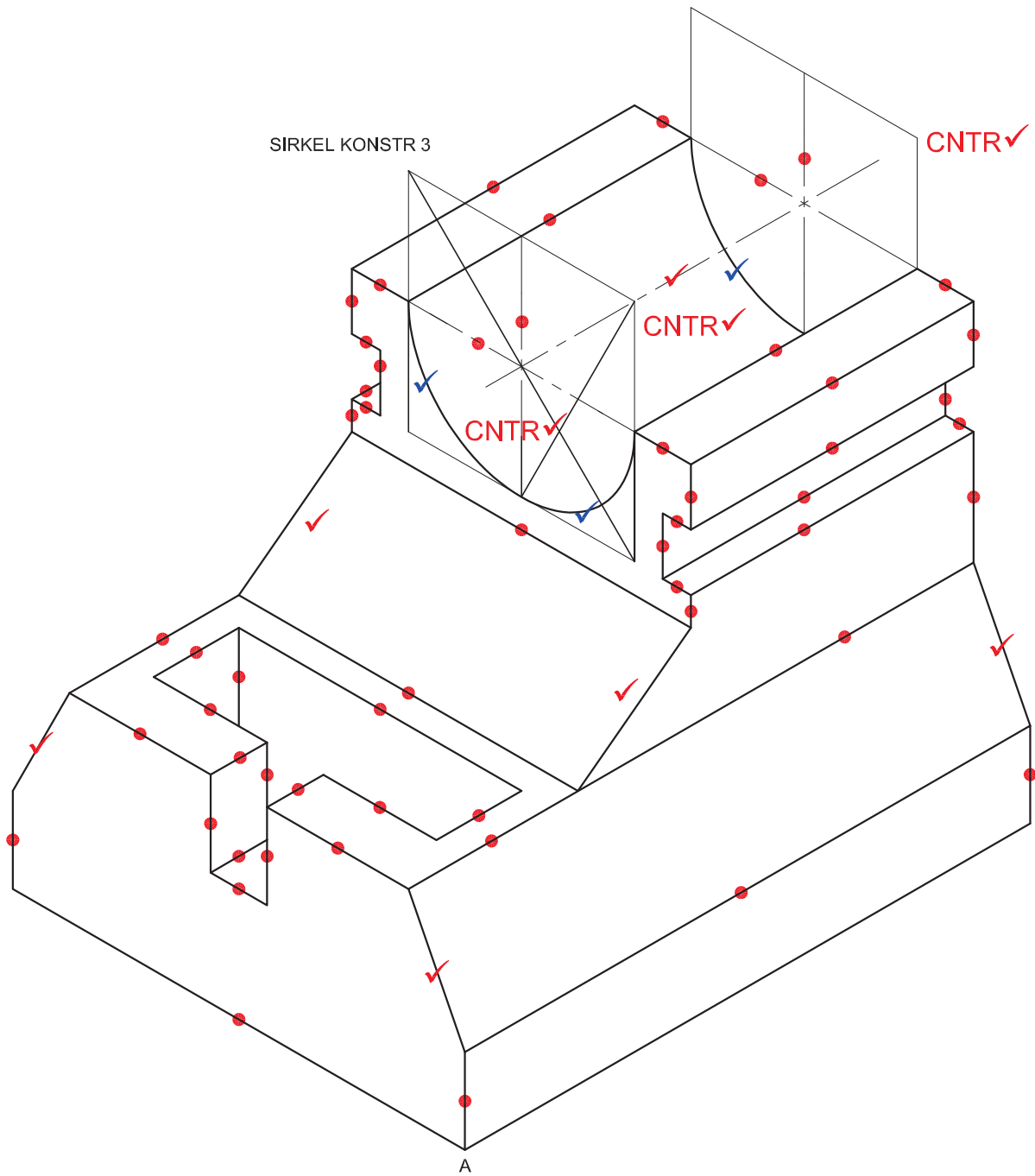

ASSESSERINGSKRITERIA

| | |
|---------------------|-------------|
| HULPAANSIG | = 2 |
| ISOMETRIESELYNE | = 26 |
| NIE-ISOMETRIESELYNE | = 5 |
| ISOMETRIESE SIRKLES | = 3 |
| SIRKEL KONSTRUKSIE | = 3 |
| SENERLYNE | = 3 |
| PLASING OP A | = 1 |
| TOTAAL | = 43 |



VRAESTEL 2 VRAAG 3
 GRAAD 12
 FEBRUARIE/MAART 2009
 MEMORANDUM

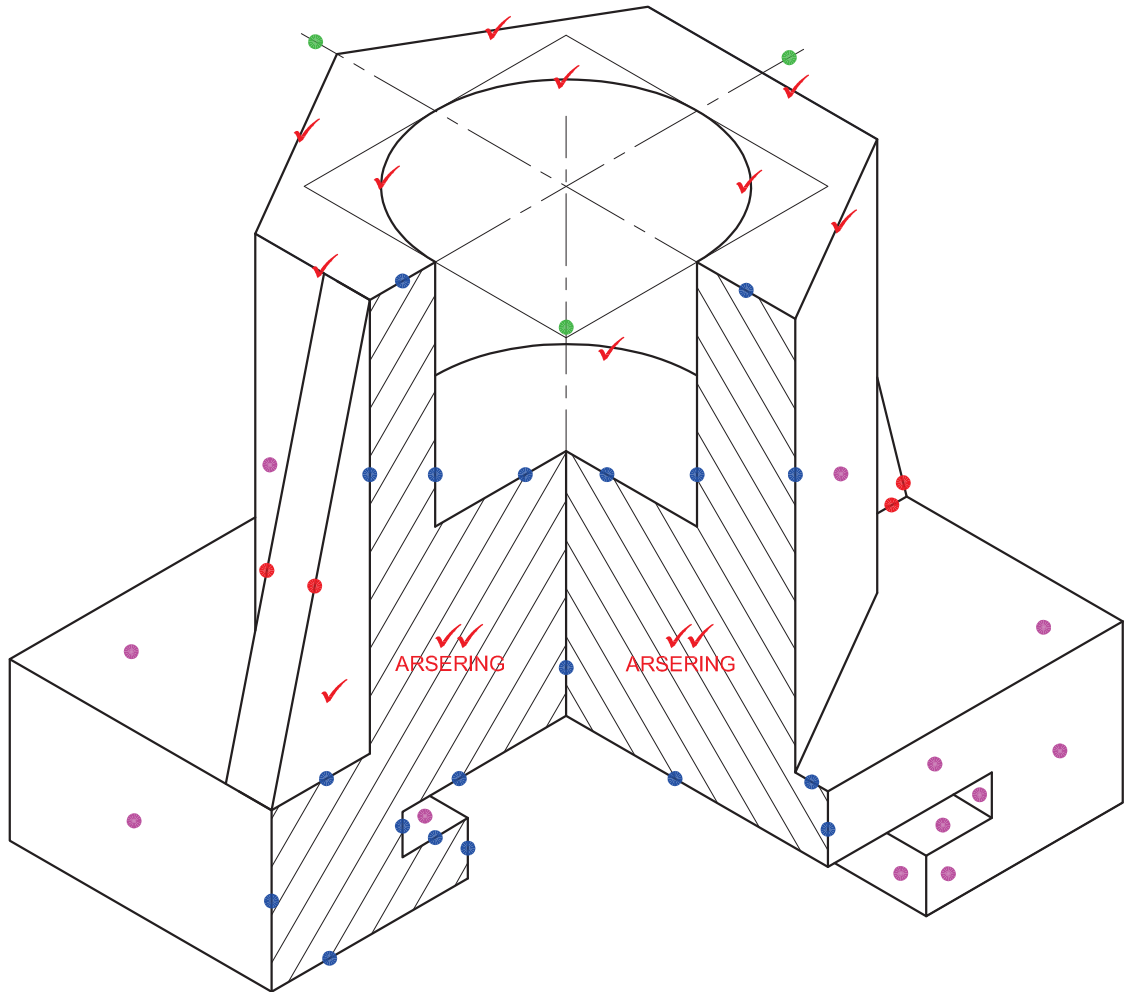

↓
A

ASSESSERINGSKRITERIA

| | |
|----------------------|-------------|
| HULPAANSIG | = 2 |
| ISOMETRIESE VLAKKE | = 6 |
| NIE-ISOMETRIESE LYNE | = 2 |
| GESNYDE VLAKKE | = 9½ |
| ISOMETRIESE SIRKELS | = 4 |
| SIRKELKONSTRUKSIE | = 3 |
| ARSERING | = 4 |
| SENERLYNE | = 2½ |
| SESKANT | = 5 |
| PLASING OP A | = 2 |
| TOTAAL | = 40 |

VRAAG 3 VRAESTEL 2
 GRAAD 12 NOVEMBER 2008
 MEMORANDUM

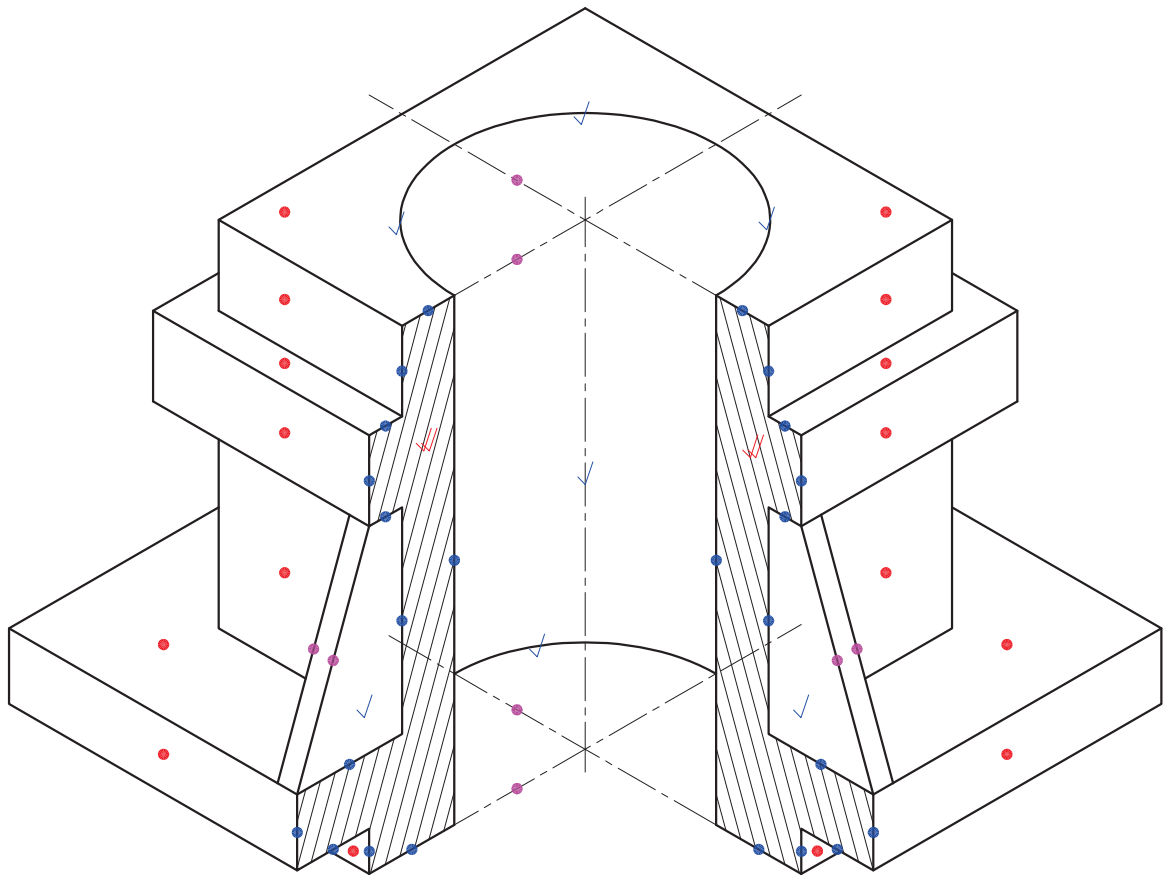
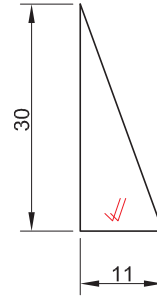

ASSESSERINGSKRITERIA

| | |
|-------------------------|-------------|
| HULPAANSIG | = 2 |
| ISOMETRIESE OPPERVLAKKE | = 8 |
| NIE-ISOMETRIESE LYNE | = 2 |
| SNIT | = 12 |
| ISOMETRIESE SIRKELS | = 4 |
| SIRKELKONSTRUKSIE | = 4 |
| ARSERING | = 6 |
| SENTERLYNE | = 2 |
| TOTAAL | = 40 |

2008 GRAAD 12
 VRAESTEL 2
 MODEL
 VRAAG 3
 MEMORANDUM