

ASSESSERINGSKRITERIA		
1	KONSTRUKSIE	6
2	VLOER	11
3	MURE	8 1/2
4	DAK	4 1/2
5	VENSTERS + BOË	10
TOTAAL		40

VRAESTEL 1 VRAAG 3
 GRAAD 12
 NOVEMBER 2023
 NASIENRIGLYNE

ASSESSERINGSKRITERIA

1	KONSTRUKSIE	6
2	STOEP + MURE	12 $\frac{1}{2}$
3	BOOG + KONSTR	8 $\frac{1}{2}$
4	VENSTER	3 $\frac{1}{2}$
5	DAK	9 $\frac{1}{2}$
TOTAAL		40

VRAESTEL 1 VRAAG 3
GRAAD 12
2023
NASIENRIGLYNE

RVP

PP

HL

GL

SP+

KURWE KWALITEIT 5

SP+

LVP

ASSESSERINGSKRITERIA		
1	KONSTRUKSIE	6
2	MUUR + BASIS	10 $\frac{1}{2}$
3	VENSTERS + OPENING	10
4	DAK	7 $\frac{1}{2}$
5	BOOG	7
TOTAAL		41

VRAESTEL 1 VRAAG 3
 GRAAD 12
 NOVEMBER 2022
 NASIENRIGLYNE

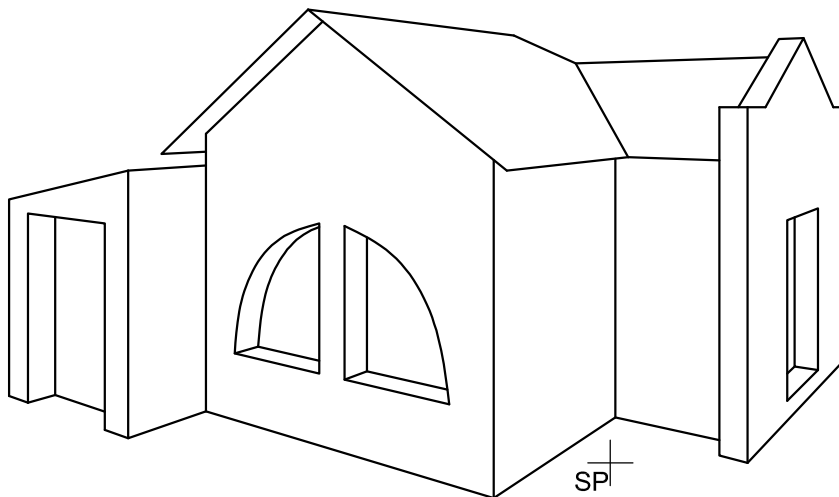
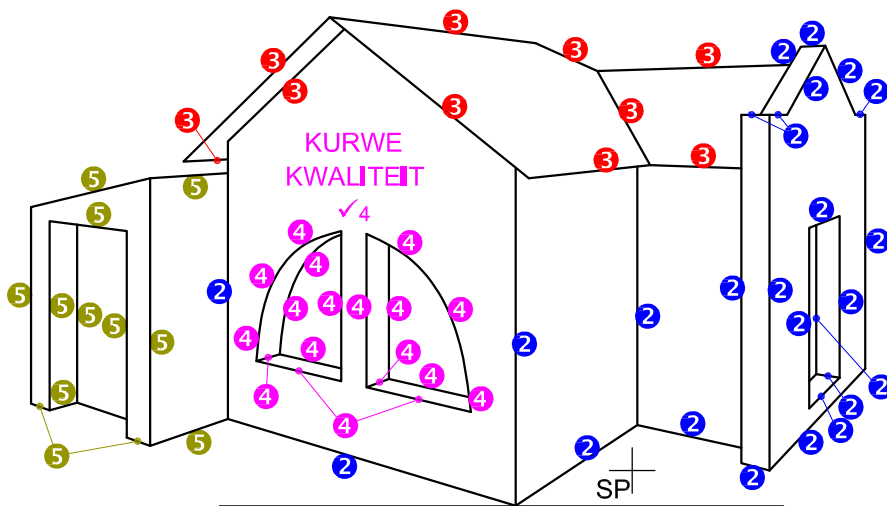
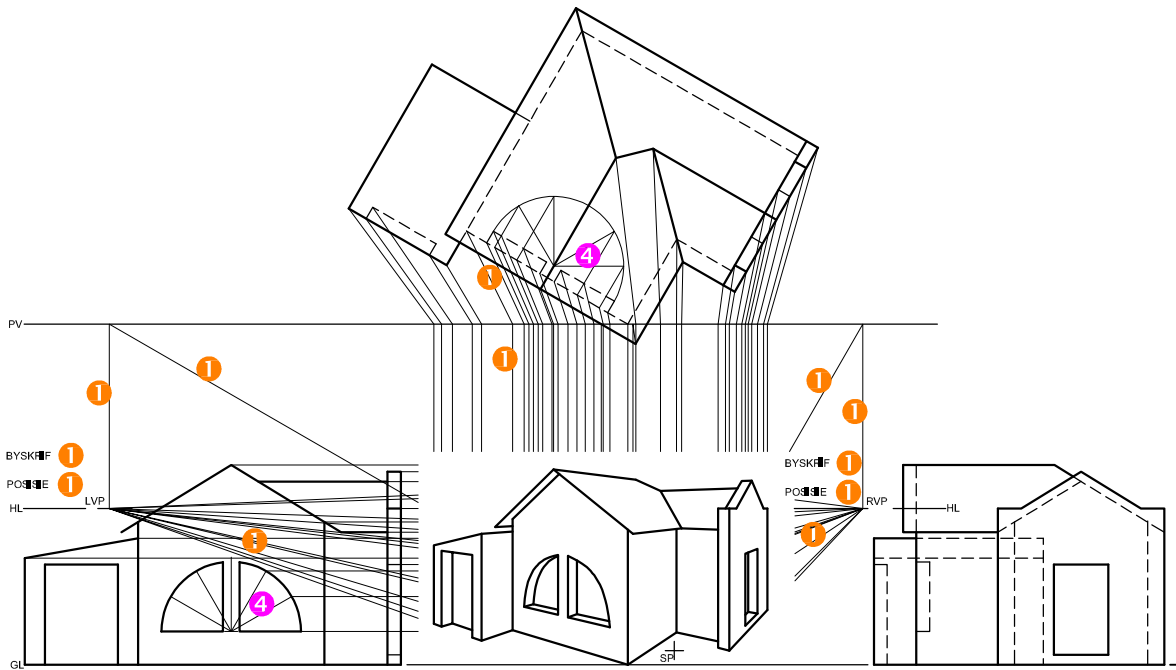

ASSESSERINGSKRITERIA		
1	KONSTRUKSIE	6
2	MURE	11 ½
3	DAK	5
4	VENSTERS	10
5	MOTORHUIS	5 ½
TOTAAL		38

VRAESTEL 1 VRAAG 3
 GRAAD 12
 2022
 NASIENRIGLYNE

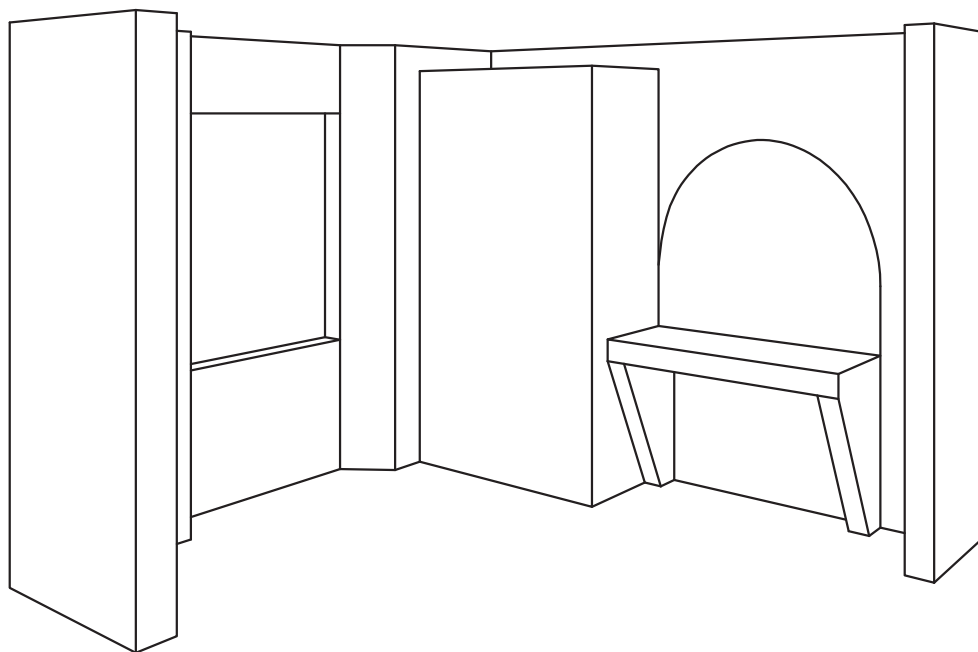
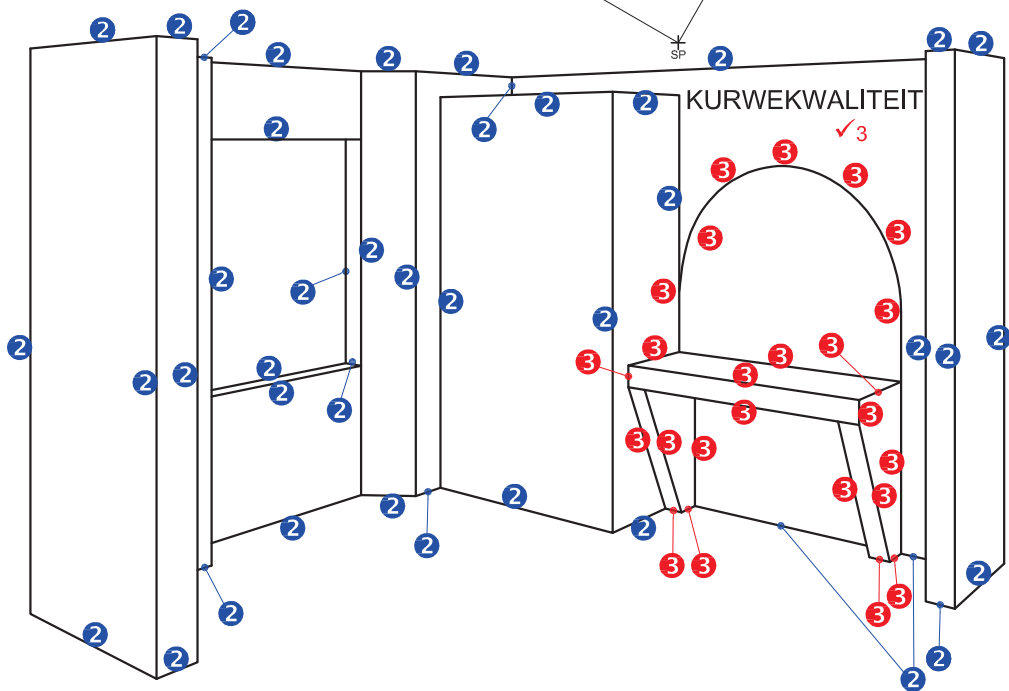
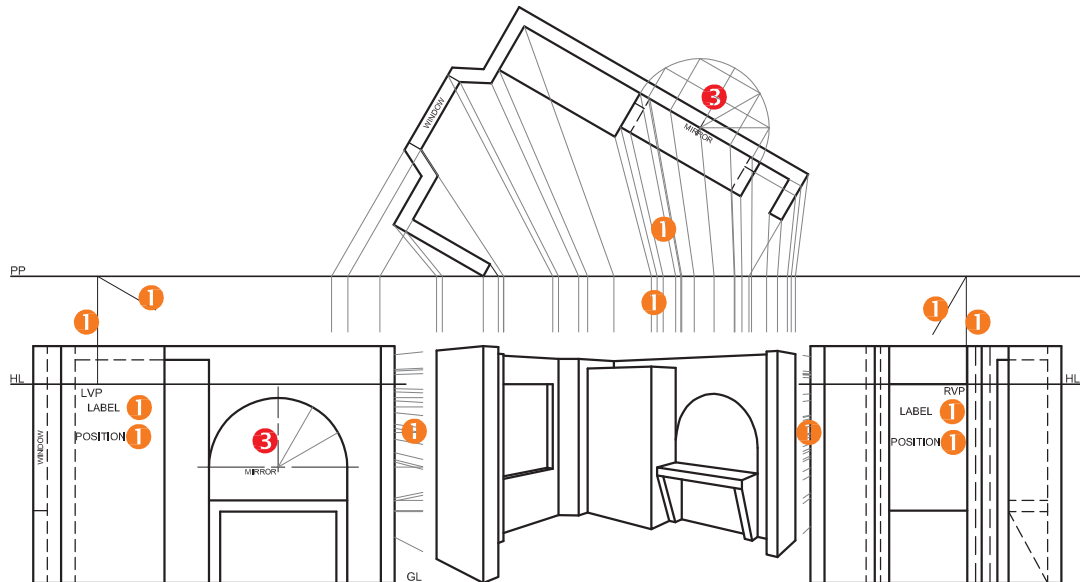

VRAESTEL 1 VRAAG 3
 GRAAD 12
 NOVEMBER 2021
 NASIENRIGLYNE

ASSESSERINGSKRITERIA		
1	KONSTRUKSIE	6
2	MURE + KAS + VENSTER	20
3	TAFEL + SPIEËL	14
TOTAAL		40

✓5 CURVE QUALITY

ASSESSMENT CRITERIA		
1	CONSTRUCTION	6
2	LOWER SECTION	15
3	UPPER SECTION	6
4	ROOF	4 $\frac{1}{2}$
5	ARC	7 $\frac{1}{2}$
TOTAL		39

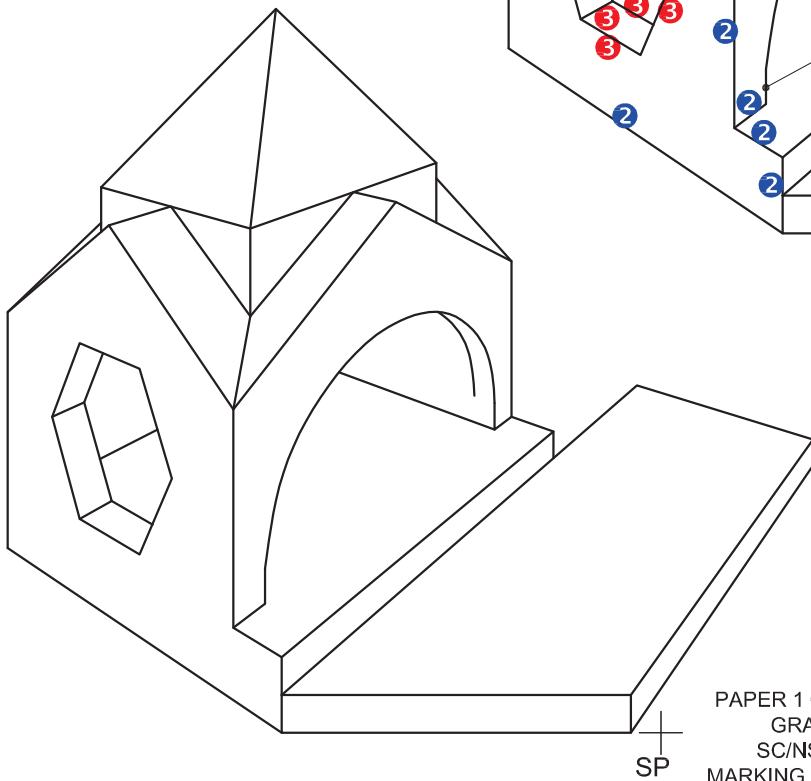
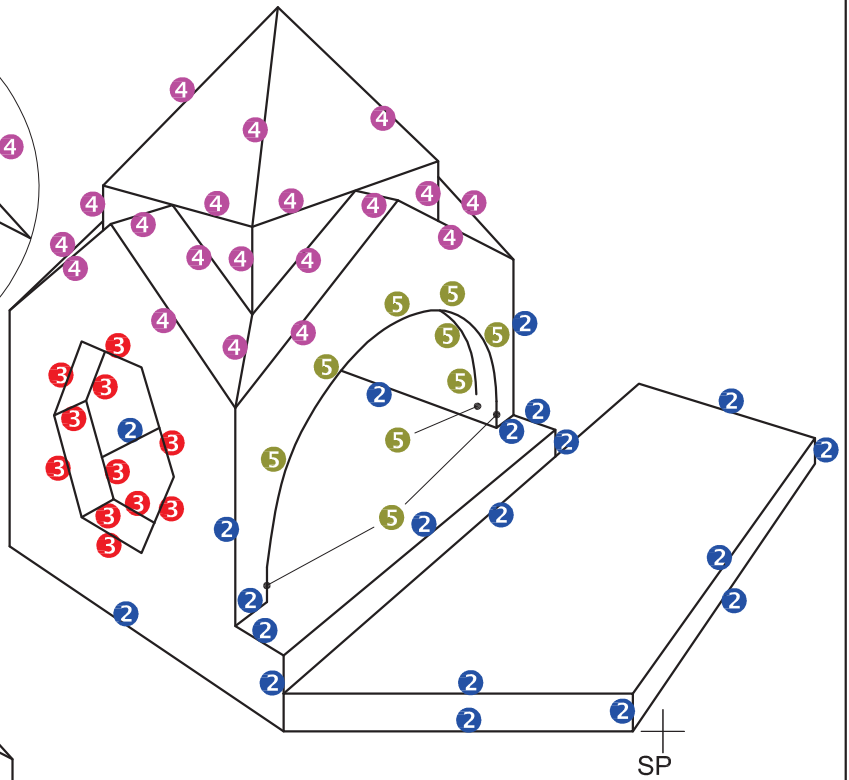
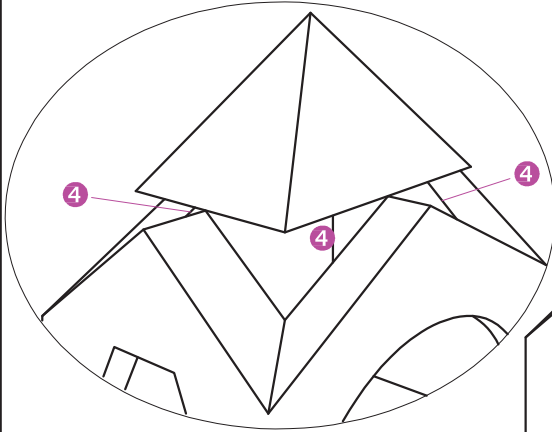
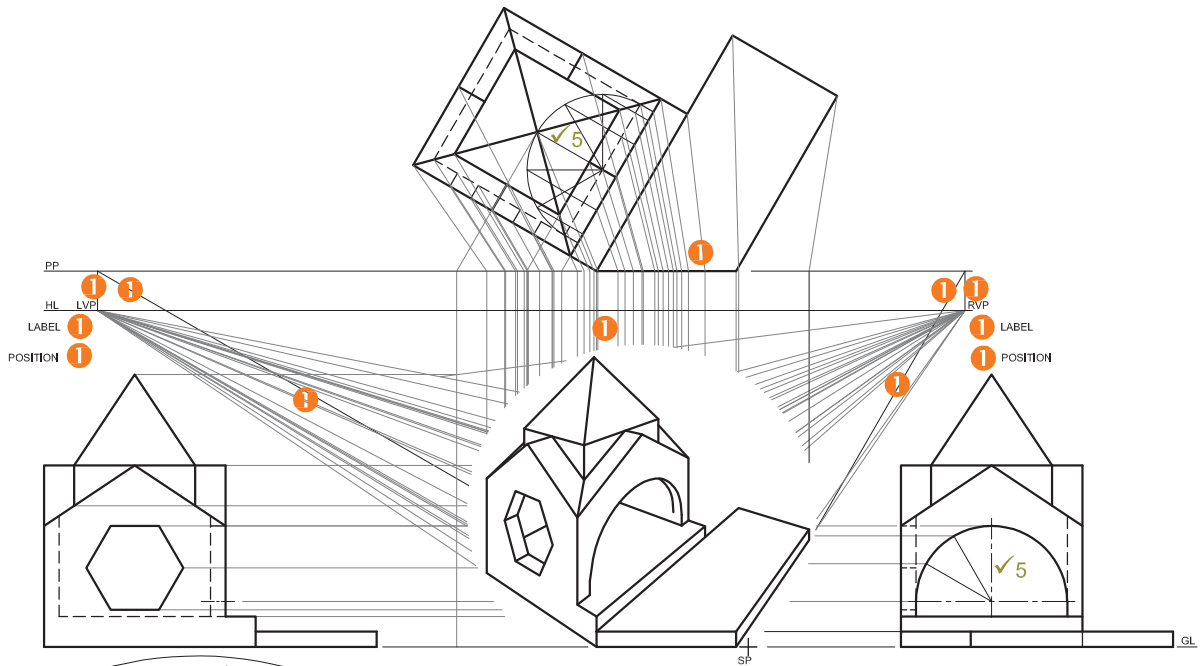

PAPER 1 QUESTION 3
 GRADE 12
 SC/NSC 2020
 MARKING GUIDELINES

ASSESSMENT CRITERIA		
1	CONSTRUCTION	6
2	WALLS	10½
3	HEXAGONAL OPENING	5½
4	ROOF	9½
5	CURVE	6½
TOTAL		38

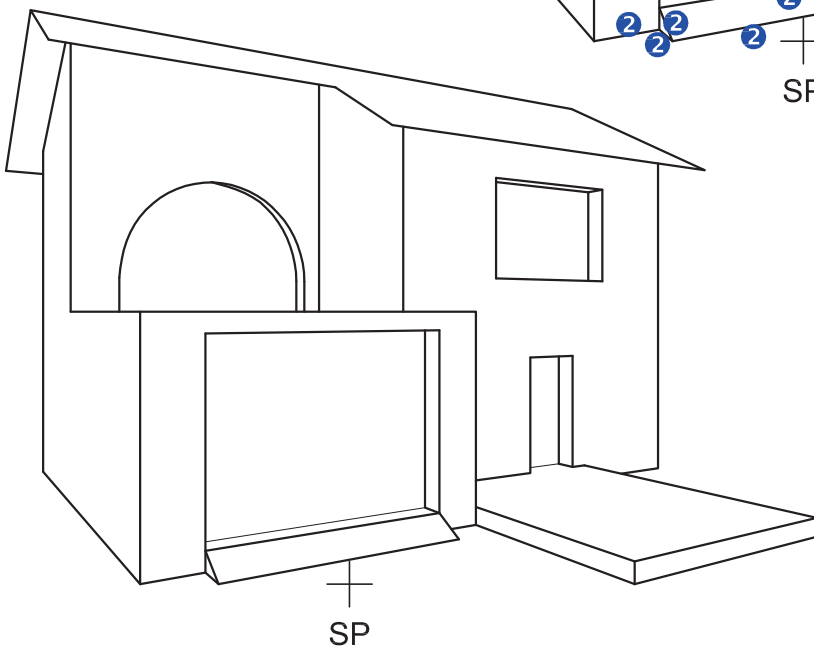
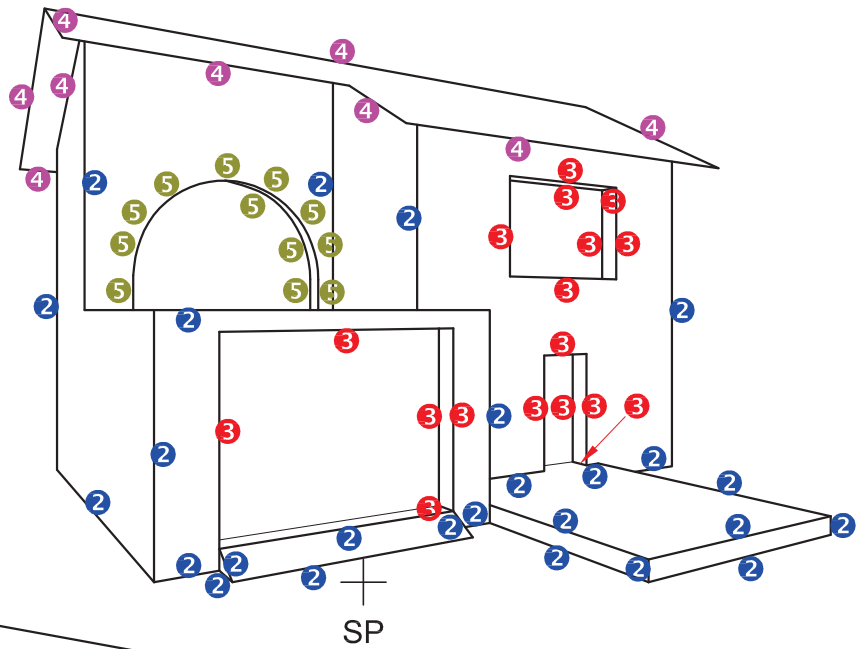
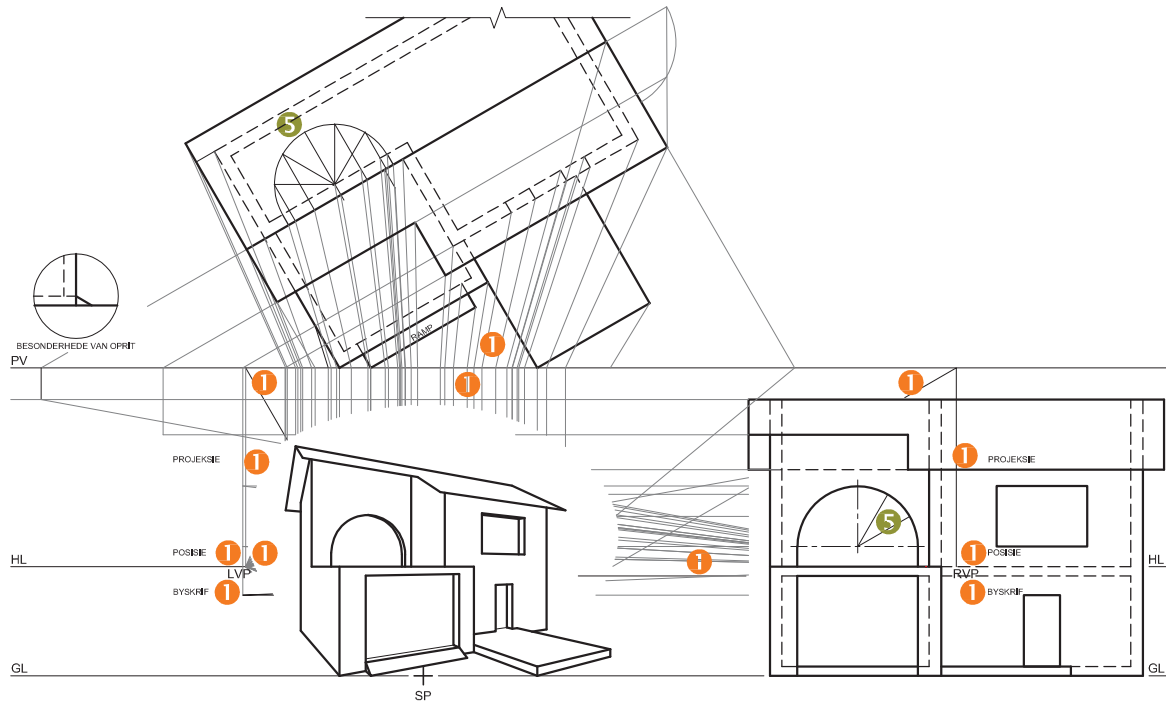

ASSESSERINGSKRITERIA		
1	KONSTRUKSIE	6
2	MURE	13
3	DEURE + VENSTERS	8½
4	DAK	4½
5	BOË	7
TOTAAL		39

VRAESTEL 1 VRAAG 3
 GRAAD 12
 NOVEMBER 2019
 NASIENRIGLYNE

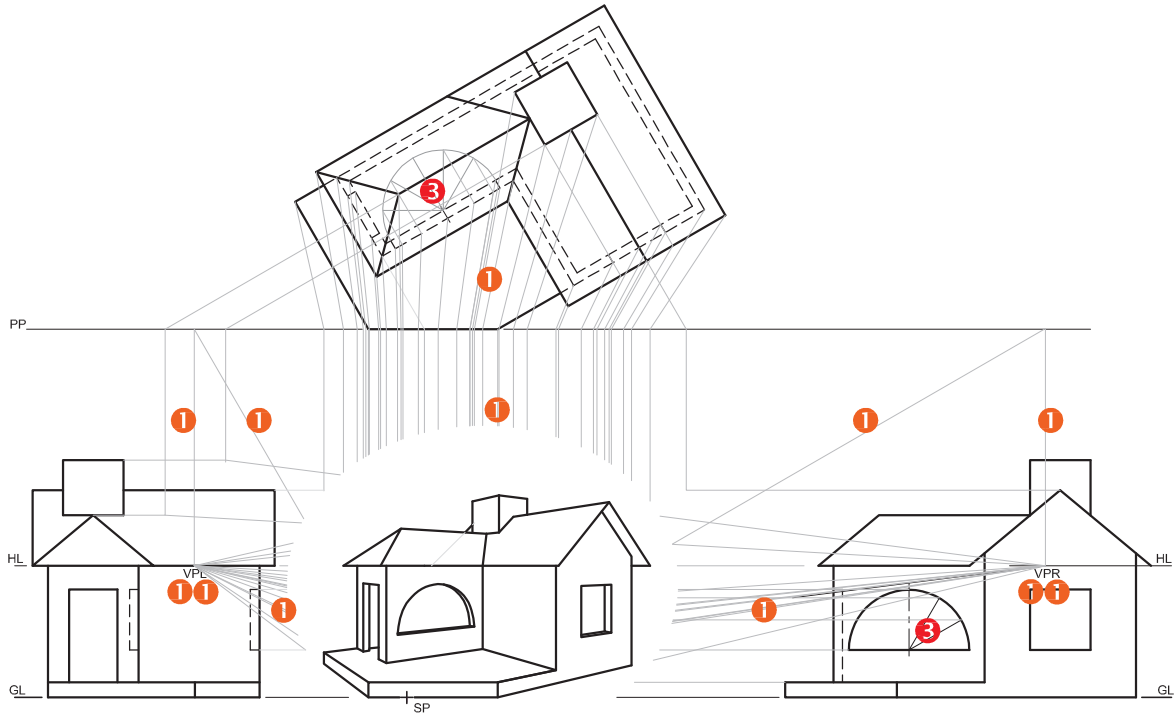

3 ✓ KURWE KWALITEIT

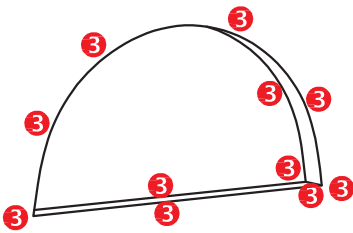

BESONDERHEDE VAN
DIE PUNTETOEKENING
VAN DIE BOOG

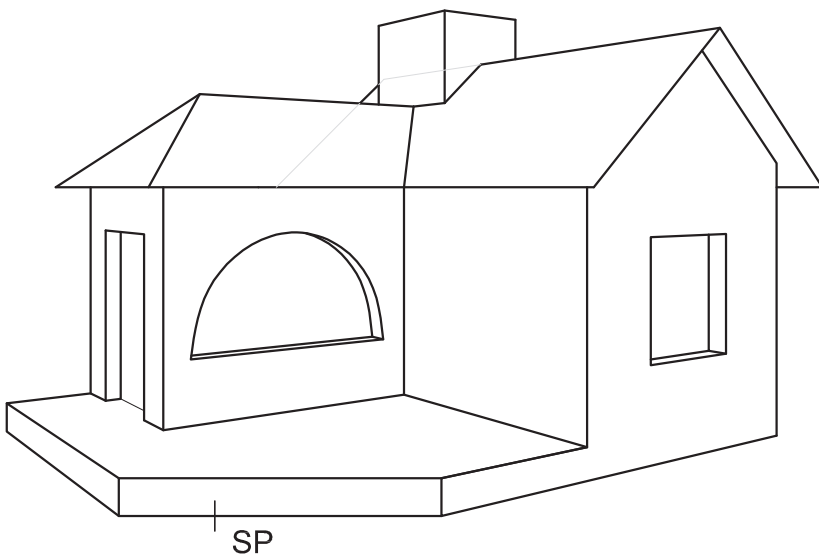
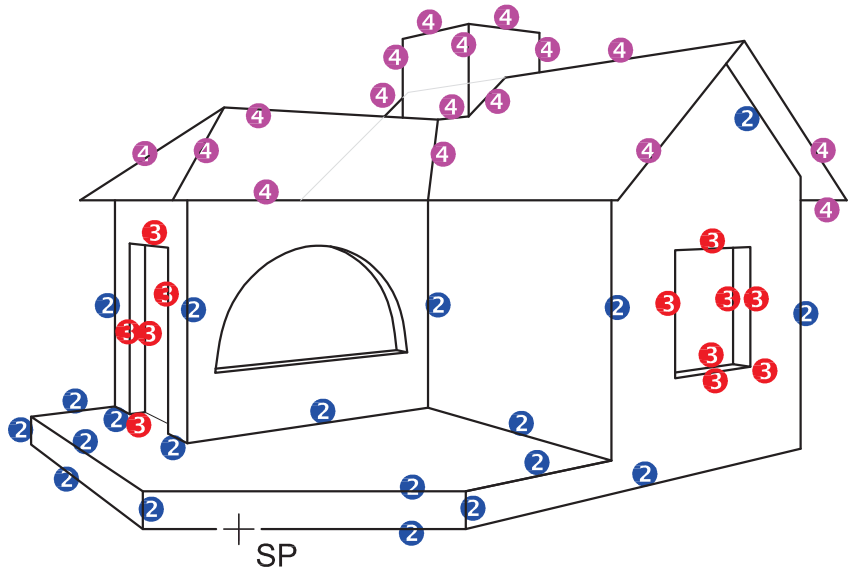

ASSESSERINGSKRITERIA

1	KONSTRUKSIE	6
2	VLOER EN MURE	10
3	DEUR EN VENSTERS	13 $\frac{1}{2}$
4	DAK	8 $\frac{1}{2}$
TOTAAL		38

GOEDGEKEUR

VRAESTEL 1 VRAAG 3
GRAAD 12
SS/NSS 2019
NASIENRIGLYNE

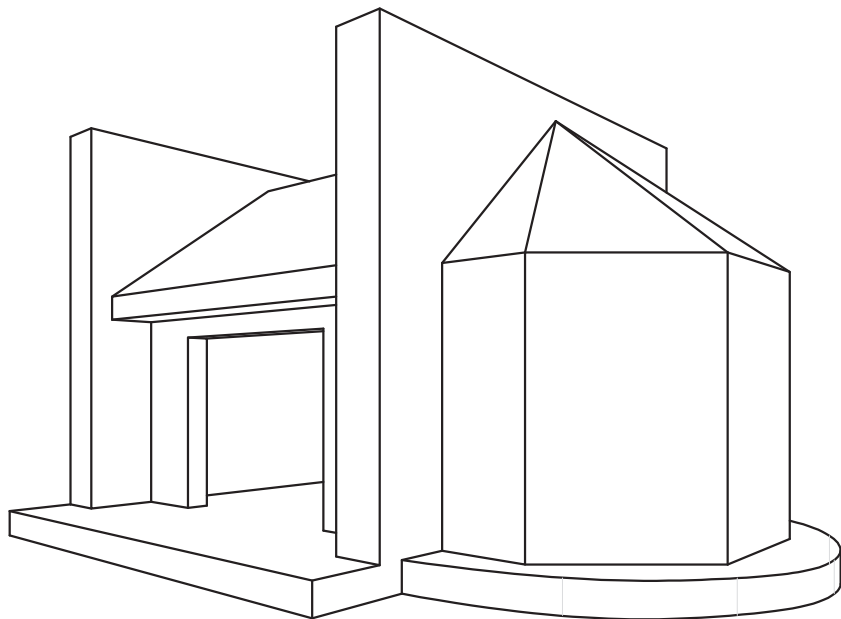
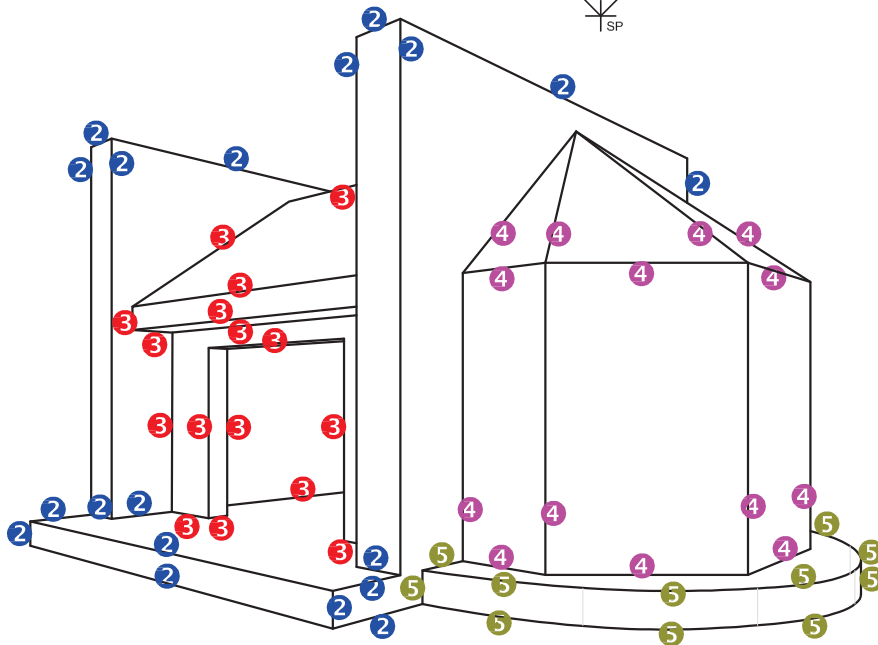
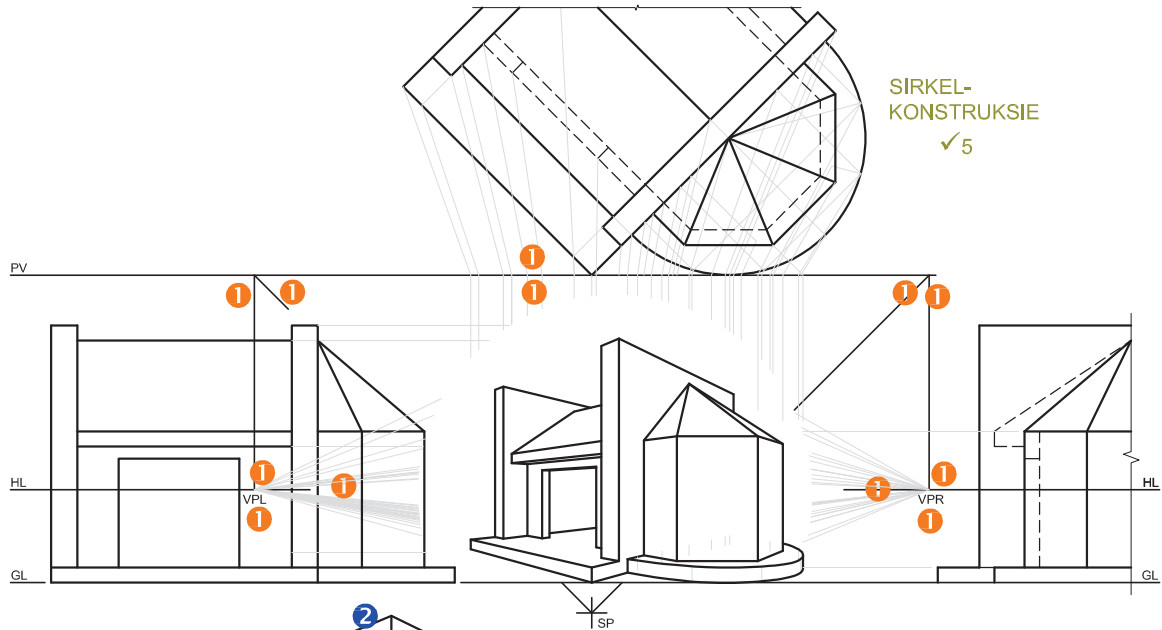

ASSESSERINGSKRITERIA		
1	KONSTRUKSIE	6
2	BUITESTRUKTUUR	9 ¹ / ₂
3	BINNESTRUUKTUUR	8
4	KANTSTRUUKTUUR	7
5	BOË	6 ¹ / ₂
PENALISERING (-)		
TOTAAL		37

SP

VRAESTEL 1 VRAAG 3
 GRAAD 12
 NOVEMBER 2018
 NASIENRIGLYN

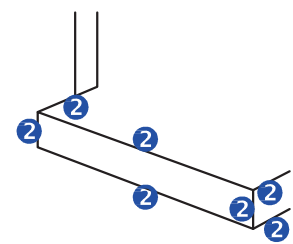
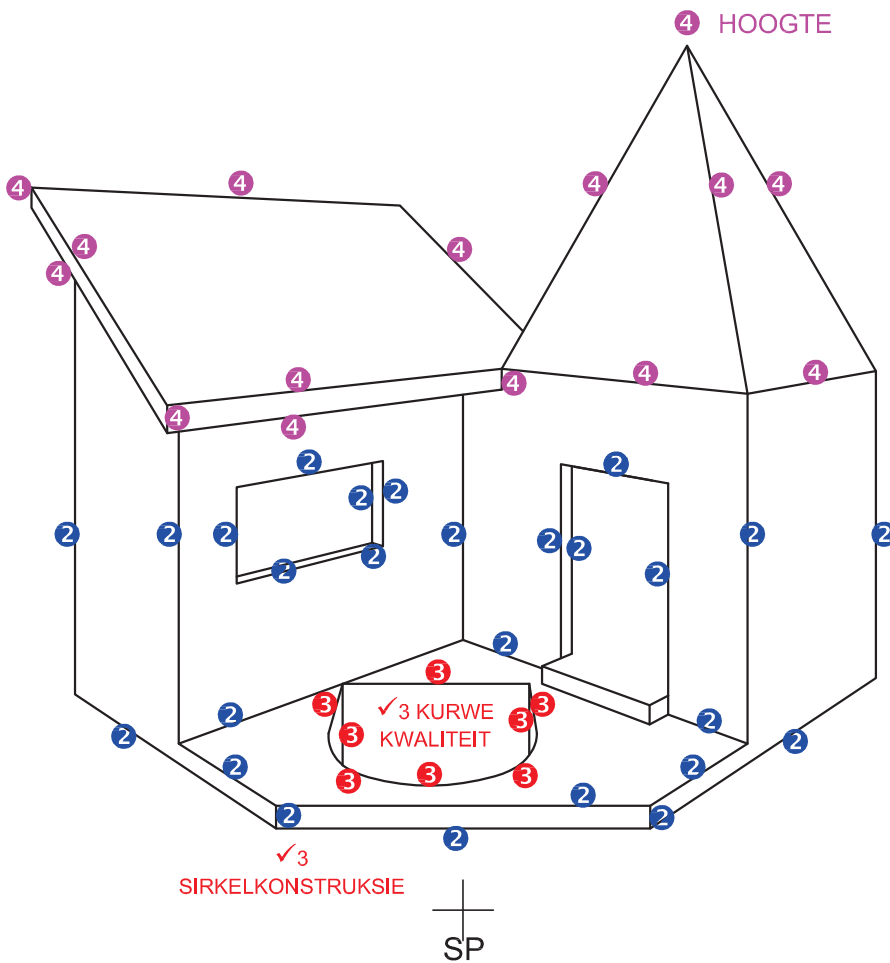
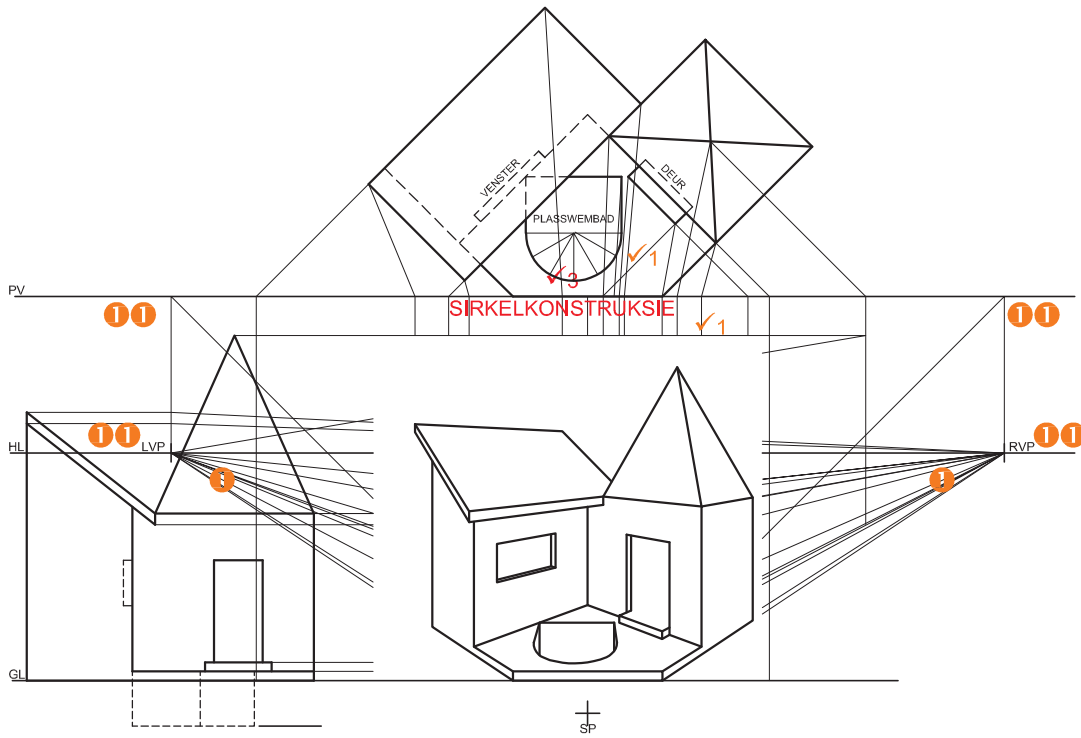

BESONDERHEDE VAN DIE PUNTETOEKENNING VAN DIE DEURTRAP

ASSESSERINGSKRITERIA		
1	KONSTRUKSIES	7
2	MURE, VENSTER, DEUR	16 $\frac{1}{2}$
3	PLASSWEMBAD	7
4	DAK	7 $\frac{1}{2}$
TOTAAL		38

VRAESTEL 1 VRAAG 3
 GRAAD 12
 SSE 2018
 NASIENRIGLYNE

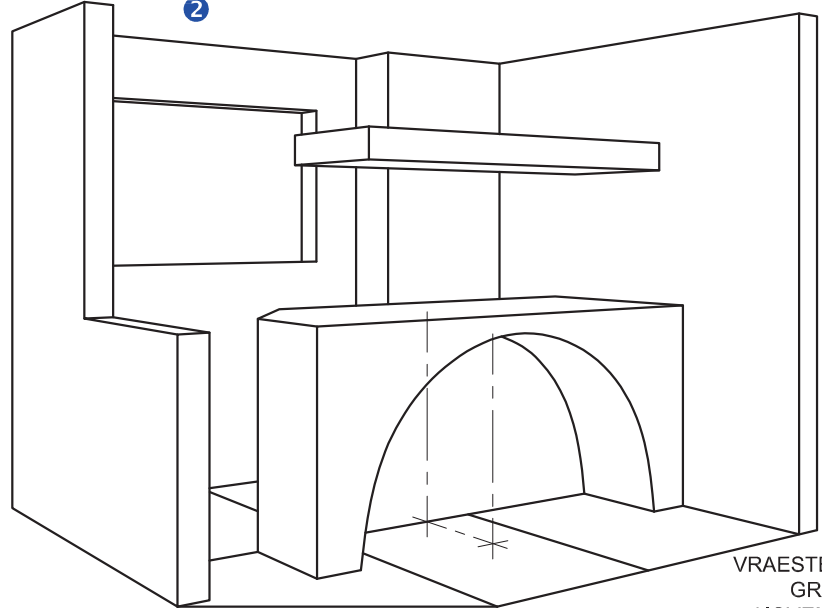
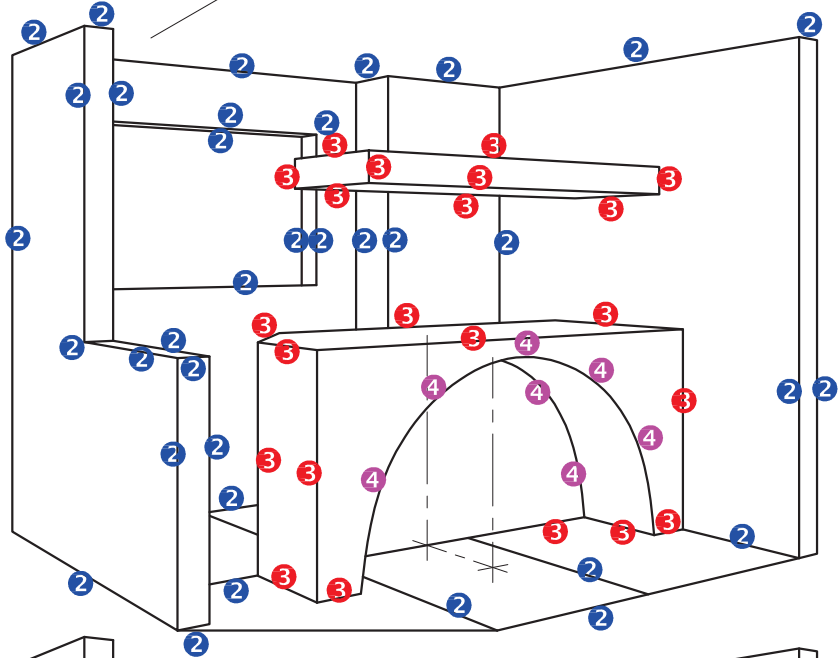
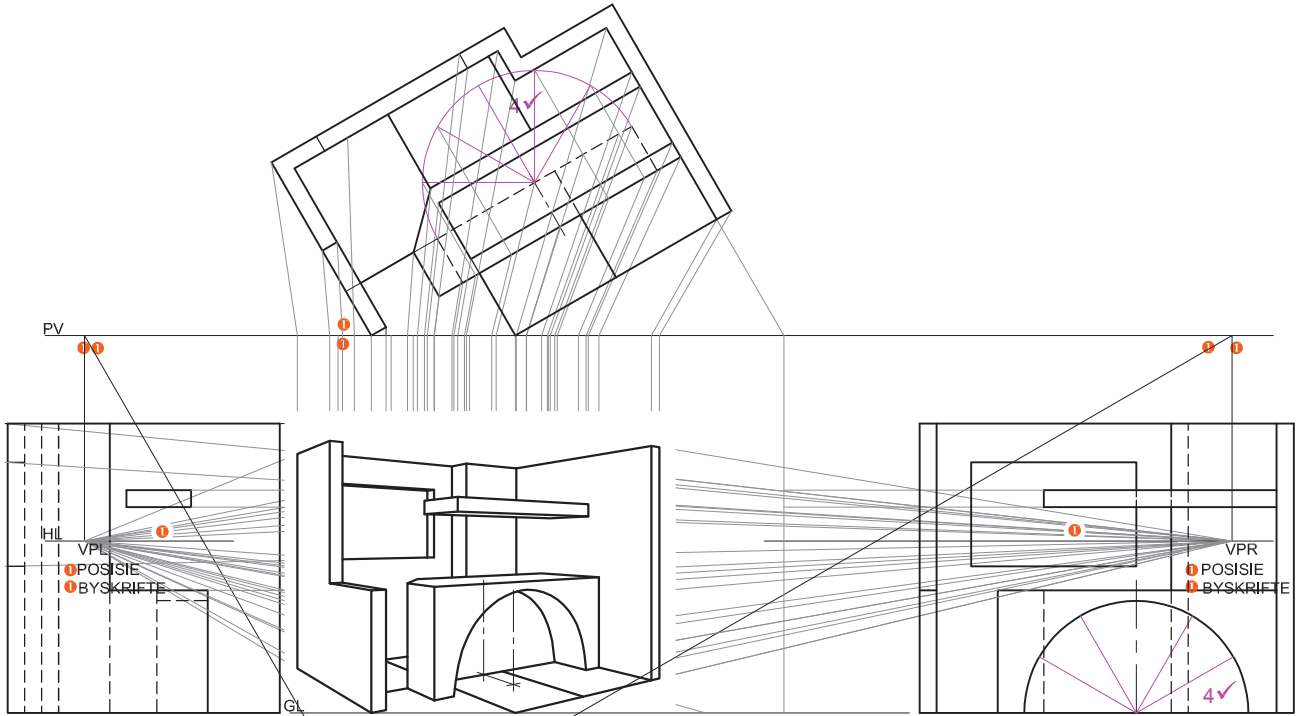

ASSESSERINGSKRITERIA		
1	KONSTRUKSIES	6
2	MURE EN VENSTER	17½
3	BEDIENINGSAREA	11
4	HALFSIRKEL	5½
PENALISERING (-)		
TOTAAL		40

VRAESTEL 1 VRAAG 3
 GRAAD 12
 NOVEMBER 2017
 NASIENRIGLYNE

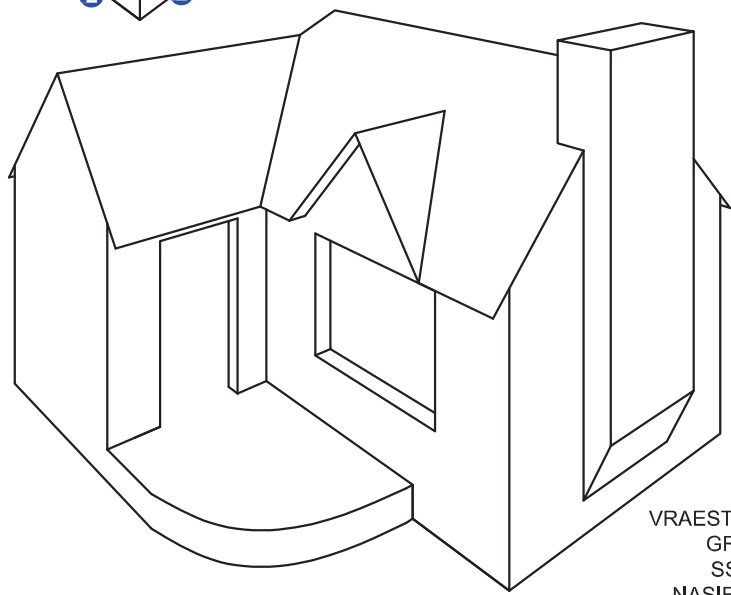
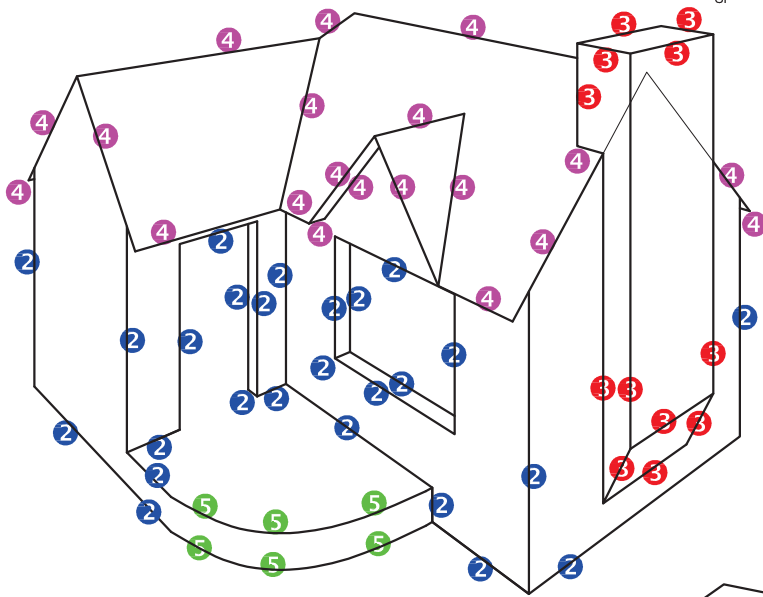
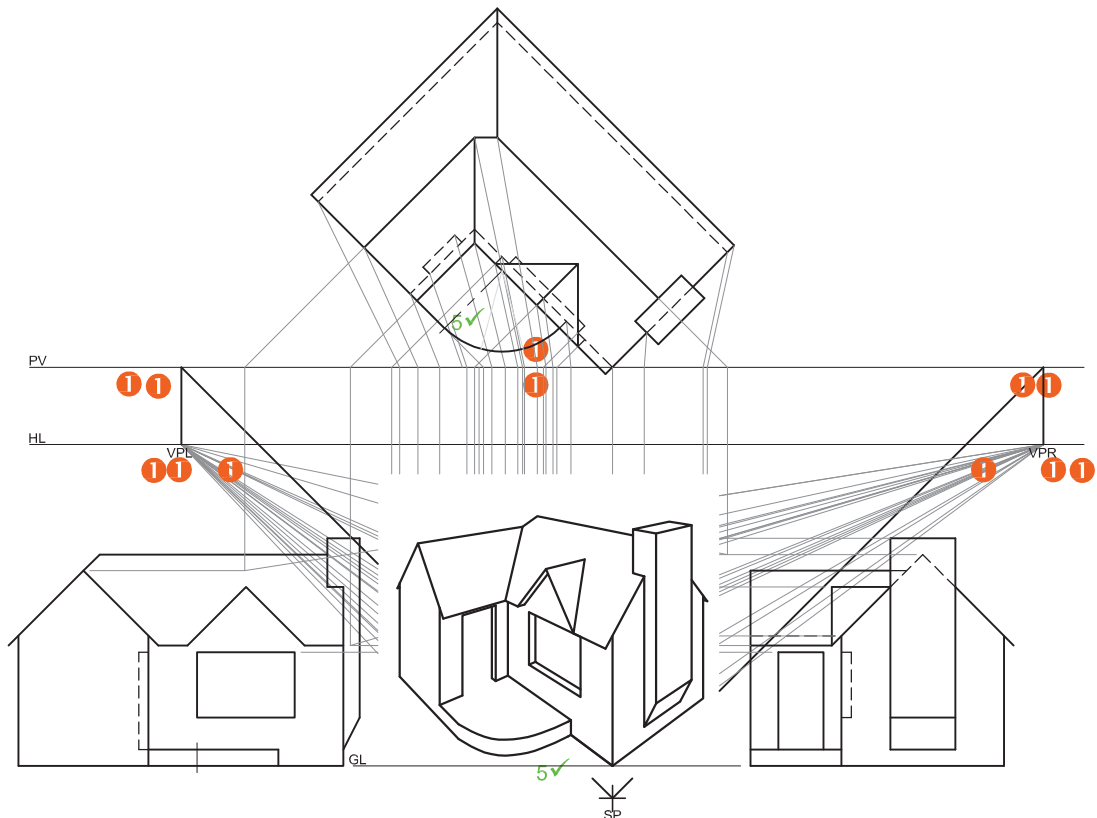

ASSESSERINGSKRITERIA		
1	KONSTRUKSIE	6
2	MURE, VENSTER, DEUR	13
3	SKOORSTEEN	6
4	DAK	10
5	BOOG	5
TOTAAL		40

VRAESTEL 1 VRAAG 3
 GRAAD 12
 SSE 2017
 NASIENRIGLYNE

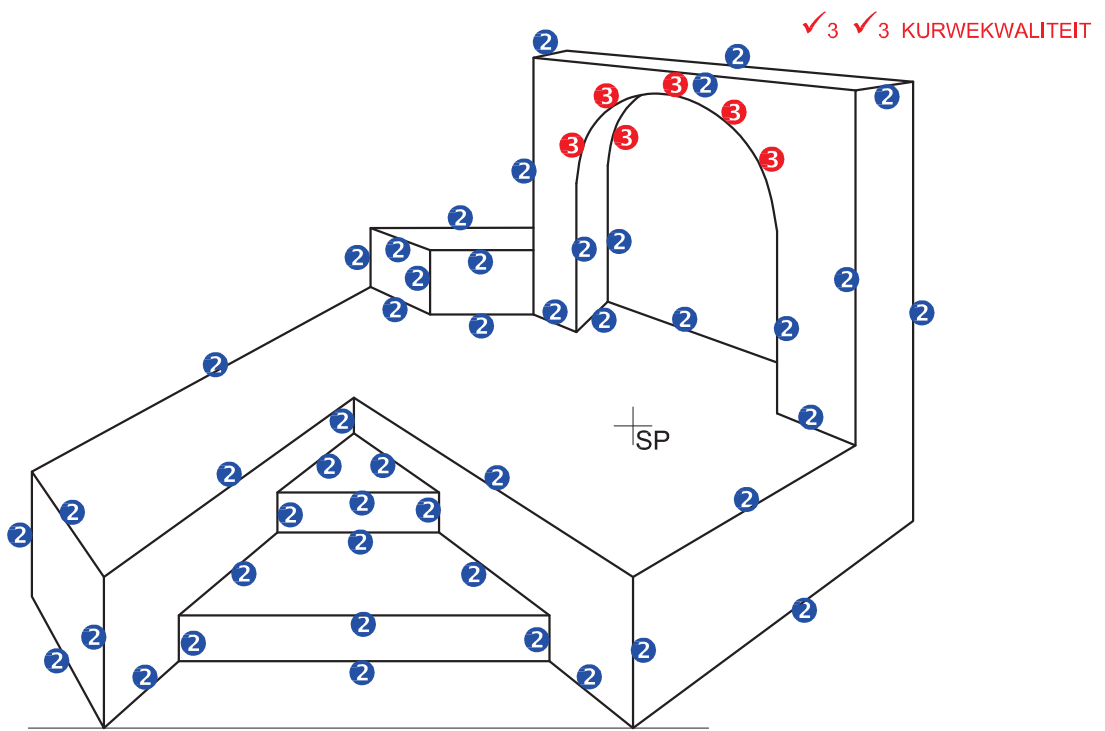
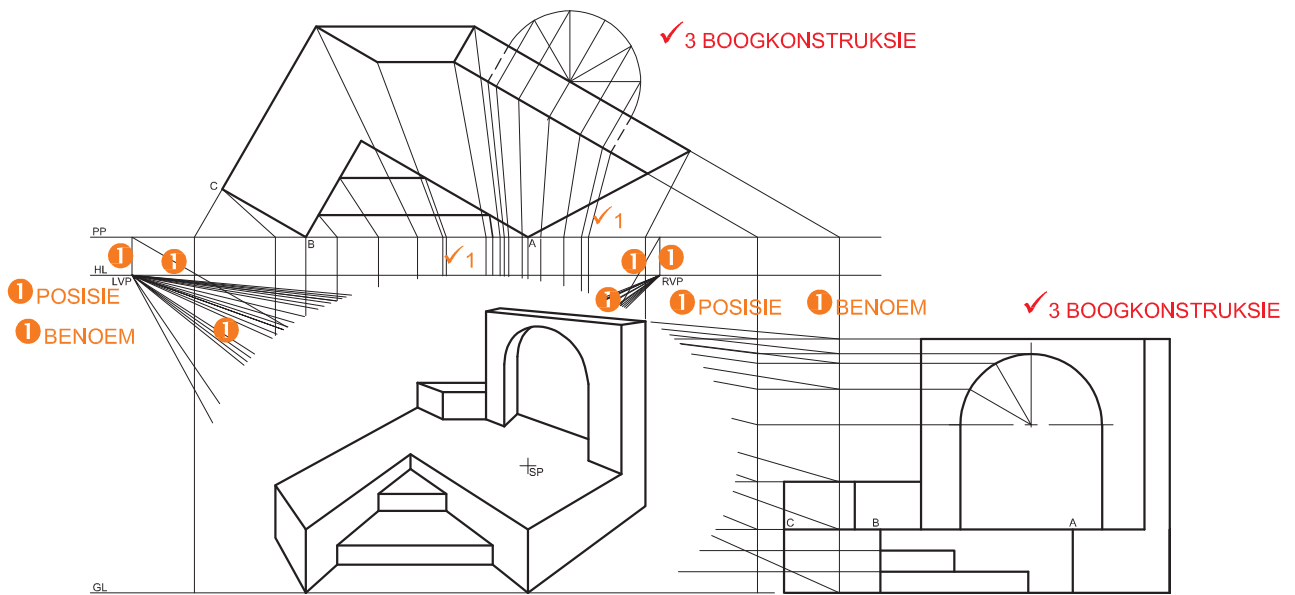

VRAESTEL 1 VRAAG 3
 GRAAD 12
 Feb.-Mrt. 2017
 MEMORANDUM

ASSESSERINGSKRITERIA		
1	KONSTRUKSIES + VP'e	7
2	TRAPPE + VLOER + MURE	23
3	SIRKELBOOG	7
TOTAAL		37

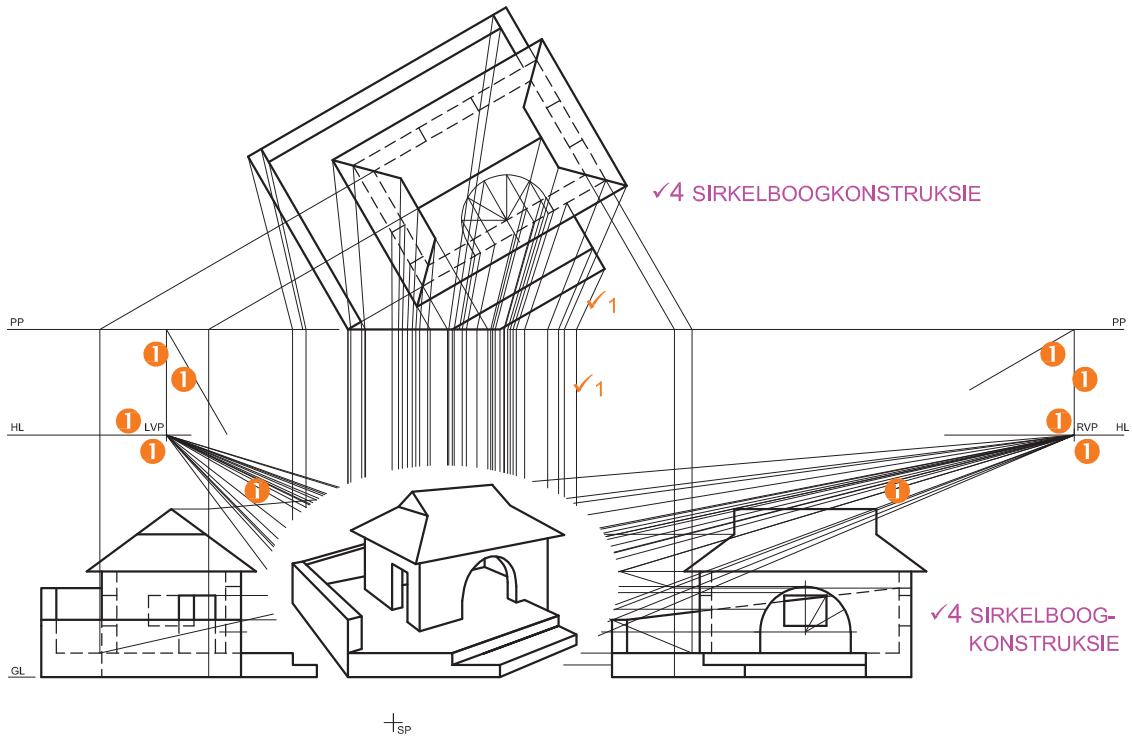

✓4 KURWEKWALITEIT

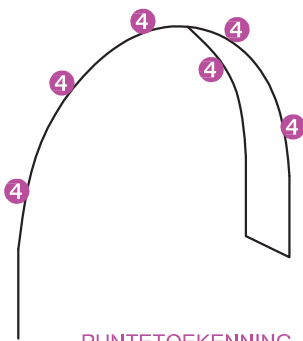

PUNTTOEKENING
VIR DIE SIRKELBOOG

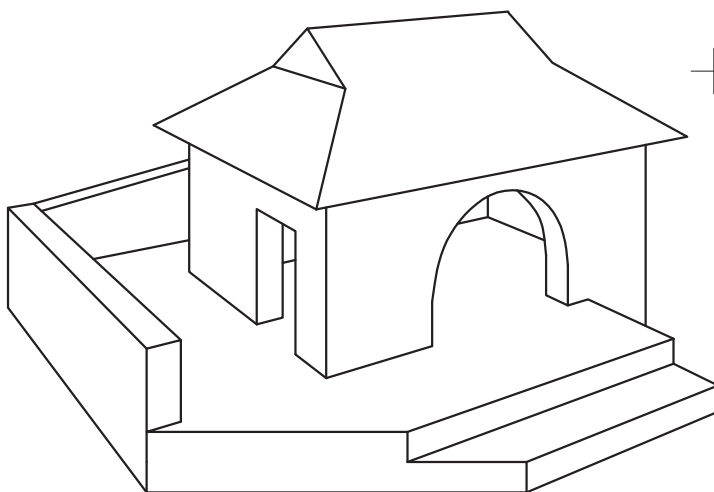
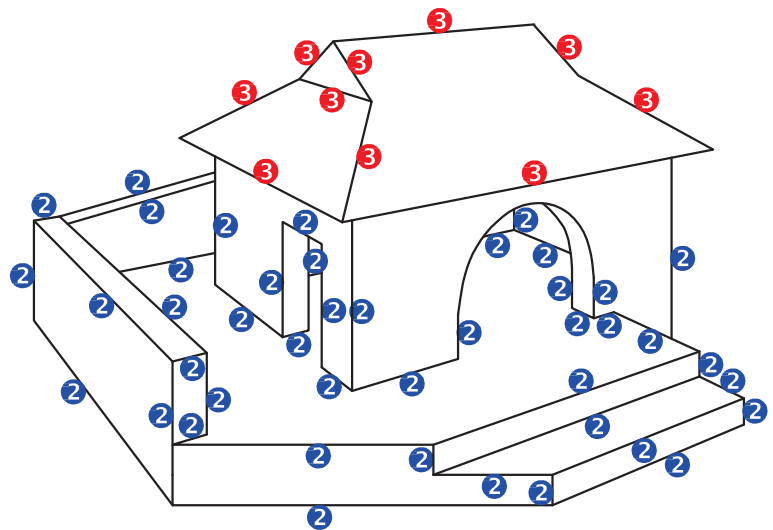

SP

SP

VRAESTEL 1 VRAAG 3
GRAAD 12
NOVEMBER 2016
MEMORANDUM

ASSESSERINGSKRITERIA		
1	KONSTRUKSIES + VP'e	7
2	MURE + DEURE	22
3	DAK	5
4	SIRKELBOOG	6
TOTAAL		40

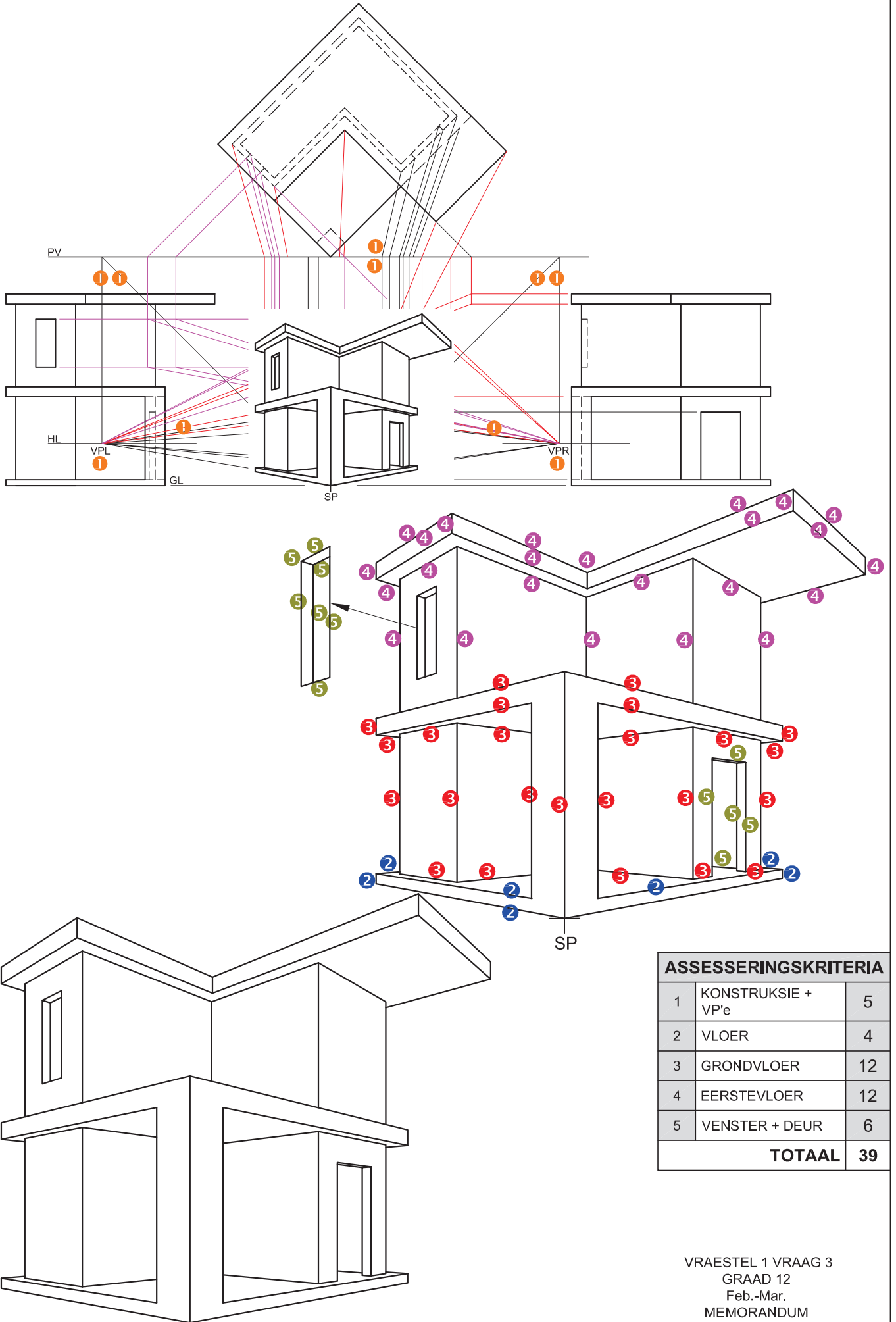

ASSESSERINGSKRITERIA		
1	KONSTRUKSIE + VP'e	5
2	VLOER	4
3	GRONDVLOER	12
4	EERSTEVLOER	12
5	VENSTER + DEUR	6
TOTAAL		39

VRAESTEL 1 VRAAG 3
 GRAAD 12
 Feb.-Mar.
 MEMORANDUM

ASSESSERINGSKRITERIA

1	KONSTRUKSIES + VP's	6
2	BASIS + TRAPPE	12½
3	SWEMBAD	13½
4	SIRKELBOOG	7
TOTAAL		39

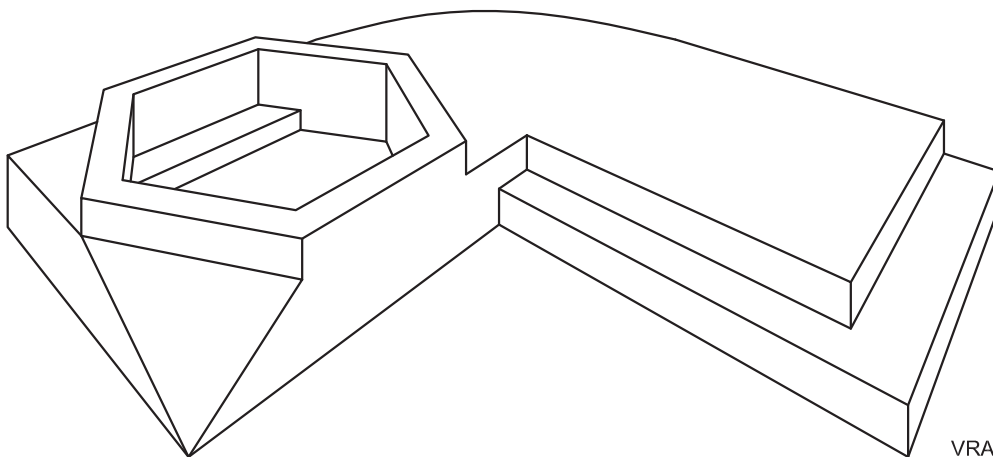
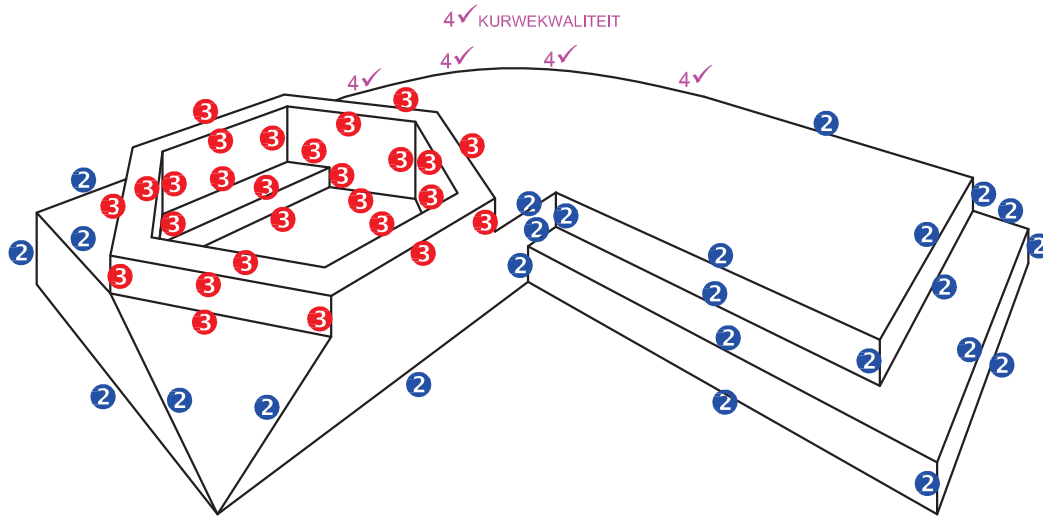
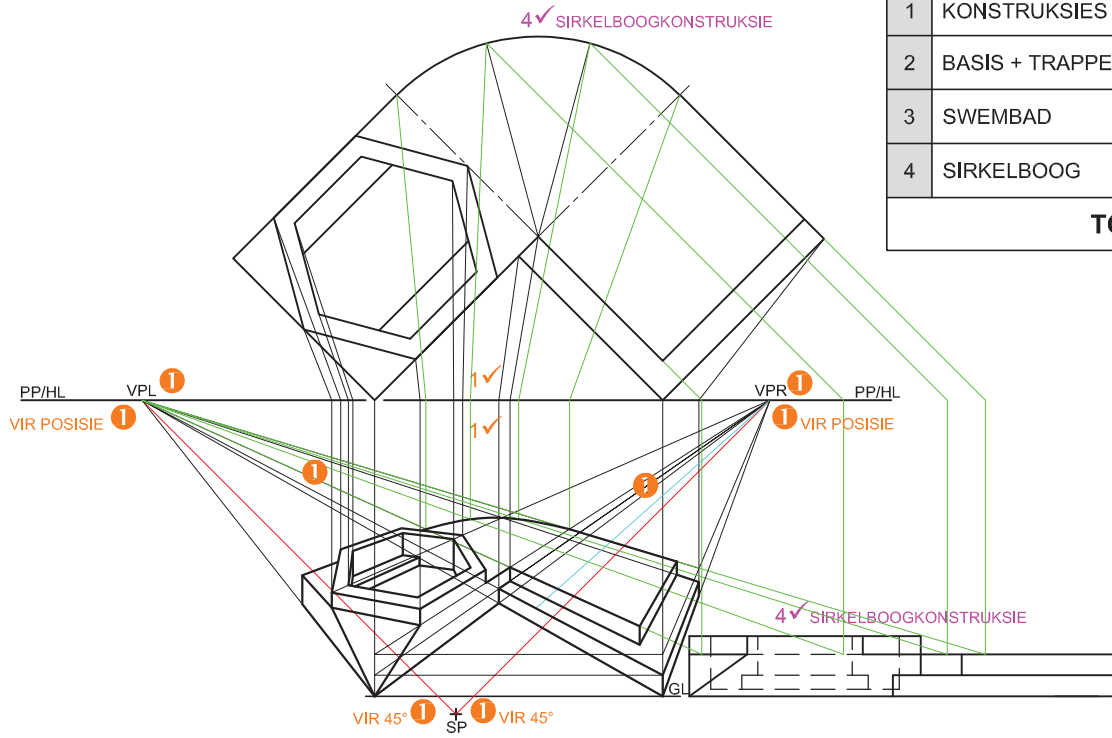

SP

VRAESTEL 1 VRAAG 3
 GRAAD 12
 November 2015
 MEMORANDUM

ASSESSERINGSKRITERIA		
1	KONSTRUKSIE + VP's	7
2	DAK	4
3	MURE	17
4	KWARTSIRKEL	6
5	VENSTER + DEUR	6
TOTAAL		40

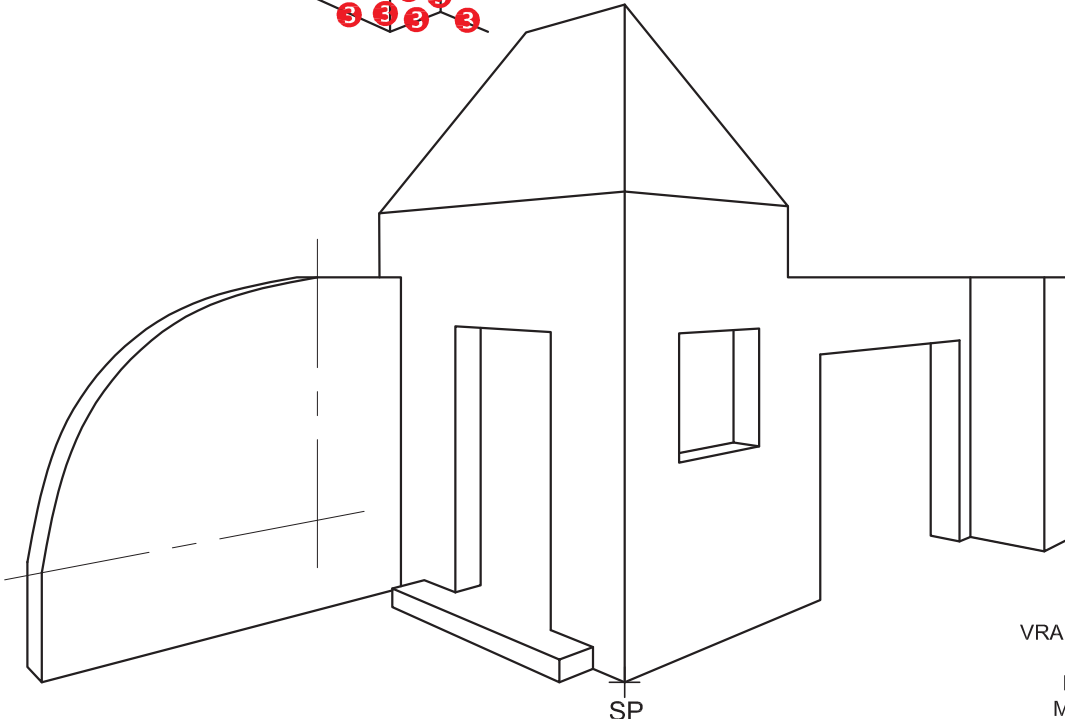
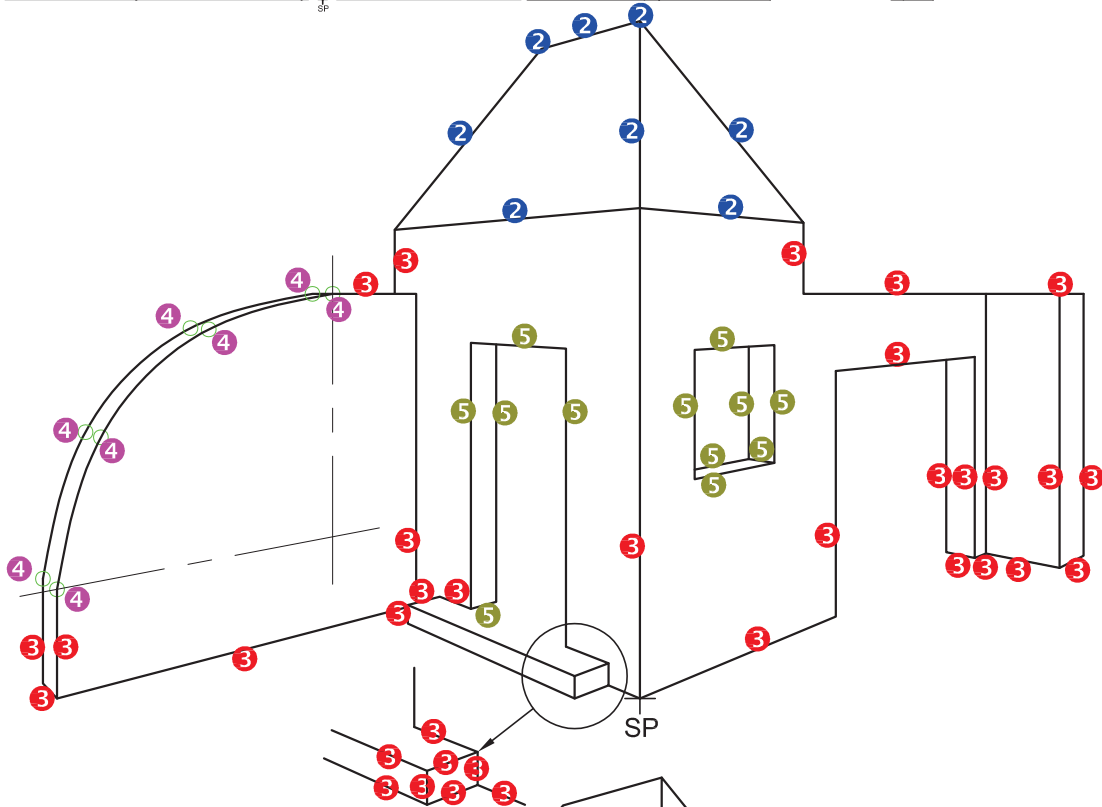
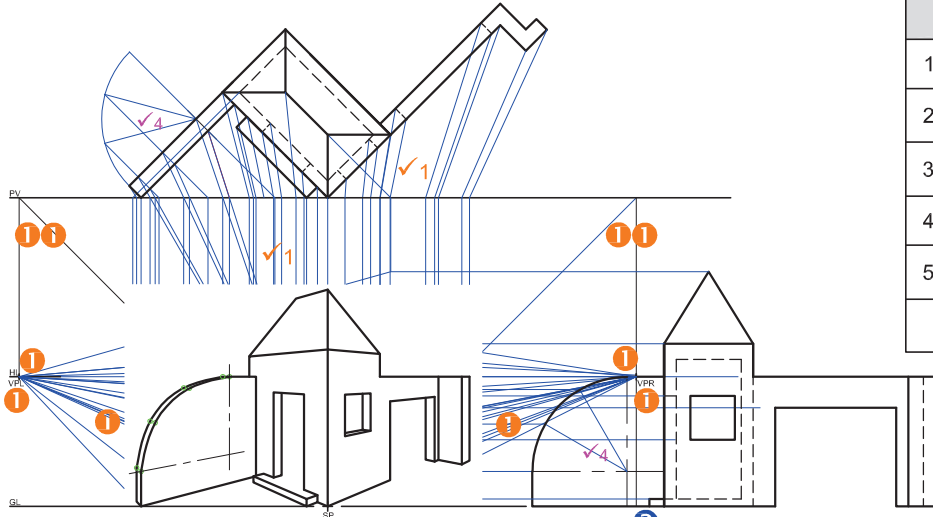

VRAESTEL 1 VRAAG 3
 GRAAD 12
 Feb.-Mrt. 2015
 MEMORANDUM

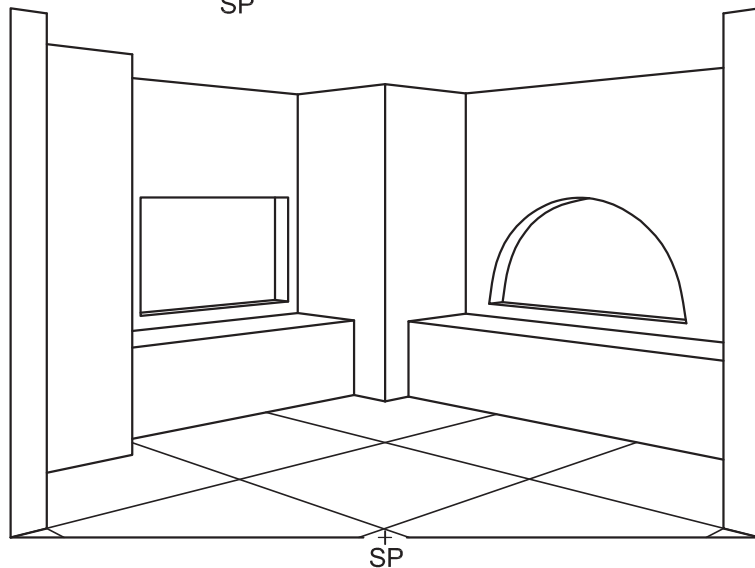
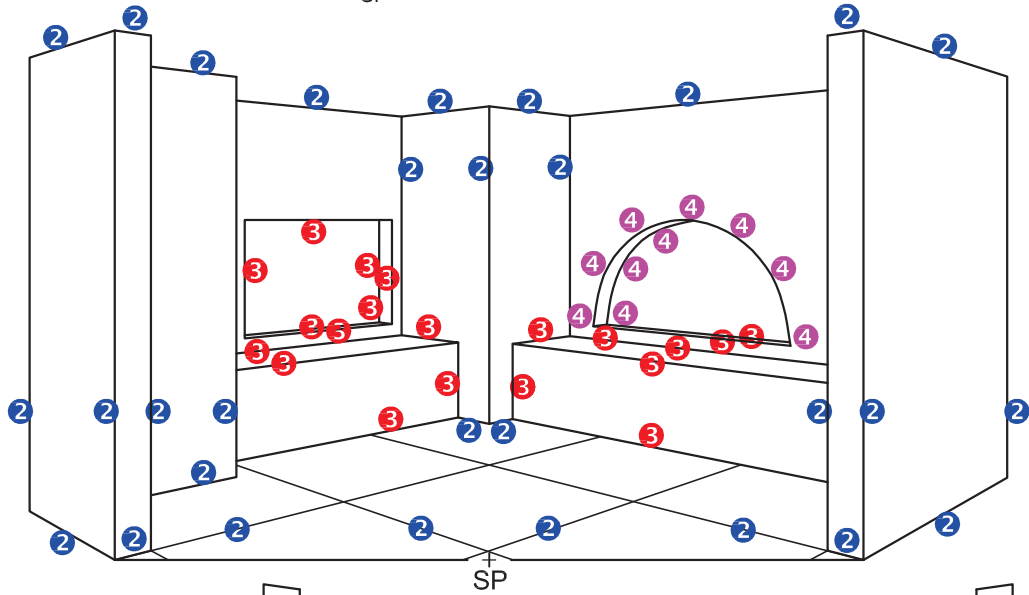
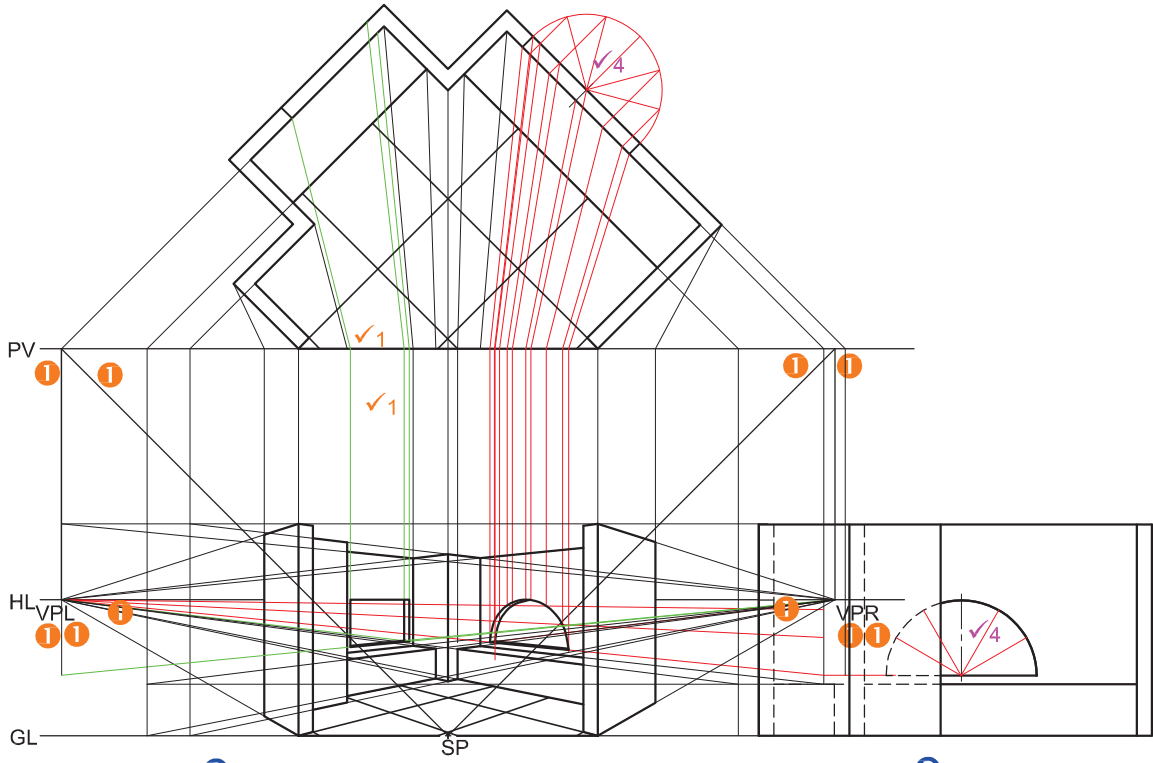

ASSESSERINGSKRITERIA		
1	KONSTRUKSIE + VPs	7
2	MURE + TEËLS	15
3	OPENINGE + SITPLEKKE	10
4	HALFSIRKEL	7
TOTAAL		39

VRAESTEL 1 VRAAG 3
 GRAAD 12
 NOVEMBER 2014
 MEMORANDUM

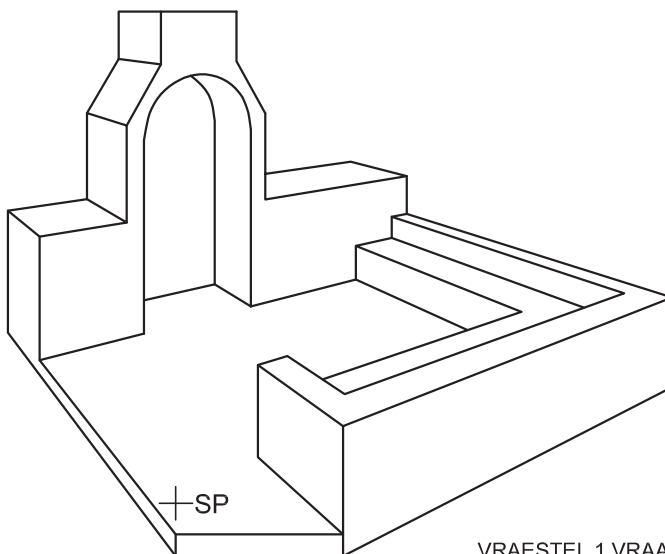
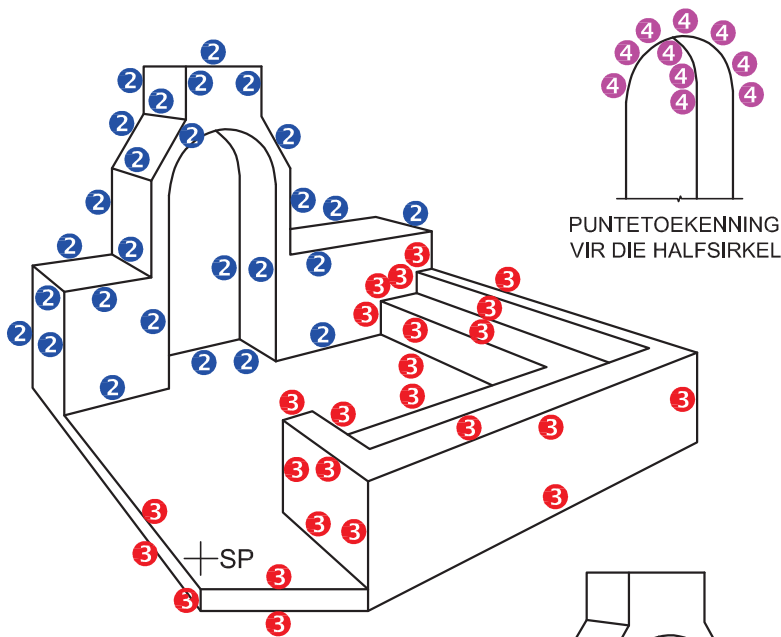
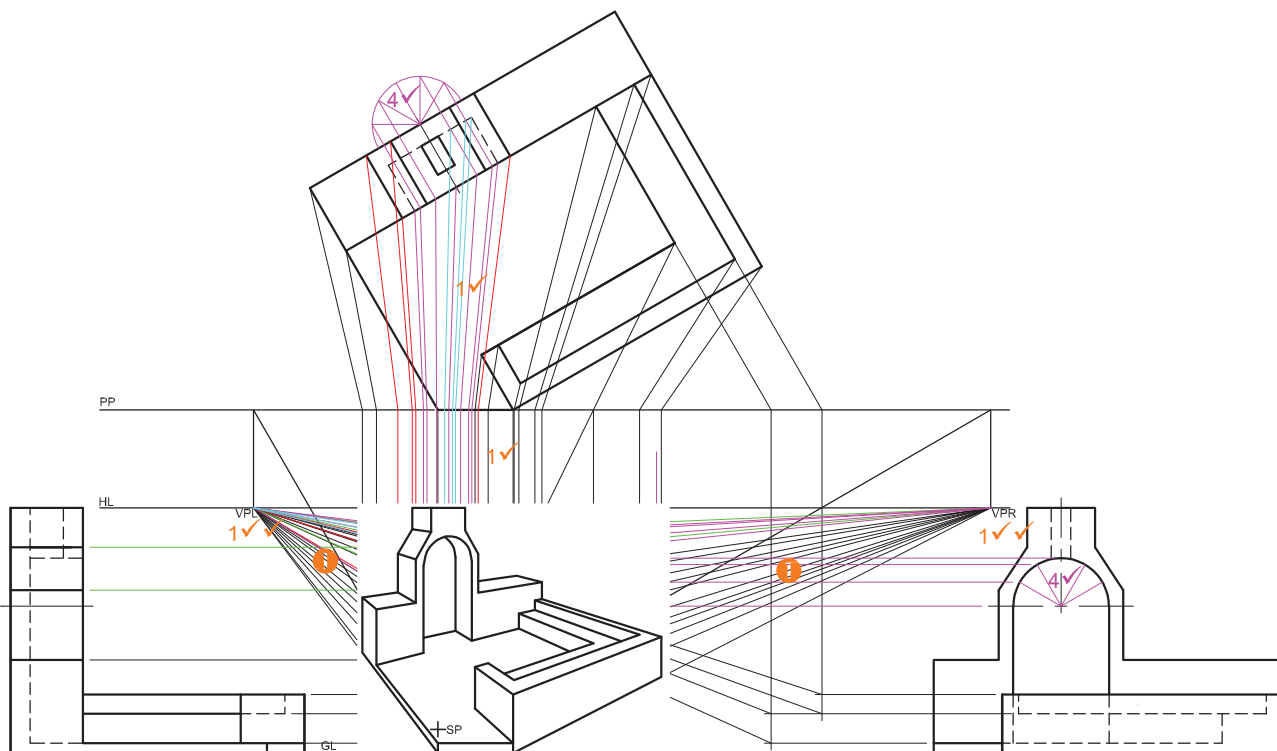

ASSESSERINGSKRITERIA		
1	KONSTRUKSIE + VP'e	7
2	BRAAI	14½
3	SITPLEKKE	13
4	HALFSIRKEL	5½
TOTAAL		40

VRAESTEL 1 VRAAG 3
 GRAAD 12
 EXEMPLAR 2014
 MEMORANDUM

The drawing illustrates a kitchen interior with a perspective view at the top and an orthographic view below. The perspective view shows a window (VENSTER), a washing machine (WAS MASJIN), a sink (LVP), a stove (RVP), and a range hood. Construction lines in red and blue connect vanishing points (PV, HL, LVP, RVP) and a station point (SP) to various points in the scene. Assessment markers (1, 2, 3) and checkmarks (✓) are placed on the drawing to indicate the quality of construction.

The orthographic view shows the kitchen layout with assessment markers (2 and 3) placed on the walls, floor, and ceiling to evaluate the construction of lines and circles. A plus sign (+) and the label 'SP' are positioned between the two views.

ASSESSERINGSKRITERIA		
1	KONSTRUKSIES + VP'e	6
2	MURE + KASTE	17½
3	ONTTREKINGSTELSEL + SIRKELS	15½
TOTAAL		39

VRAESTEL 1 VRAAG 3
 GRAAD 12
 FEB. - MRT. 2014
 MEMORANDUM

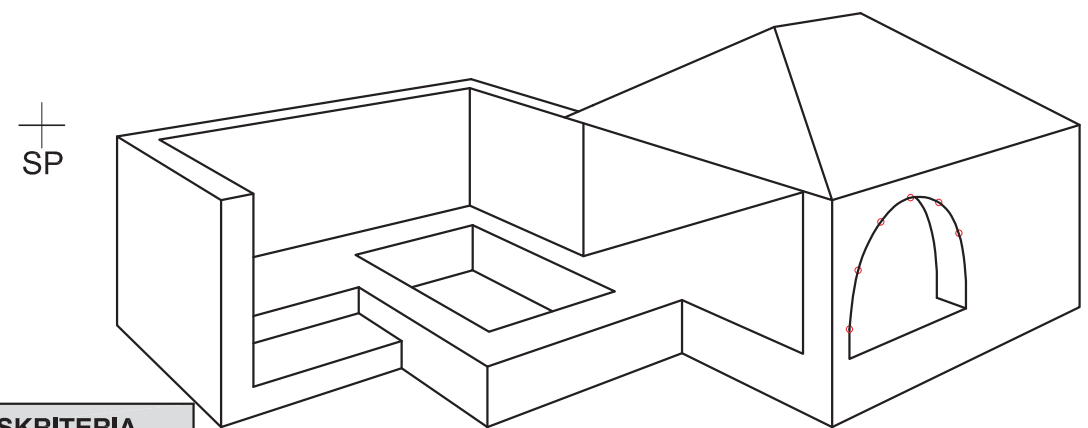
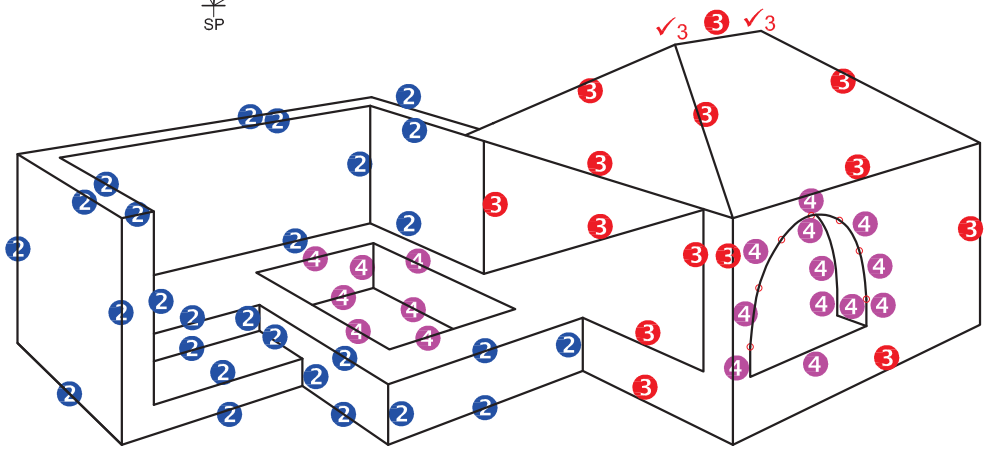
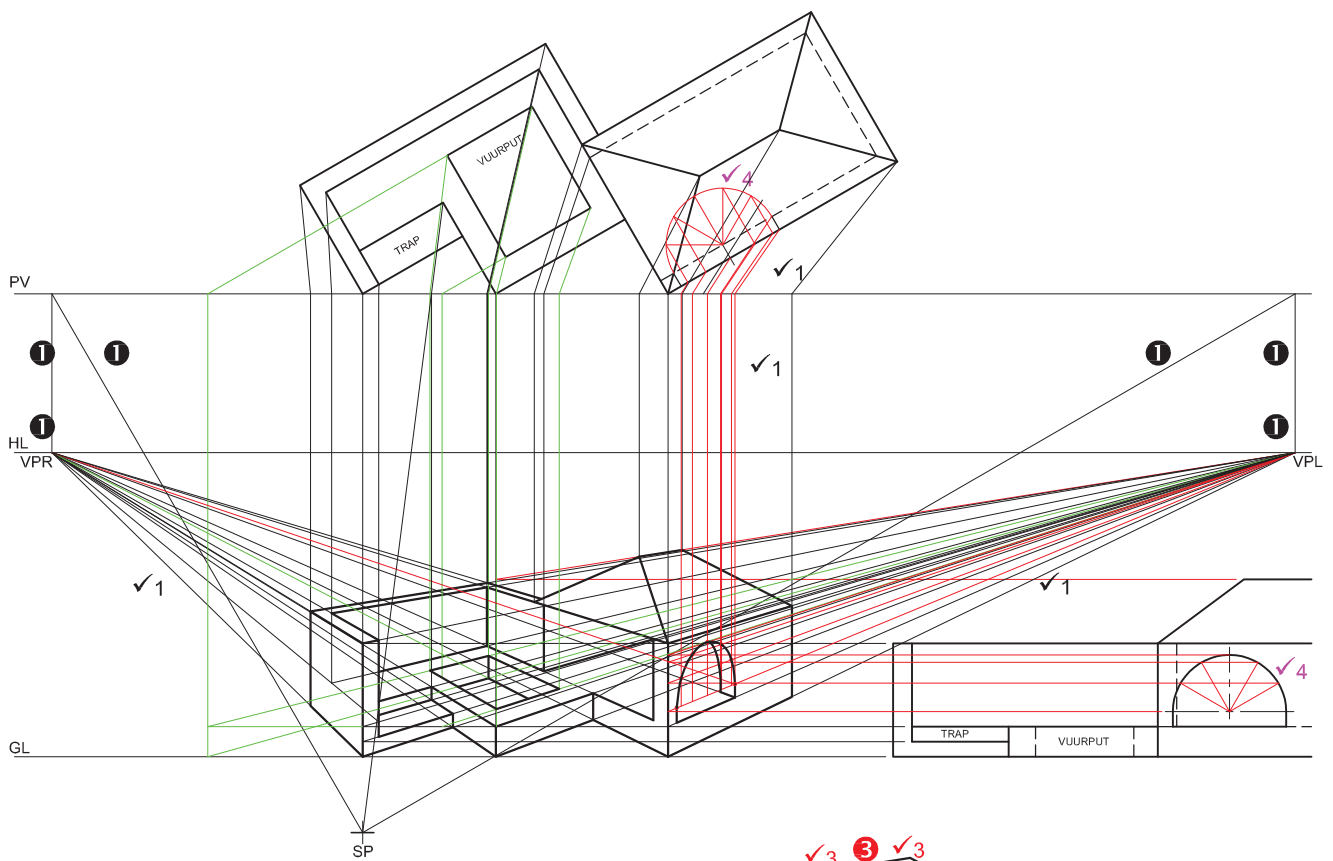

ASSESSERINGSKRITERIA		
1	KONSTRUKSIE + VP'e	7
2	MURE	13½
3	GEBOU + DAK	9
4	BOOG + KONSTR' + PUT	11½
TOTAAL		41

SP

VRAESTEL 1 VRAAG 3
 GRAAD 12
 November 2013
 MEMORANDUM

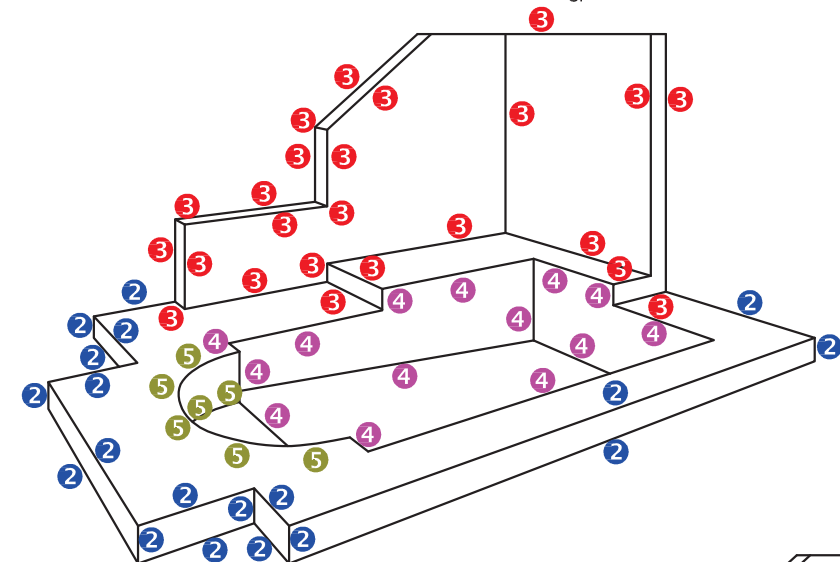
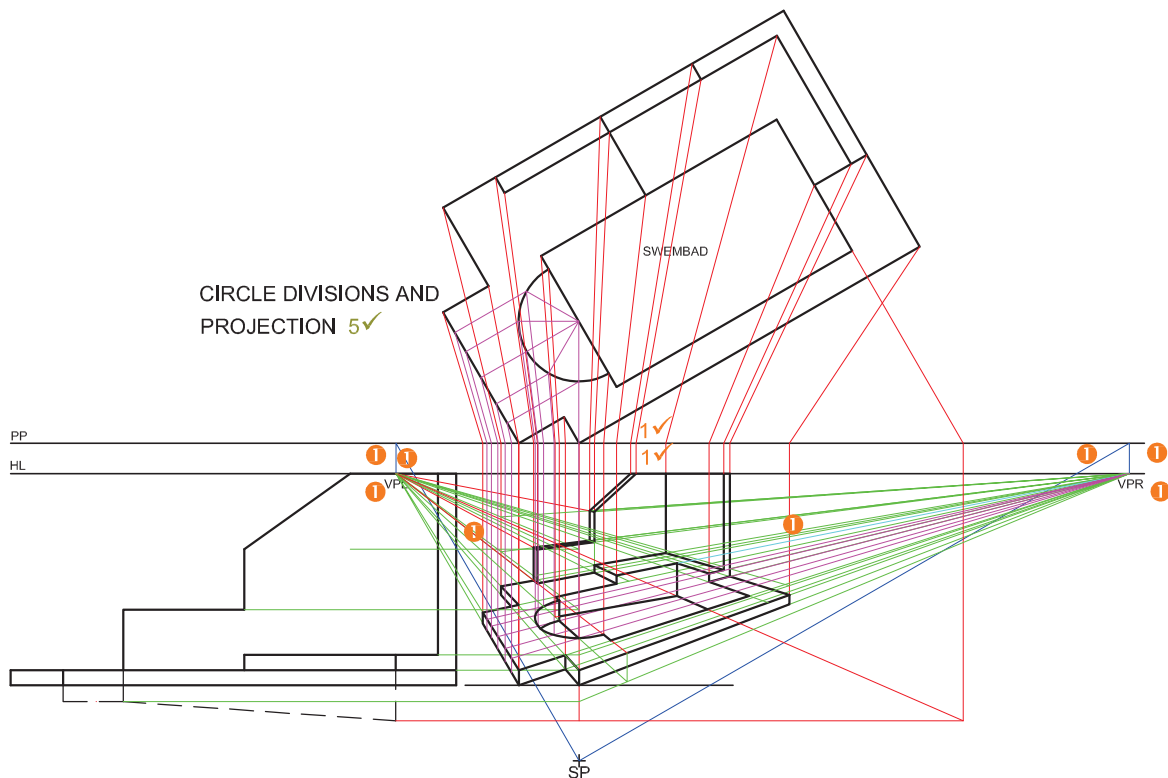

SP

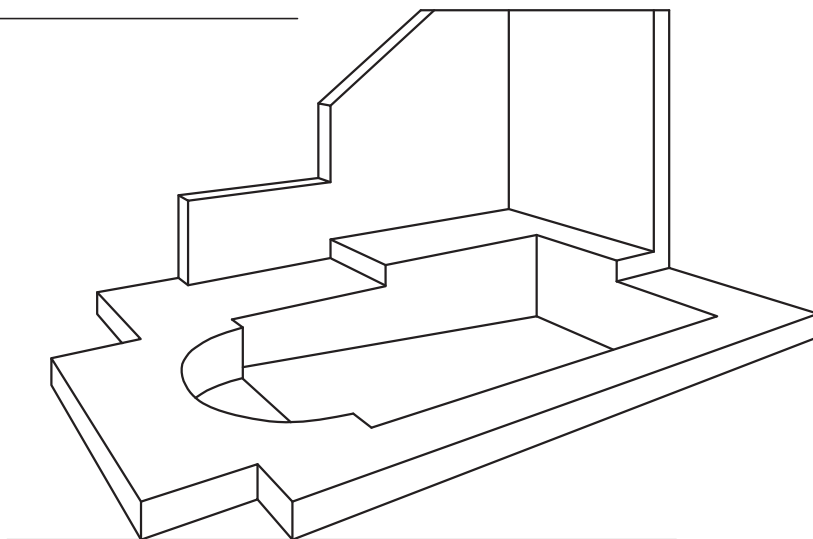

ASSESSERINGSKRITERIA		
1	KONSTRUKSIES + VP'e	6
2	OMRANDING	9½
3	MUUR + TRAP	12
4	SWEMBAD	7
5	HALF-SIRKEL	4½
TOTAAL		39

VRAESTEL 1 VRAAG 3
 GRAAD 12
 FEB. - MRT. 2013
 MEMORANDUM

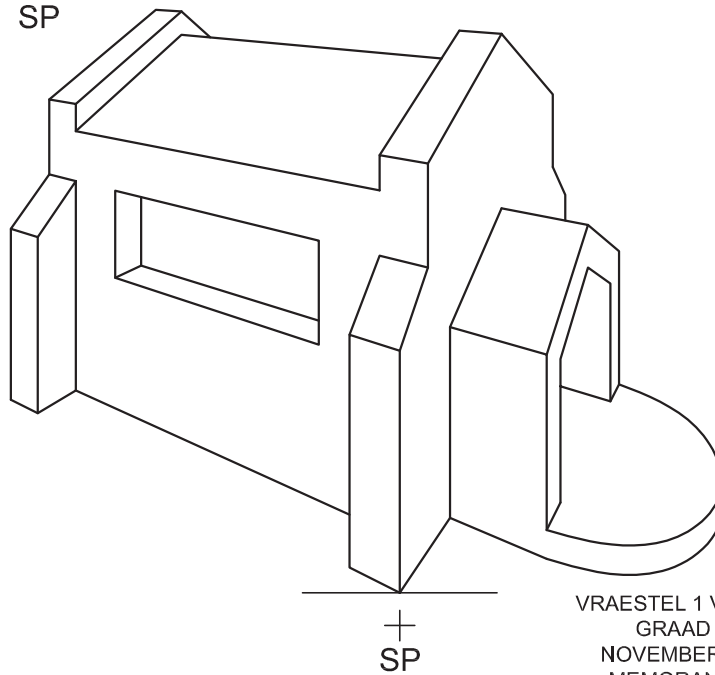
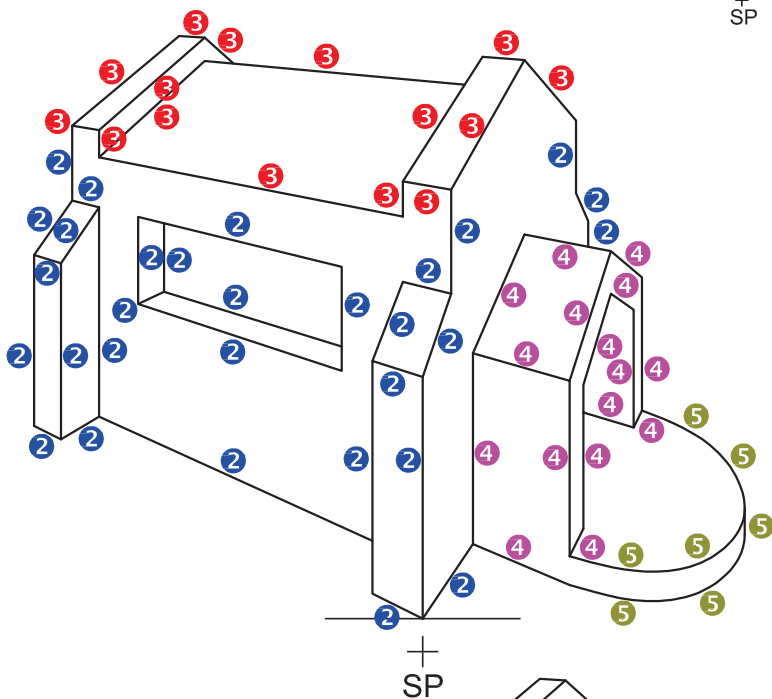
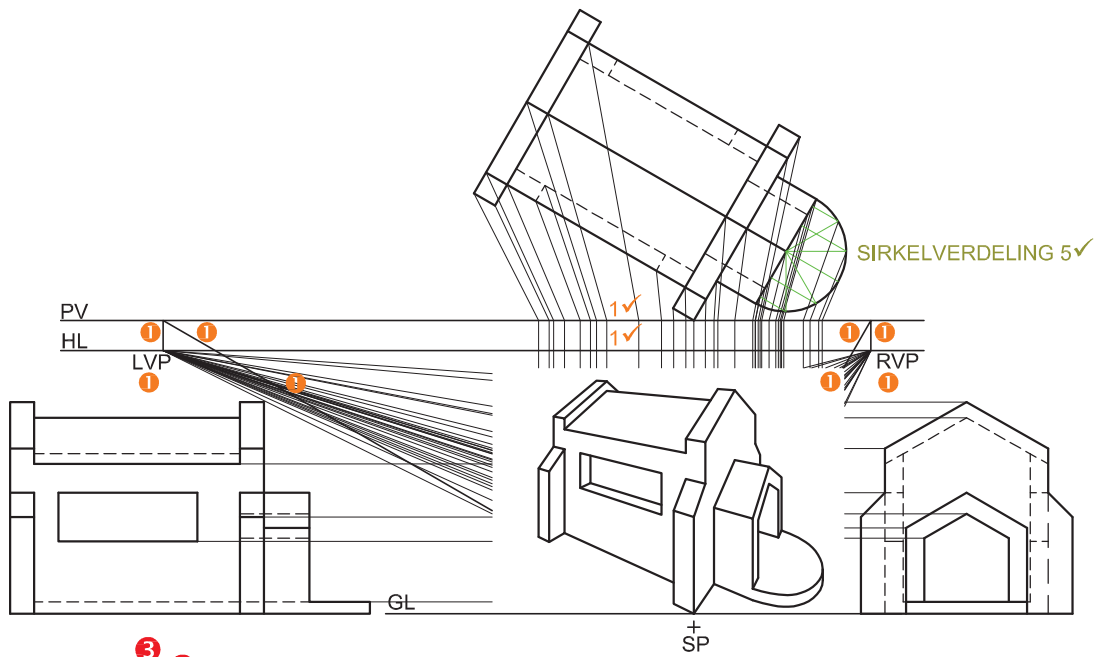

ASSESSERINGSKRITERIA		
1	KONSTRUKSIES + VP'e	6
2	GEBOU + VENSTER	15
3	DAK	7½
4	INGANG	8
5	HALFSIRKEL	4½
TOTAAL		41

VRAESTEL 1 VRAAG 3
 GRAAD 12
 NOVEMBER 2012
 MEMORANDUM

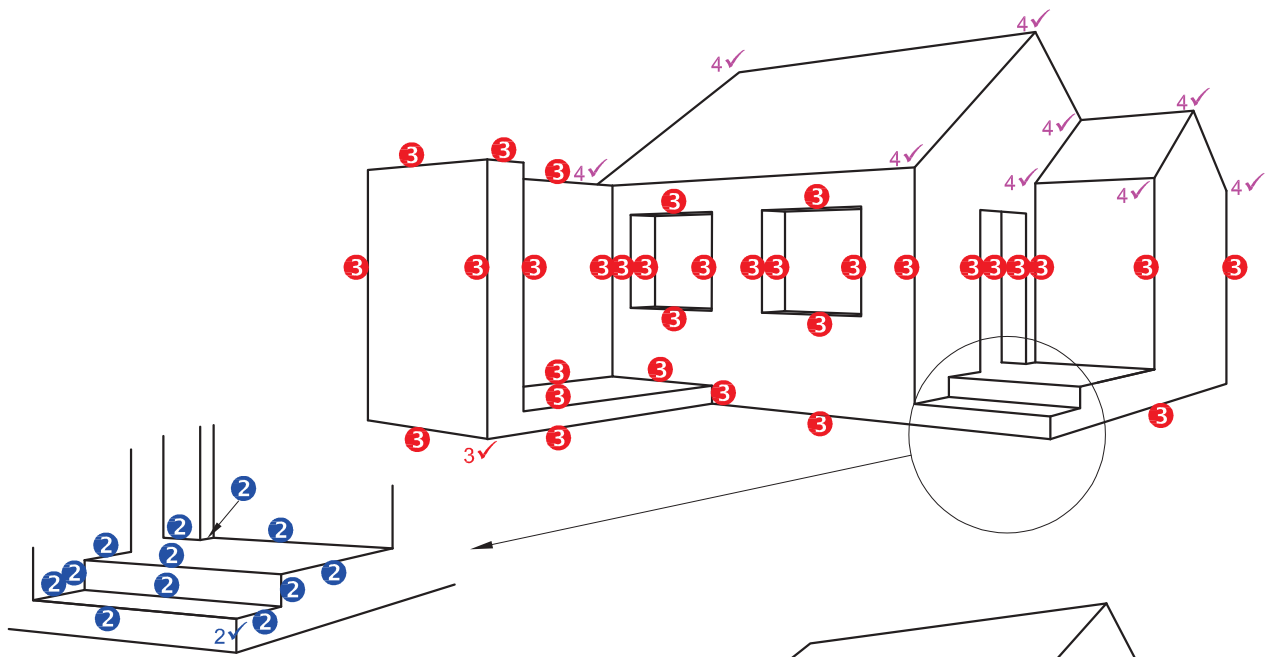
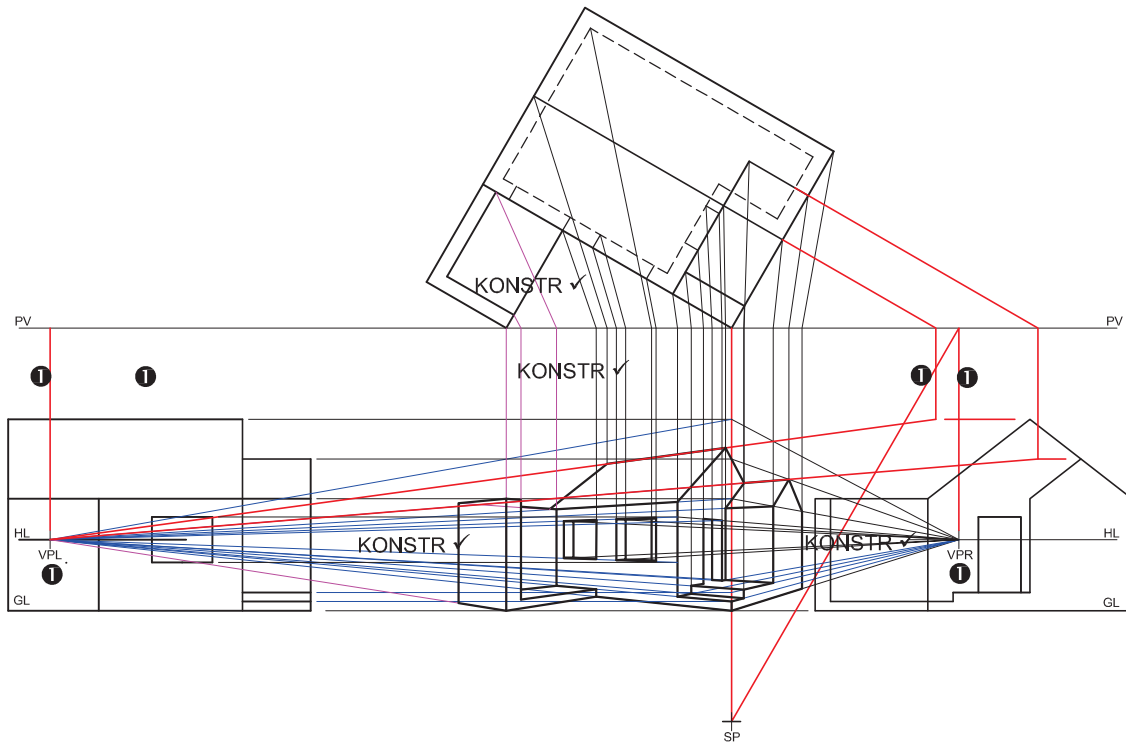

DETAIL VAN PUNTTOEKENING VIR DIE TRAPPE

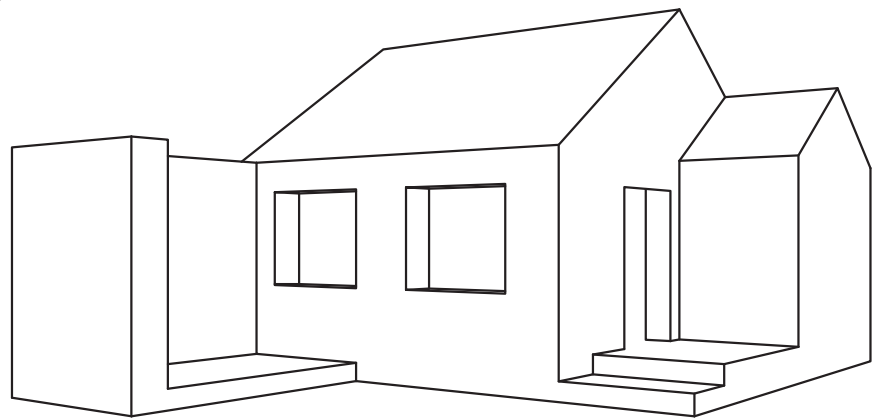

ASSESSERINGSKRITERIA	
KONSTRUKSIES + VP'e	7
TRAPPE	7
MURE + DEUR + VENSTERS	17
DAK	9
TOTAAL	40

VRAESTEL 1 VRAAG 3
 GRAAD 12
 Feb.-Mrt. 2012
 MEMORANDUM

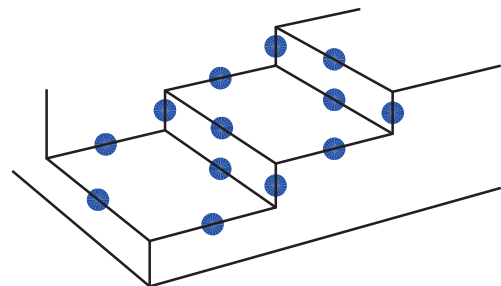
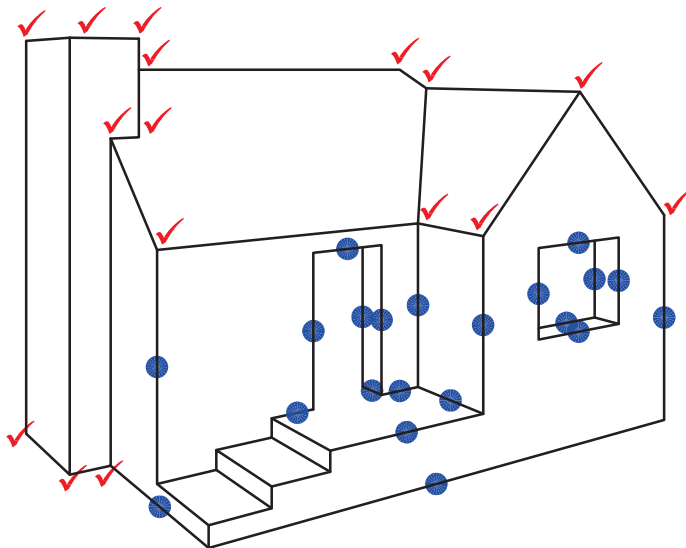
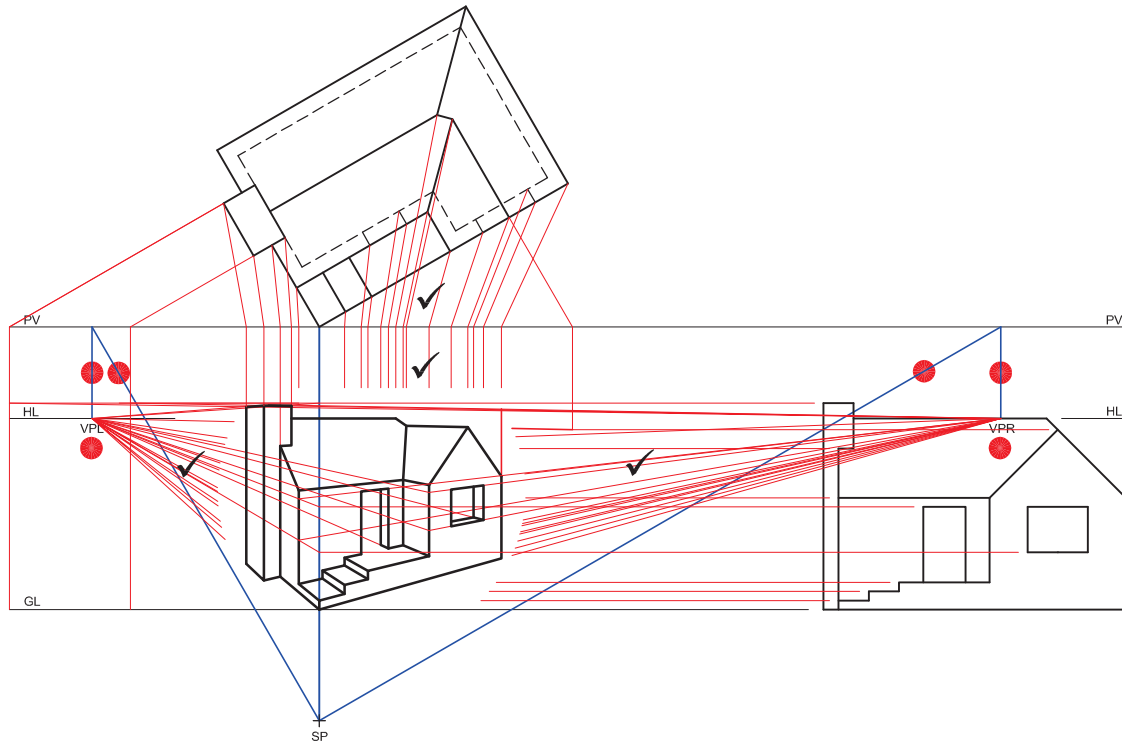

✓ DETAIL VAN PUNTTOEKENNING VIR TRAPPE (7)

SP

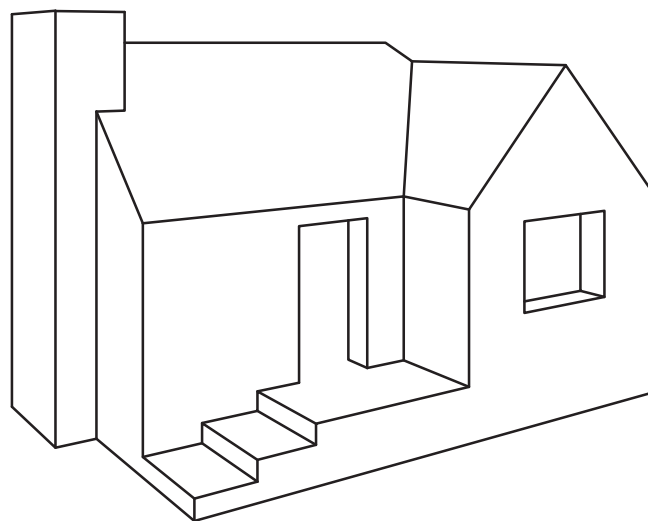

ASSESSERINGSKRITERIA	
KONSTRUKSIES + VP'e	7
GEBOU	18
DAK + SKOORSTEEN	16
TOTAAL	41

VRAESTEL 1 VRAAG 3
 GRAAD 12
 NOVEMBER 2011
 MEMORANDUM

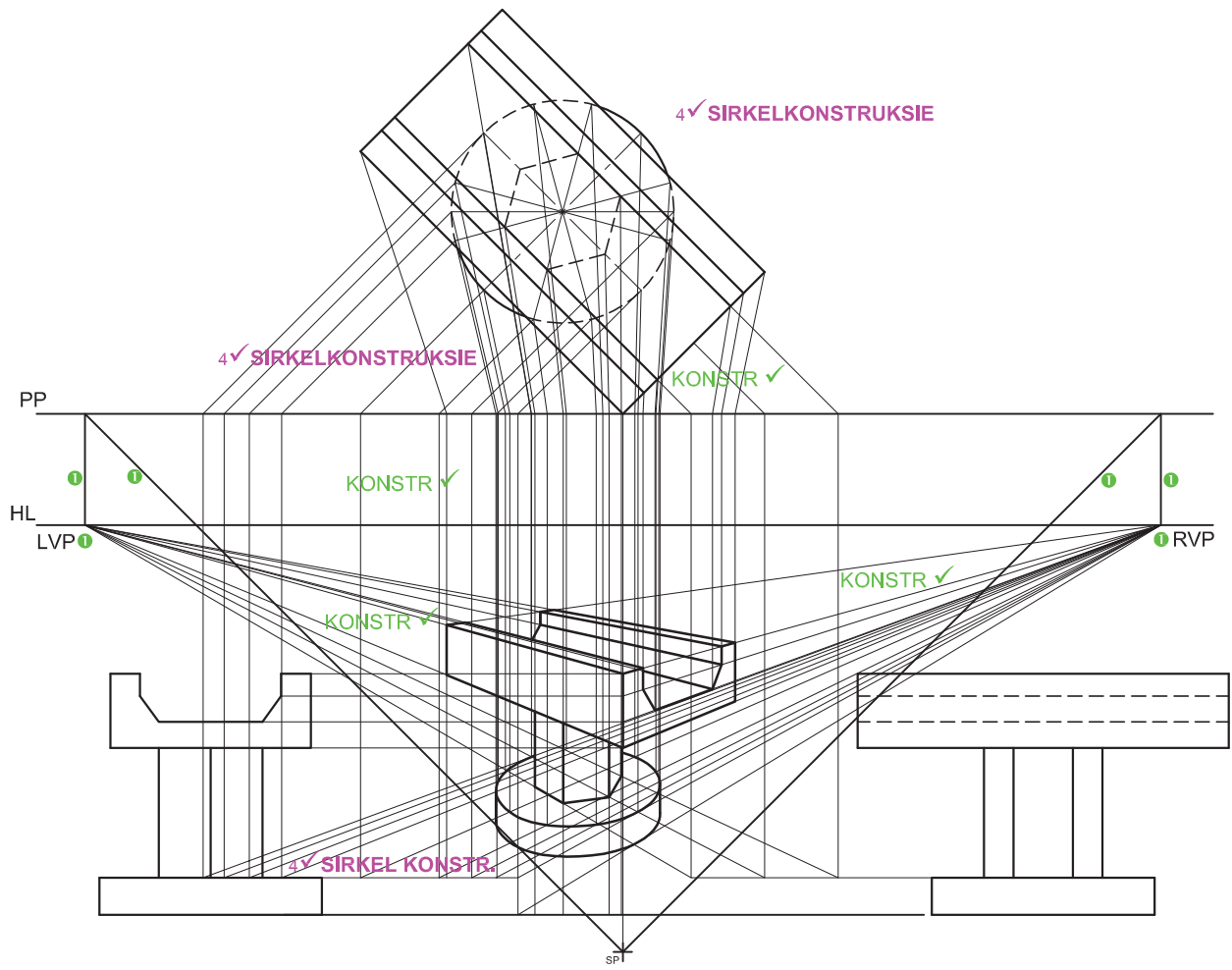

HL

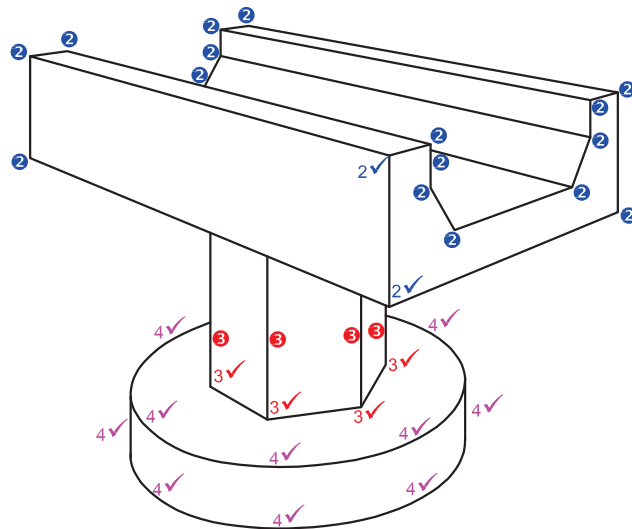

ASSESSERINGSKRITERIA	
1. KONSTRUKSIE + VP'e	7
2. PAD	10
3. SESKANTIGE PILAAR	6
4. RONDE BASIS	13
TOTAAL	36

GL

SP

VRAESTEL 1 VRAAG 3
 GRAAD 12
 FEBRUARIE/MAART 2011
 MEMORANDUM

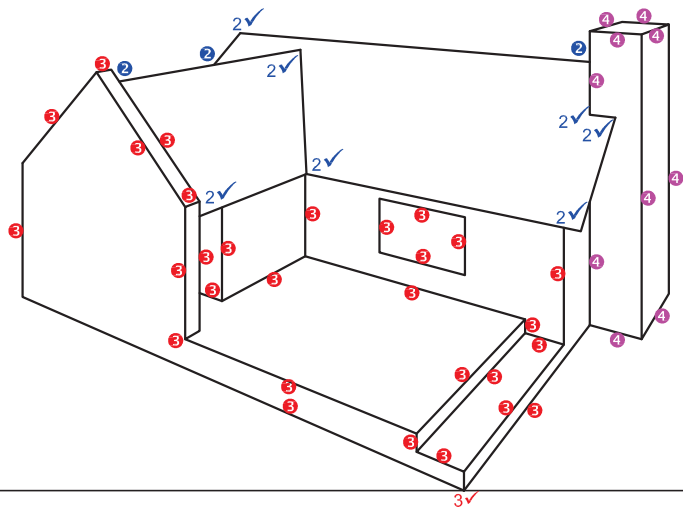
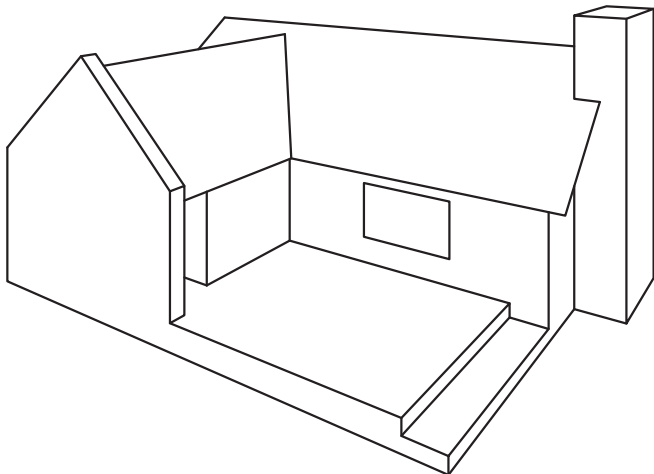
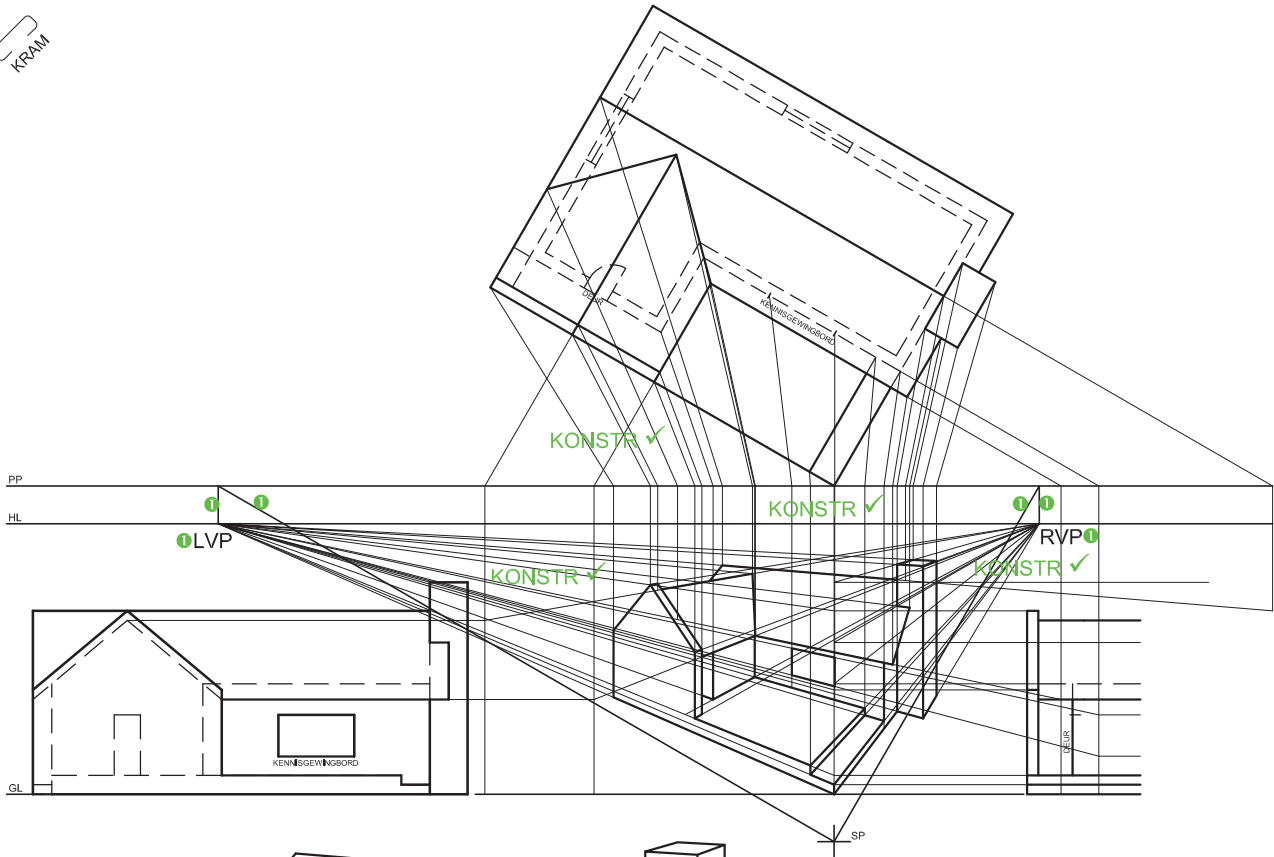

ASSESSERINGSKRITERIA	
1. KONSTRUKSIE + VP'e	7
2. DAK	8½
3. MURE + VENSTER	15½
4. SKOORSTEEN	5
TOTAAL	36

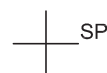

VRAESTEL 1 VRAAG 3
 GRAAD 12
 NOVEMBER 2010
 MEMORANDUM

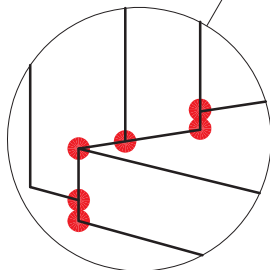
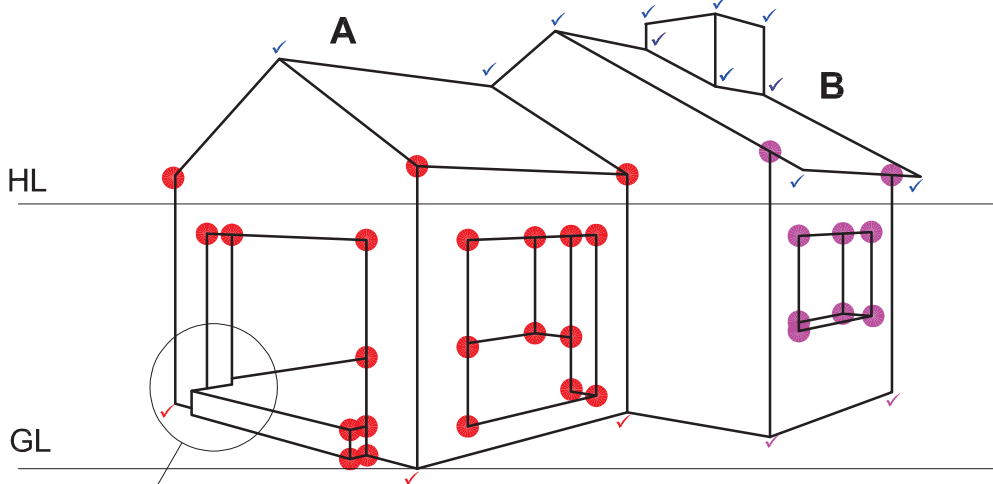
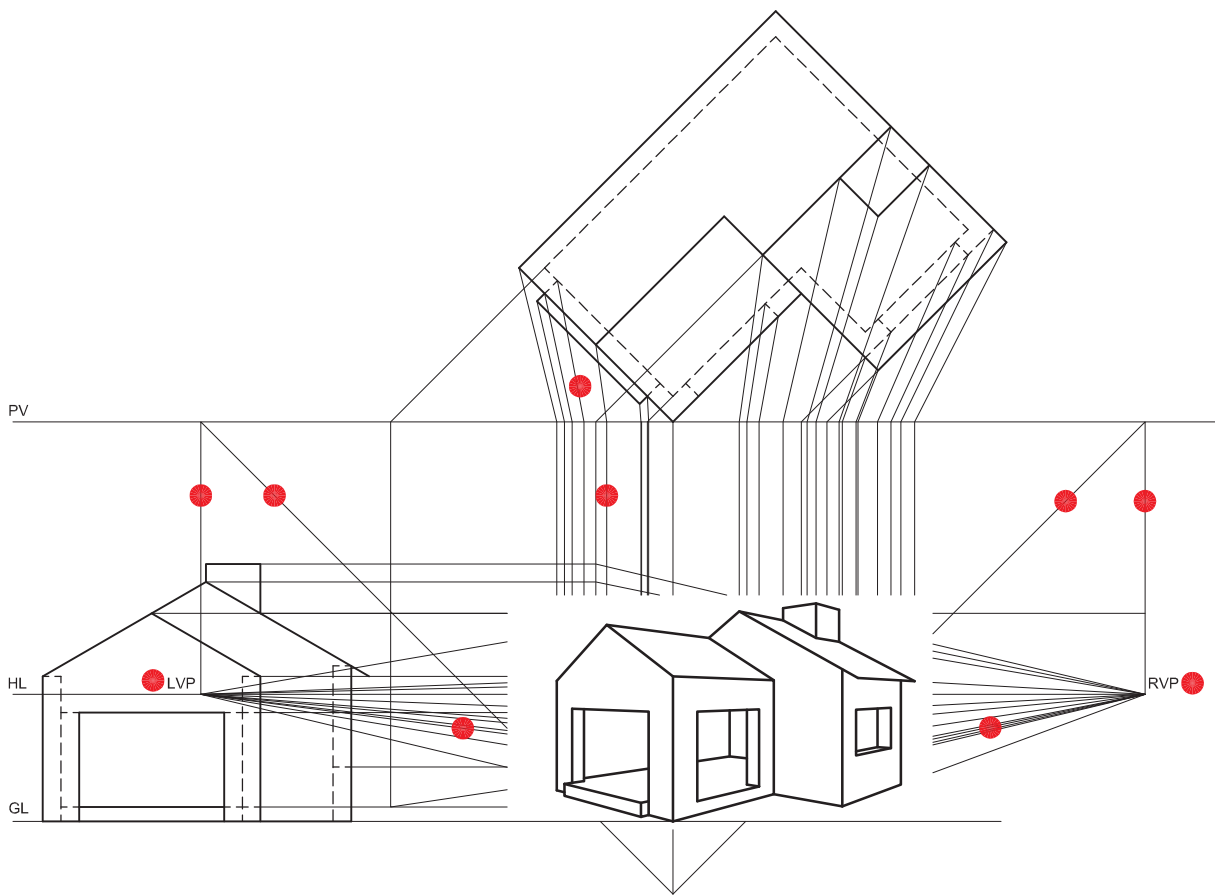

+
SP

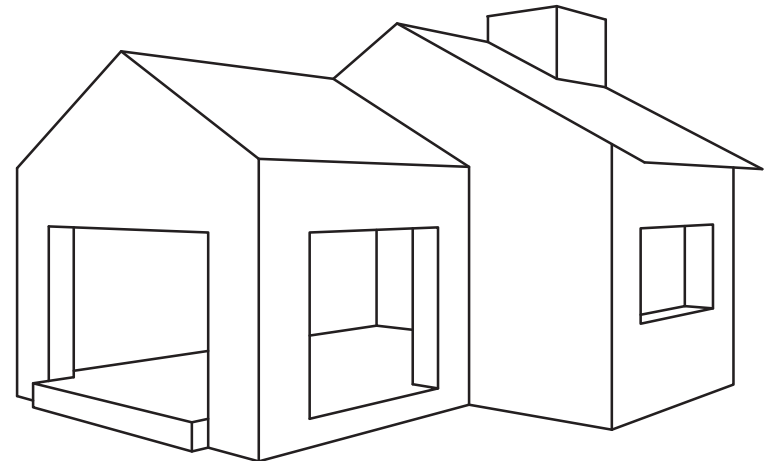

ASSESSERINGSKRITERIA

KONSTRUKSIES + VP'e

DEEL (A)	5
DEEL (B)	16 ¹ / ₂
DAK + SKOORSTEEN	6 ¹ / ₂
TOTAAL	11
	39

VRAESTEL 1 VRAAG 3
GRAAD 12
FEBRUARIE/MAART 2010
MEMORANDUM

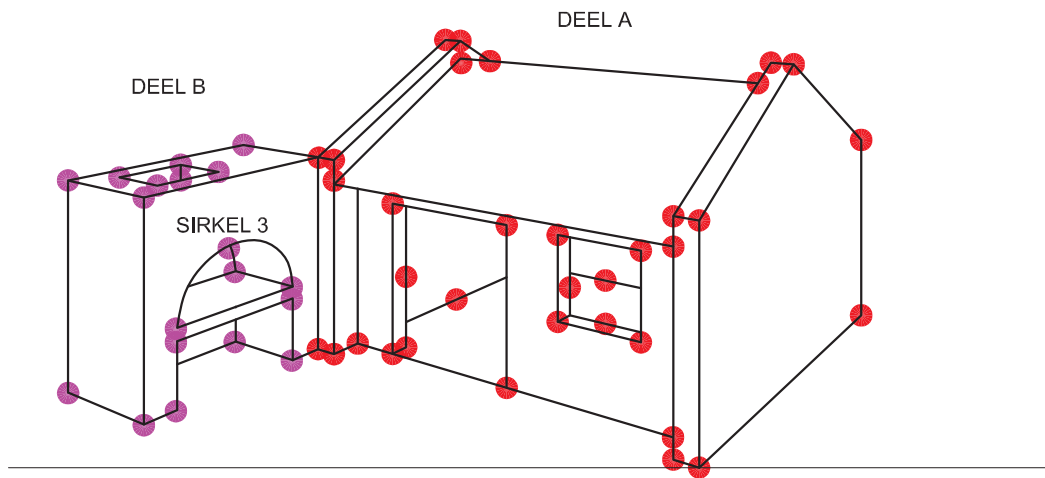
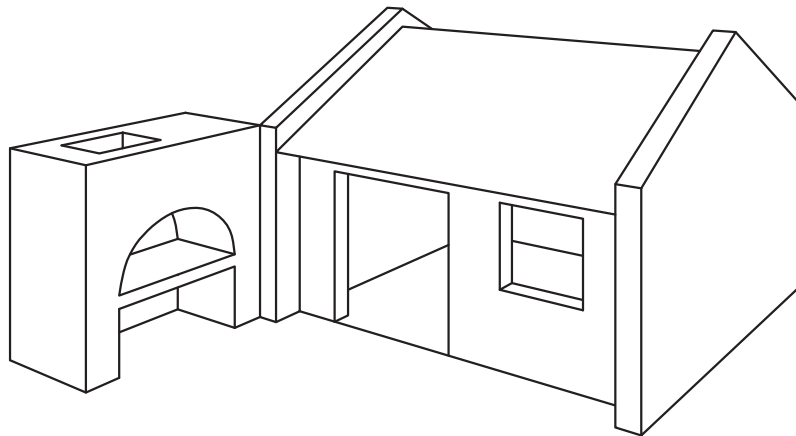
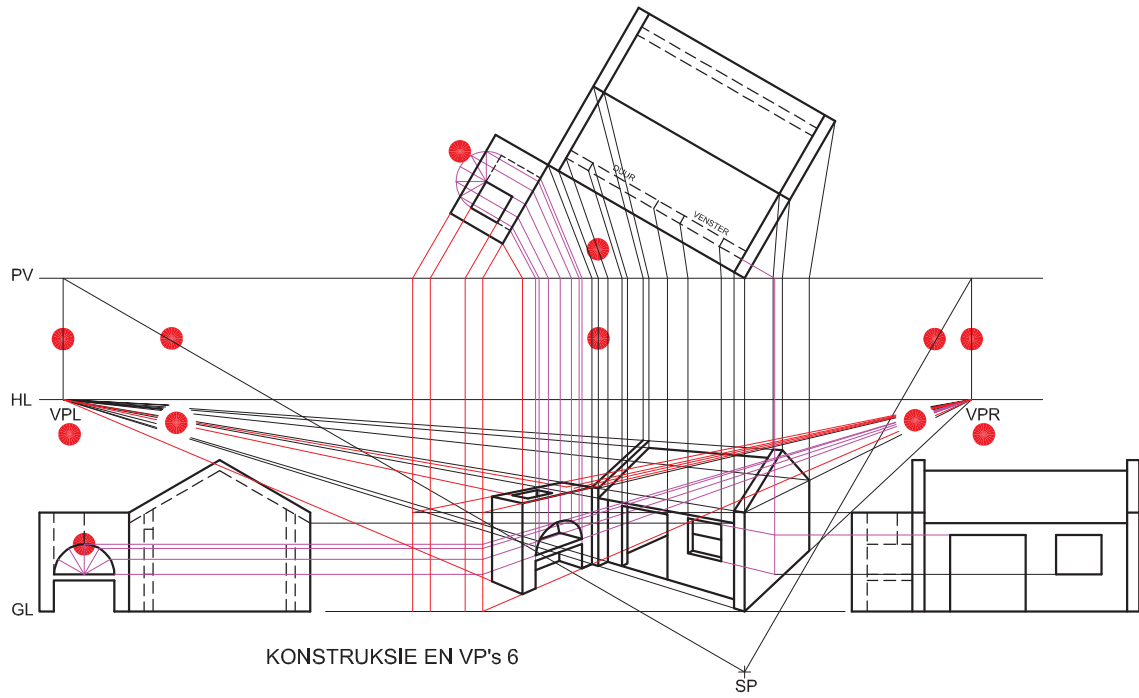

ASSESSERINGSKRITERIA

KONSTRUKSIE + VP's	6
WONING (DEEL A)	17½
BRAAI (DEEL B + SIRKEL)	12½
TOTAAL	36

+

SP

VRAESTEL 1 VRAAG 3
GRAAD 12 NOVEMBER 2009
MEMORANDUM

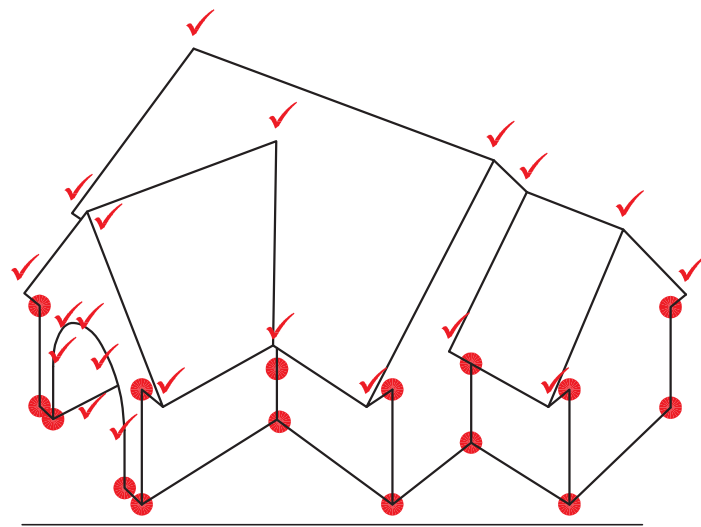
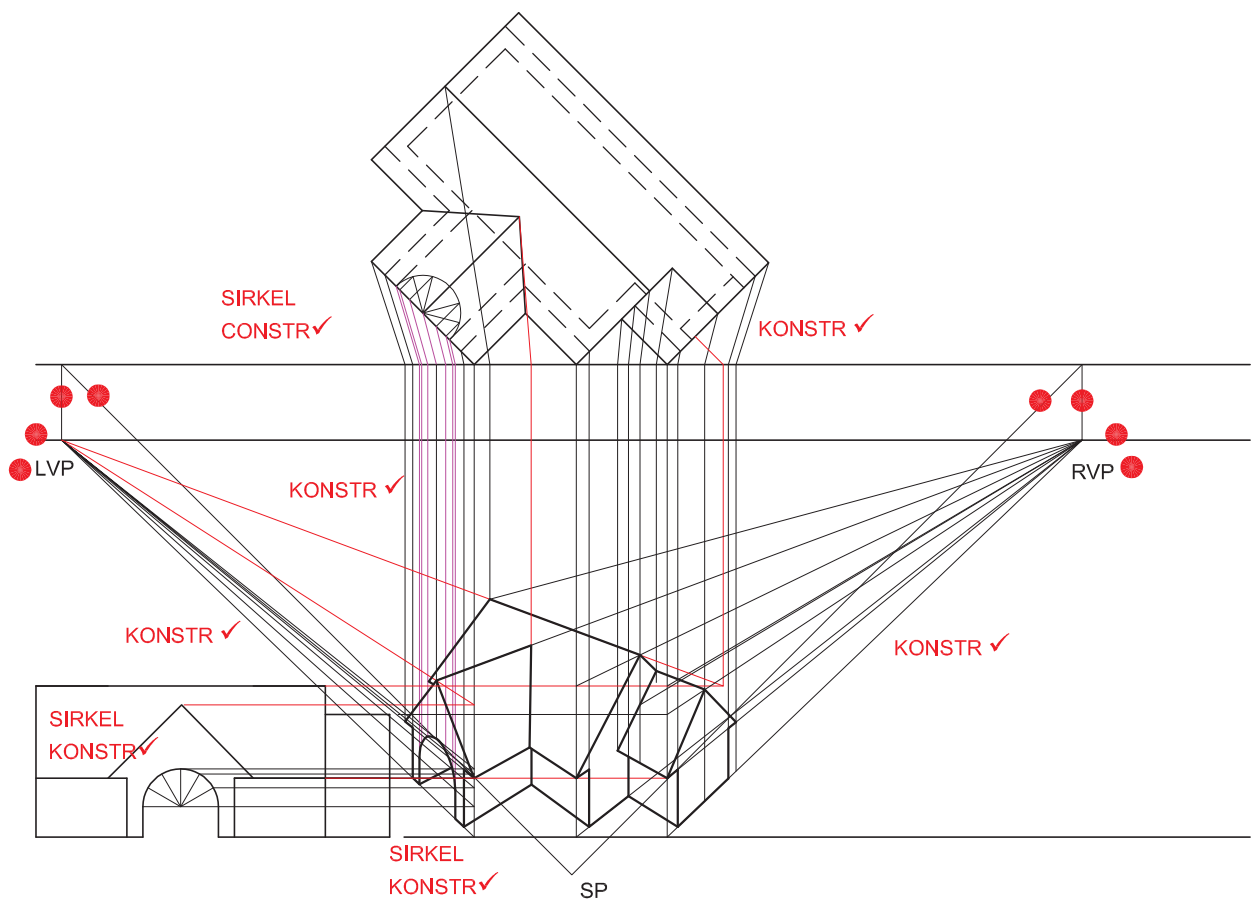

SP

ASSESSERINGSKRITERIA

KONSTRUKSIES	4
BEPAALEN EN BENOEM DIE VP'S	4
SIRKELKONSTRUKSIE	8
DAK	14
MURE, DEUR	9
TOTAAL	39

VRAESTEL 1 VRAAG 3
 GRAAD 12
 FEBRUARIE/MAART 2009
 MEMORANDUM

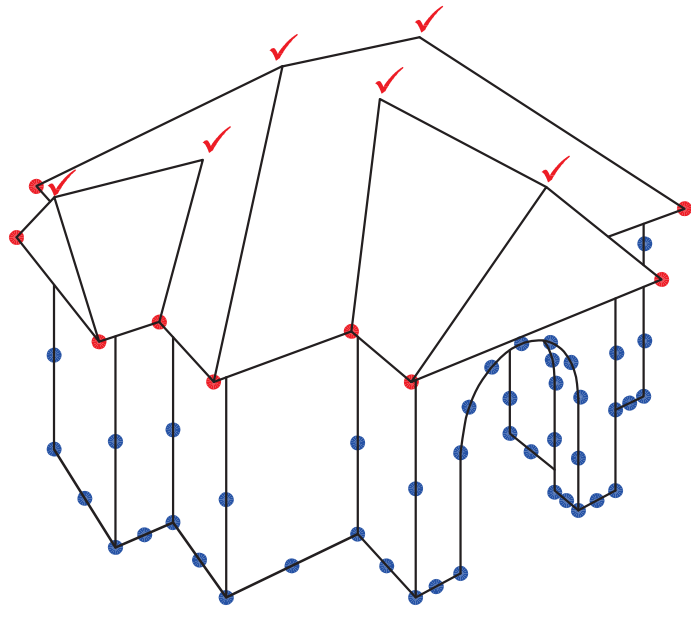
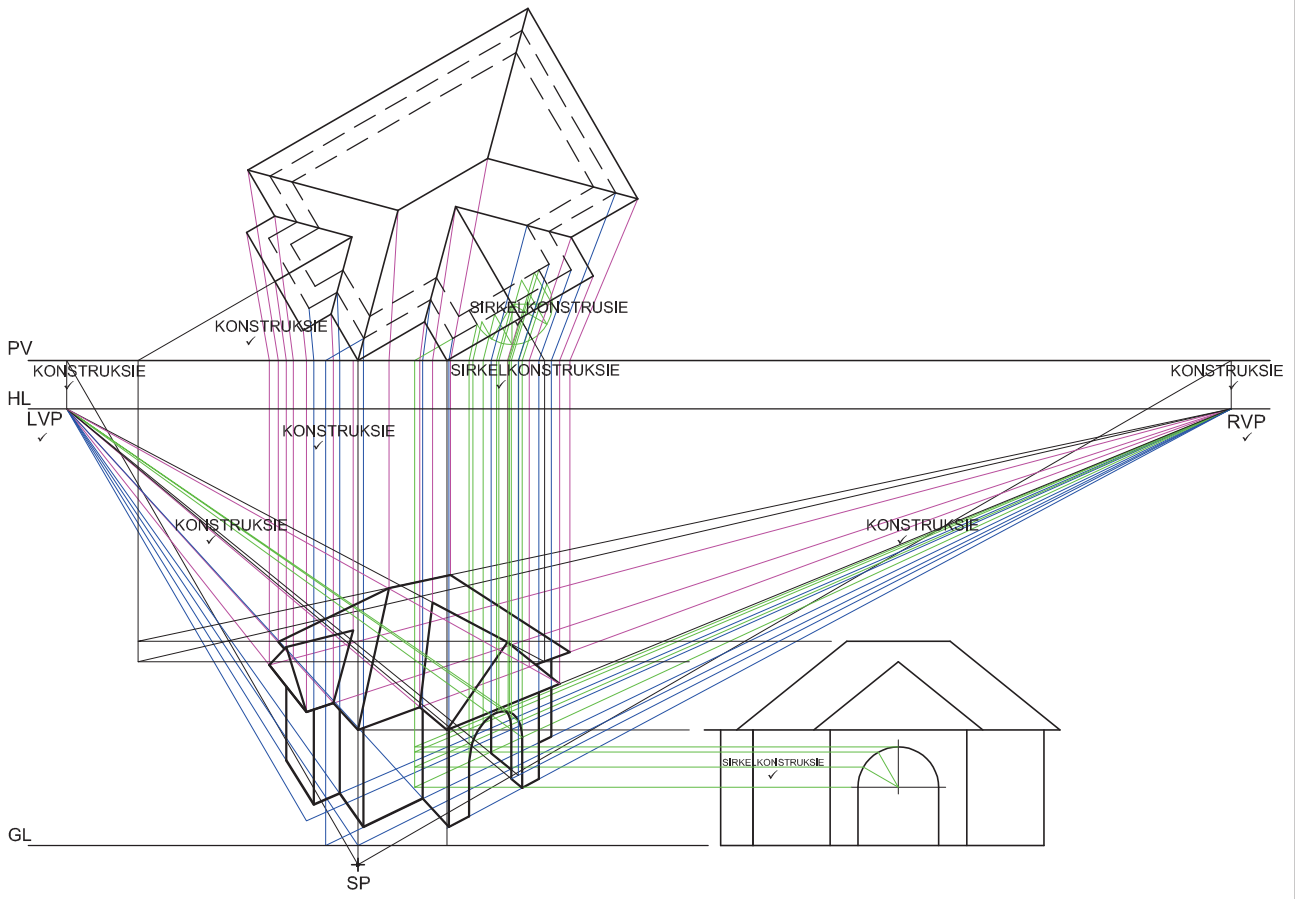

ASSESSERINGSKRITERIA

	+
	SP
KONSTRUKSIES	6
BENOEM DIE VPs	2
SIRKELKONSTRUKSIE	3
DAK	10
MURE, DEUR	22
TOTAAL	43

VRAAG 3 VRAESTEL 1
 GRAAD 12 NOVEMBER 2008
 MEMORANDUM

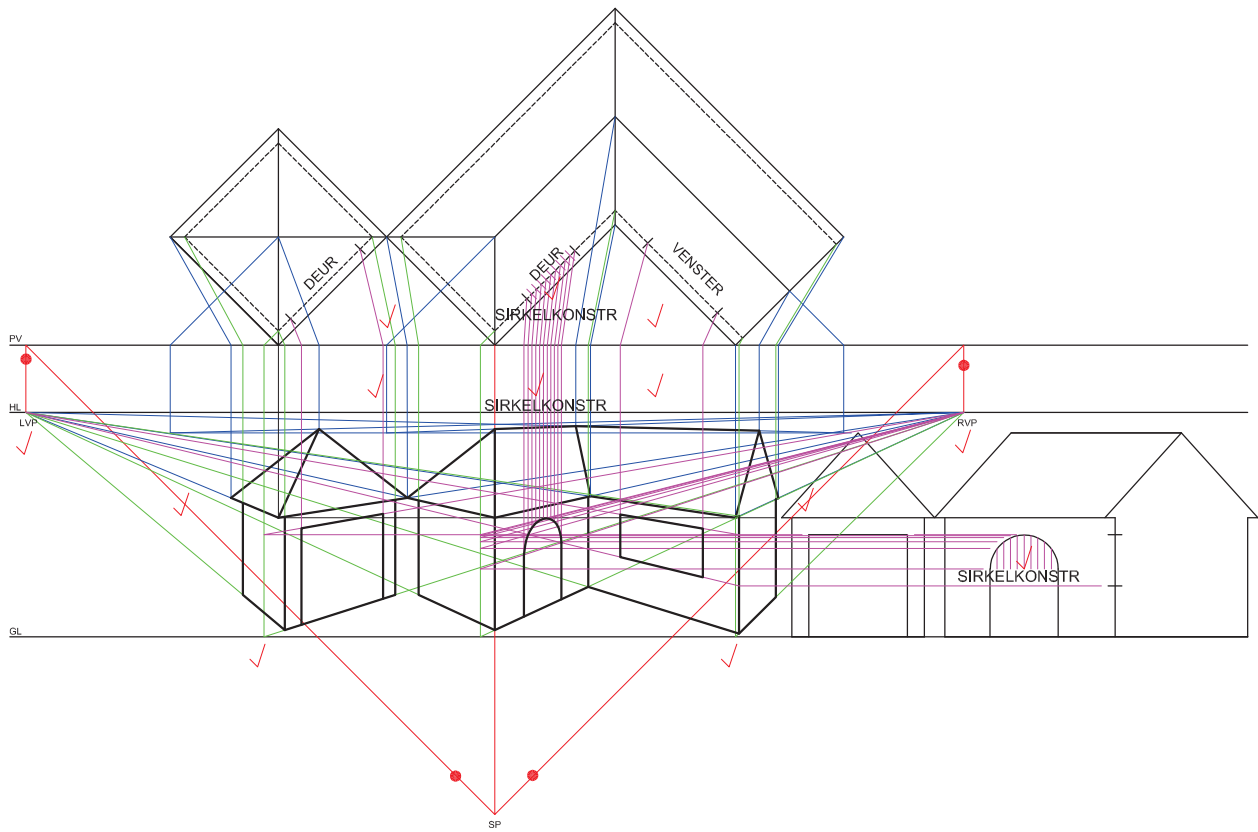

HL

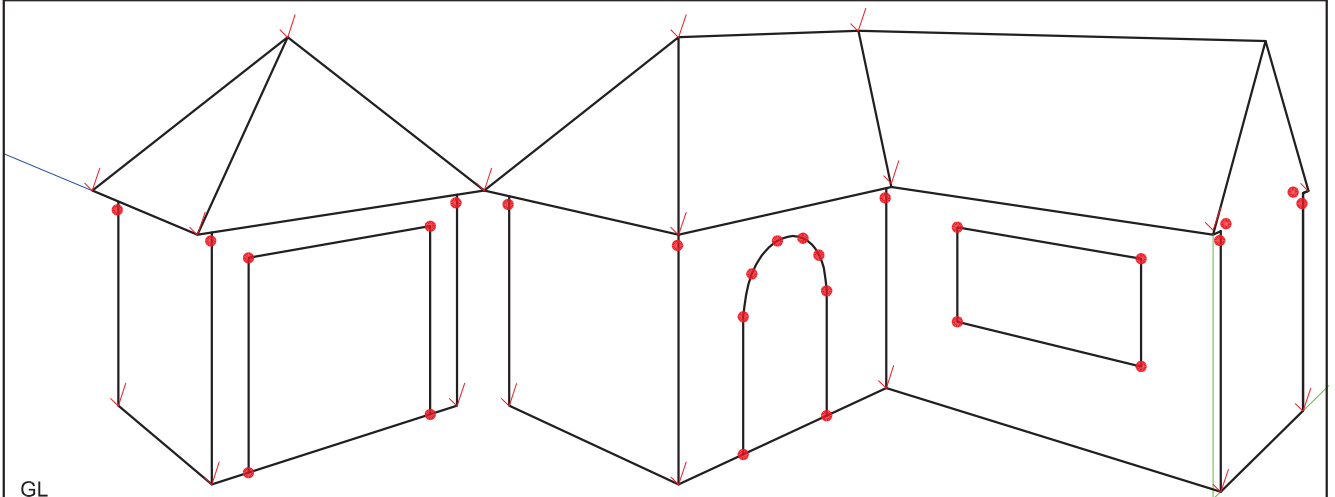

GL

ASSESSERINGSKRITERIA

PROJEKSIES	= 10
SIRKELKONSTRUKSIE	= 3
DAK	= 11
MURE, VENSTER, DEURE	= 21
TOTAAL	45

SP

2008 GRAAD 12
VRAESTEL 1
MODEL
VRAAG 3
MEMORANDUM