

ASSESSMENT CRITERIA	
1	PLACING + AUX. VIEWS
2	FRONT + MIDDLE SURFACES
3	SECTIONED SURFACE + HATCHING
4	CIRCLE + CL
TOTAL 40	

PAPER 2 QUESTION 3
 GRADE 12
 NOVEMBER 2023
 MARKING GUIDELINE

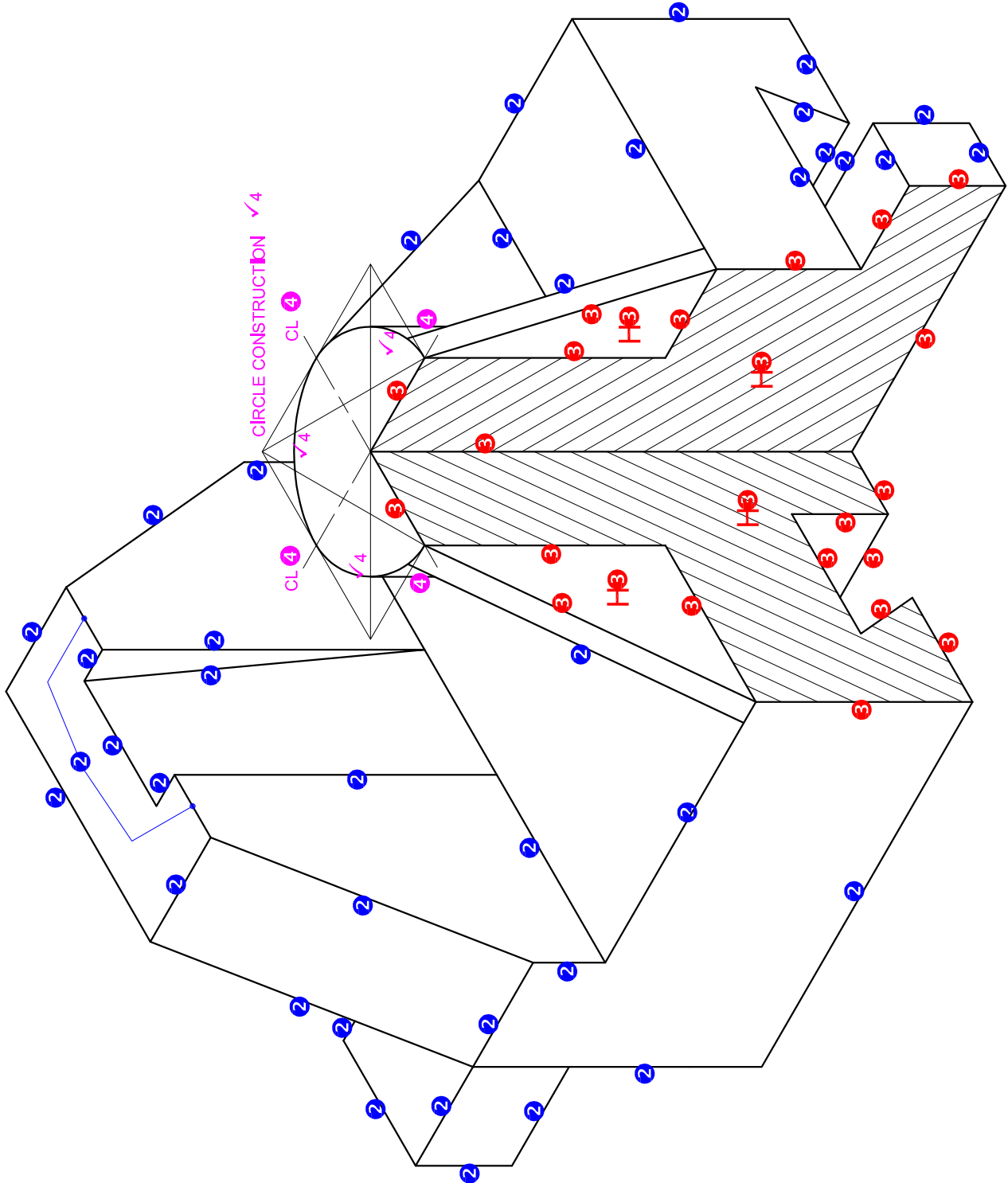

✓1 PLACEMENT/ORIENTATION

ARC CONSTRUCTION ✓ 4

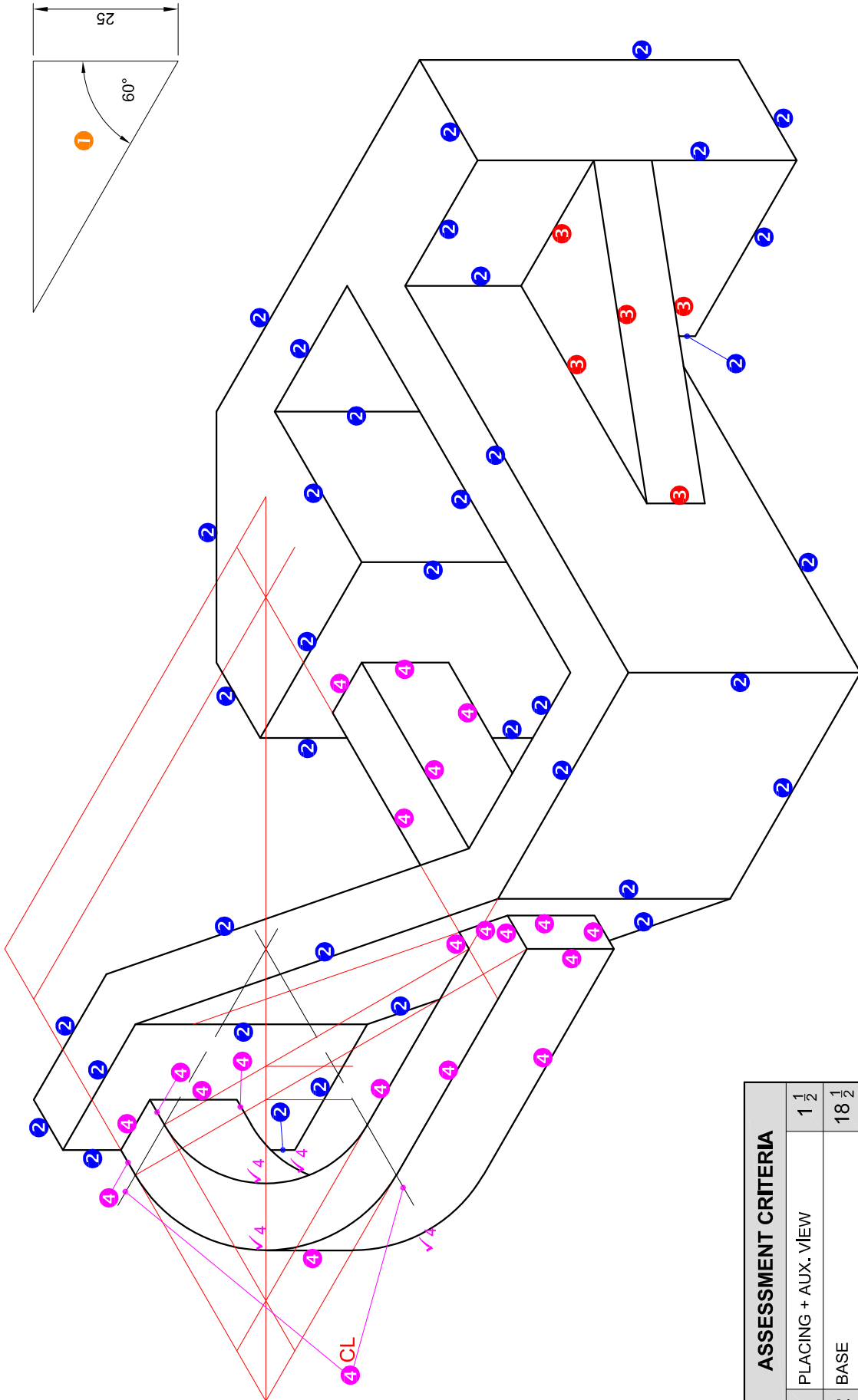

P ✓ 1 PLACEMENT / ORIENTATION

PAPER 2 QUESTION 3
 GRADE 12
 JUNE 2023
 MARKING GUIDELINE

ASSESSMENT CRITERIA		
1	PLACING + AUX. VIEW	1 1/2
2	BASE	18 1/2
3	WEB	2 1/2
4	CIRCLE + CENTRE LINES + BRACE	15 1/2
TOTAL		38

ASSESSMENT CRITERIA		
1	PLACING + AUX. VIEW	2
2	BODY	20
3	HANDLE	9 1/2
4	CIRCLES + CONSTR. + CL	8 1/2
TOTAL		40

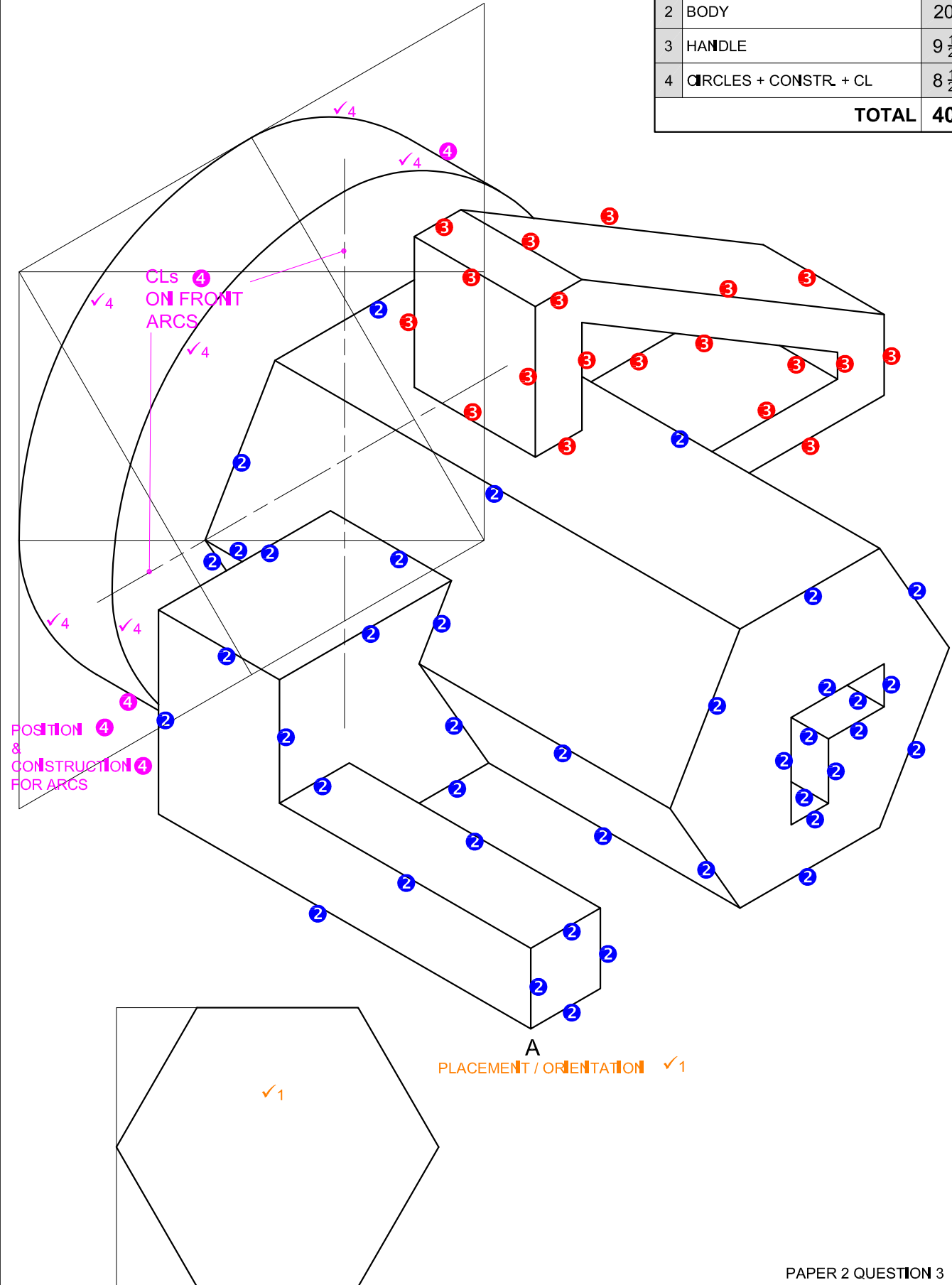

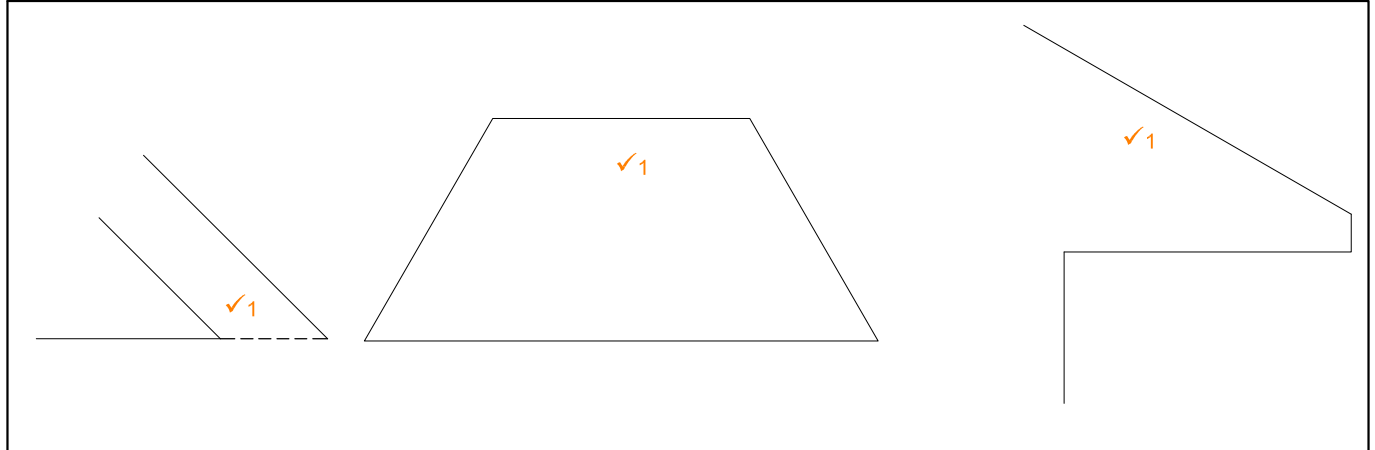

ASSESSMENT CRITERIA		
1	PLACING + AUX VIEWS	4
2	LEFT SECTION	17
3	MIDDLE SECTION	7 1/2
4	RIGHT SECTION	5
5	CIRCLE + CENTRE LINES + CONSTR'	5 1/2
TOTAL		39

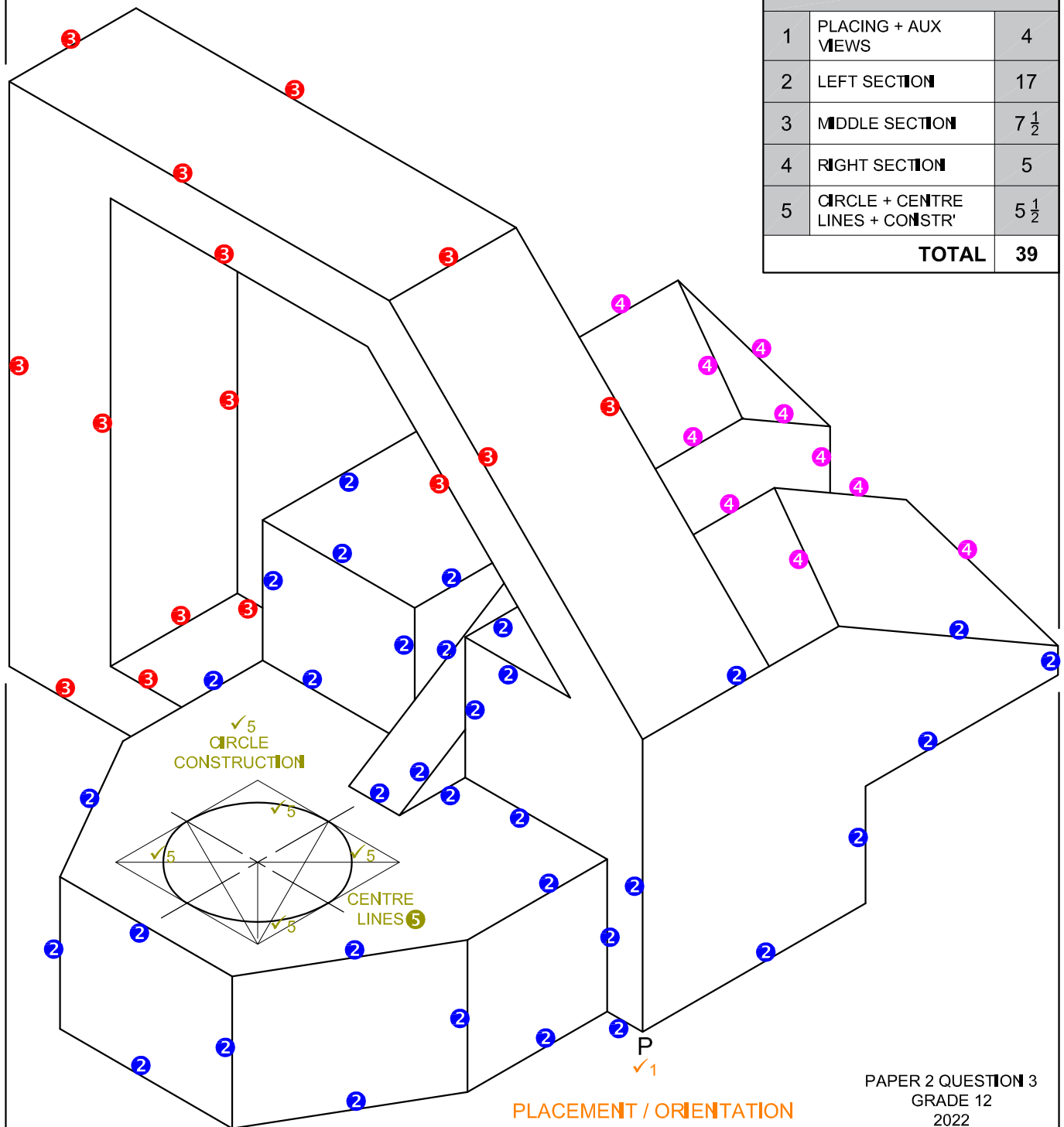

PAPER 2 QUESTION 3
 GRADE 12
 2022
 MARKING GUIDELINES

ASSESSMENT CRITERIA	
1	PLACING + AUX. VIEW
2	FRONT + MIDDLE SURFACES
3	SLOPED SURFACE
4	CIRCLE + HEXAGON
TOTAL 40	

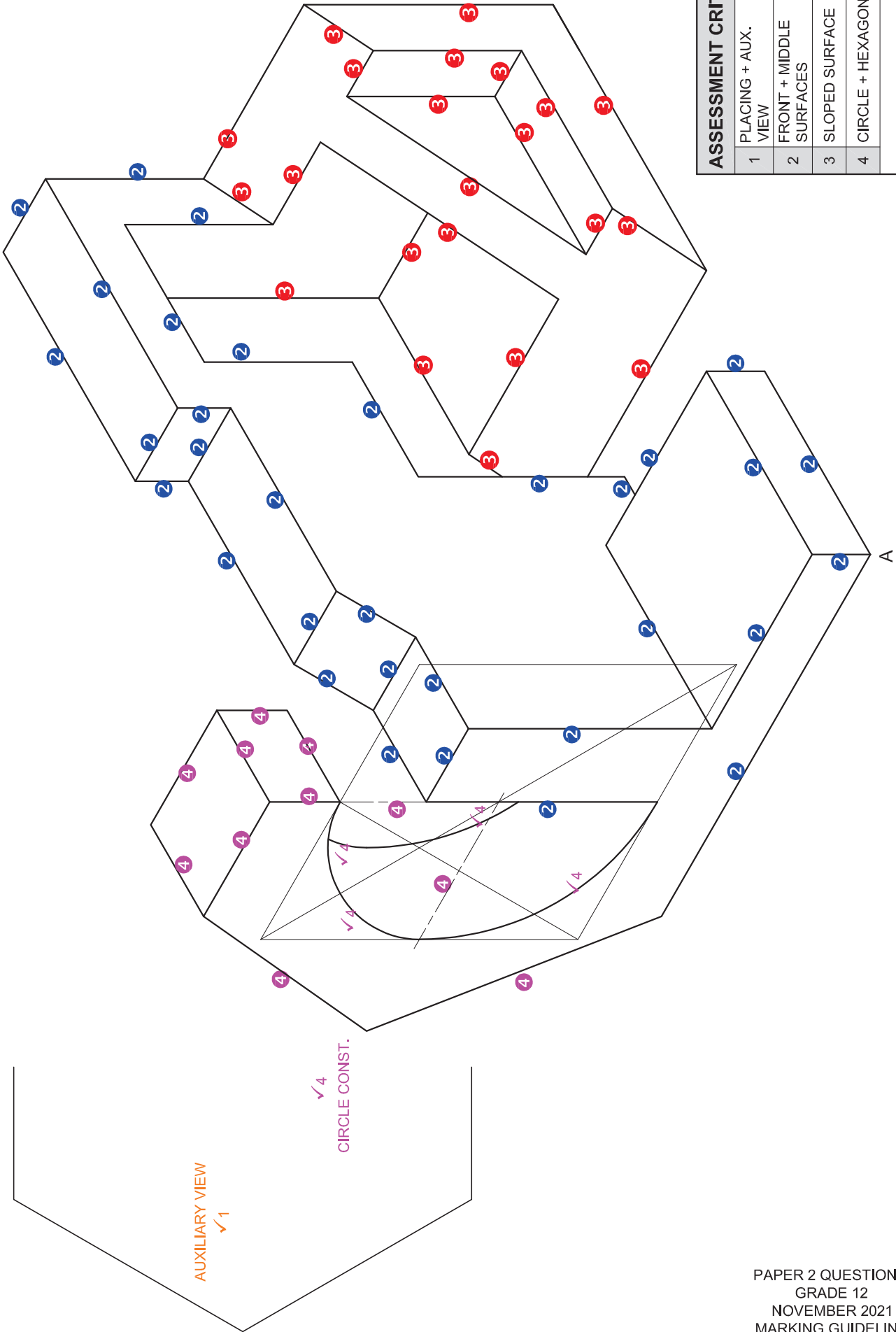

✓ 1 CORRECT PLACEMENT / ORIENTATION

PAPER 2 QUESTION 3
 GRADE 12
 NOVEMBER 2021
 MARKING GUIDELINE

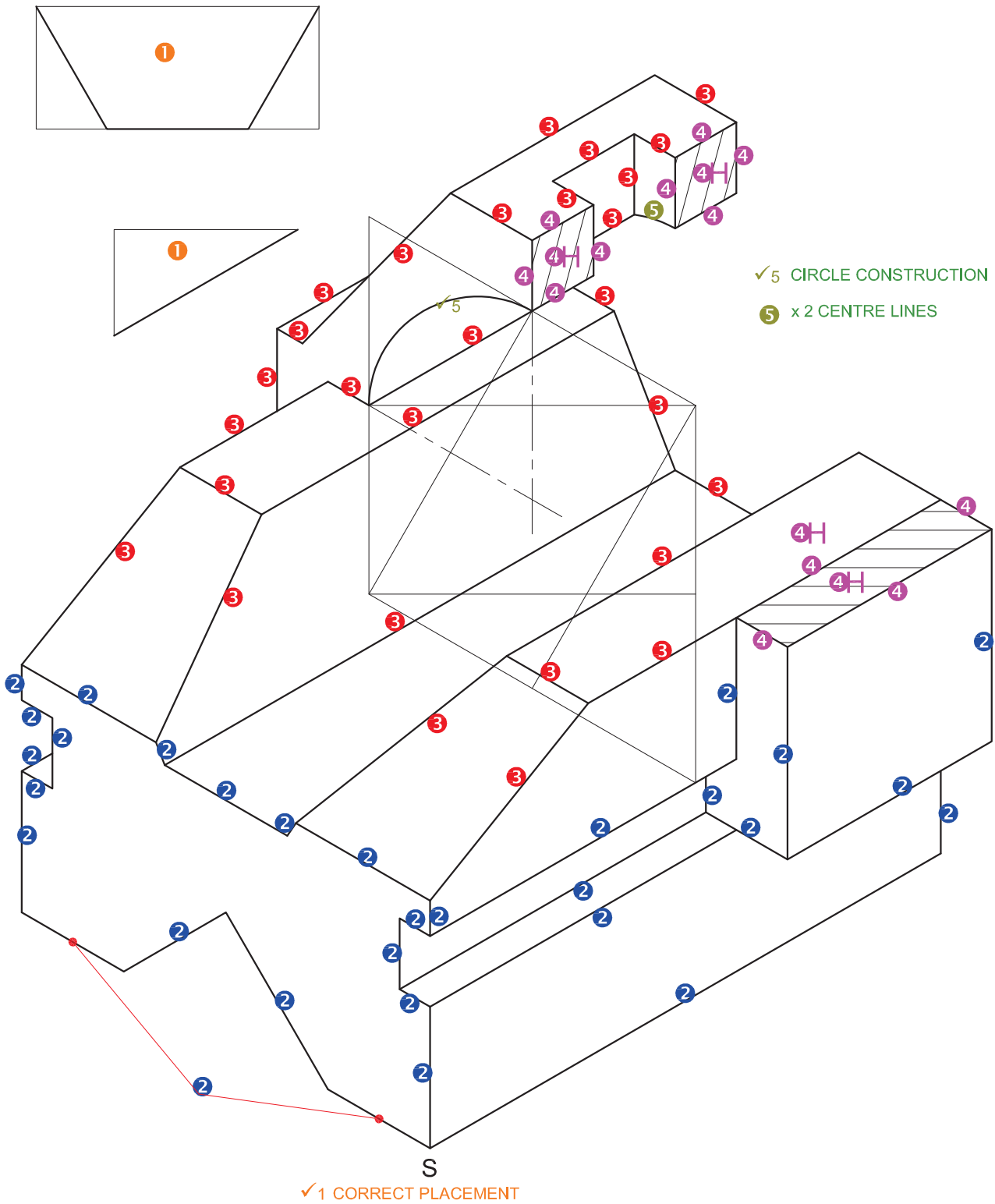

PAPER 2 QUESTION 3
 GRADE 12
 2021
 MARKING GUIDELINES

ASSESSMENT CRITERIA		
1	AUX. VIEW + PLACING	2
2	LOWER PORTION	15
3	UPPER PORTION	14
4	SECTION	8
5	ISO CIRCLES + CIRCLE CONSTR' + CENTRE LINES	3
TOTAL		42

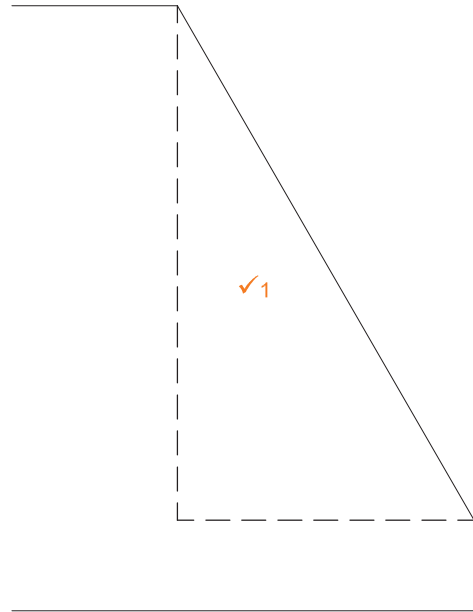
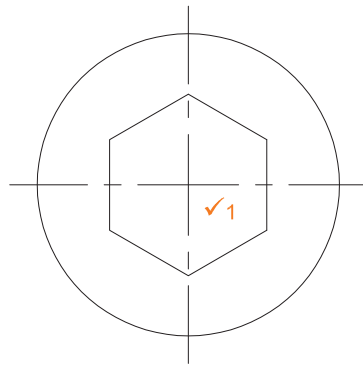

✓4 CIRCLE CONSTRUCTION

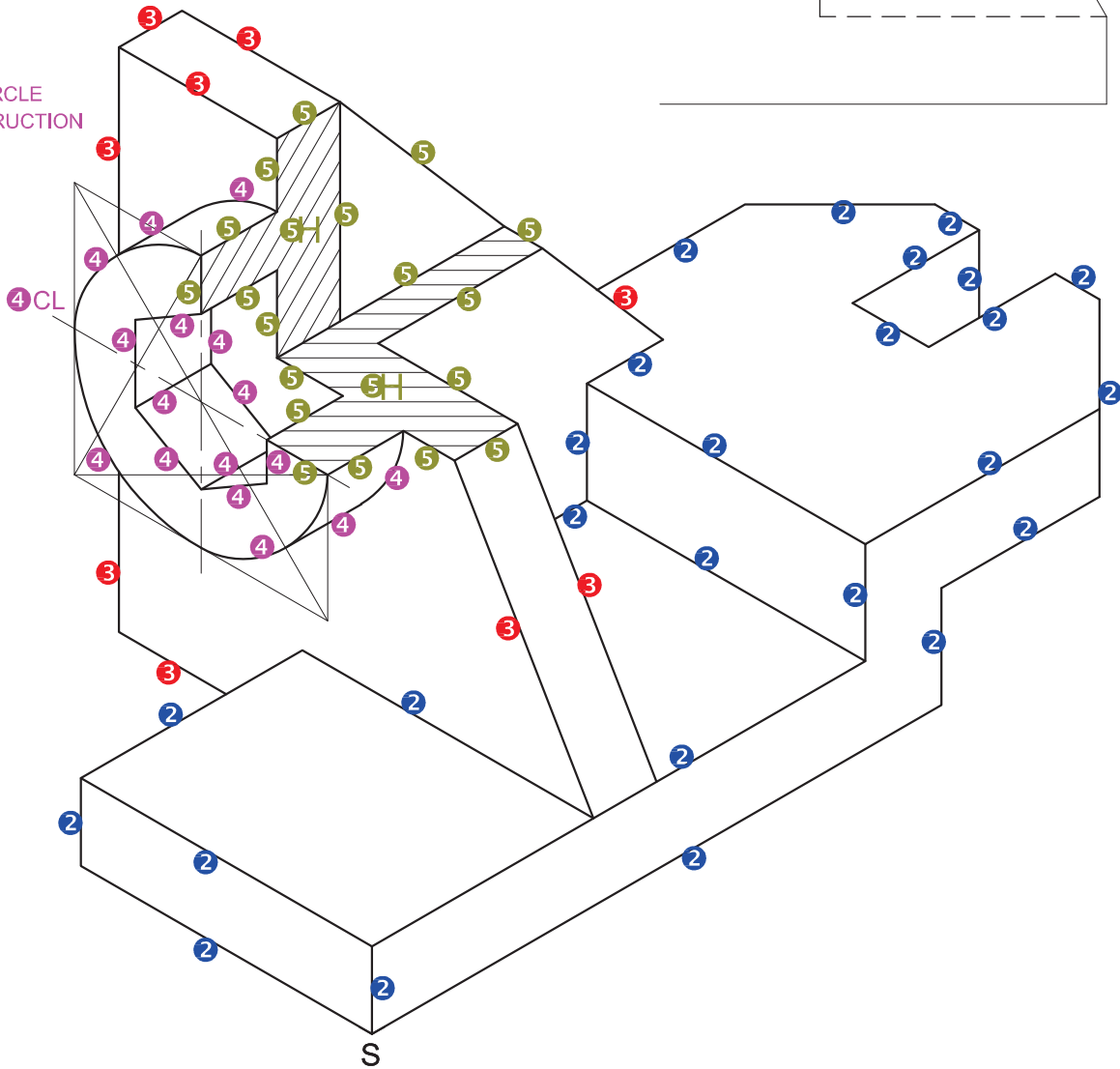

✓1 PLACEMENT

ASSESSMENT CRITERIA		
1	PLACEMENT + AUX VIEW	3
2	BASE	13
3	UPRIGHT	4½
4	CIRCLE + HEXAGON	9½
5	SECTION	10
TOTAL		40

PAPER 2 QUESTION 3
 GRADE 12
 SC/NSC 2020
 MARKING GUIDELINE

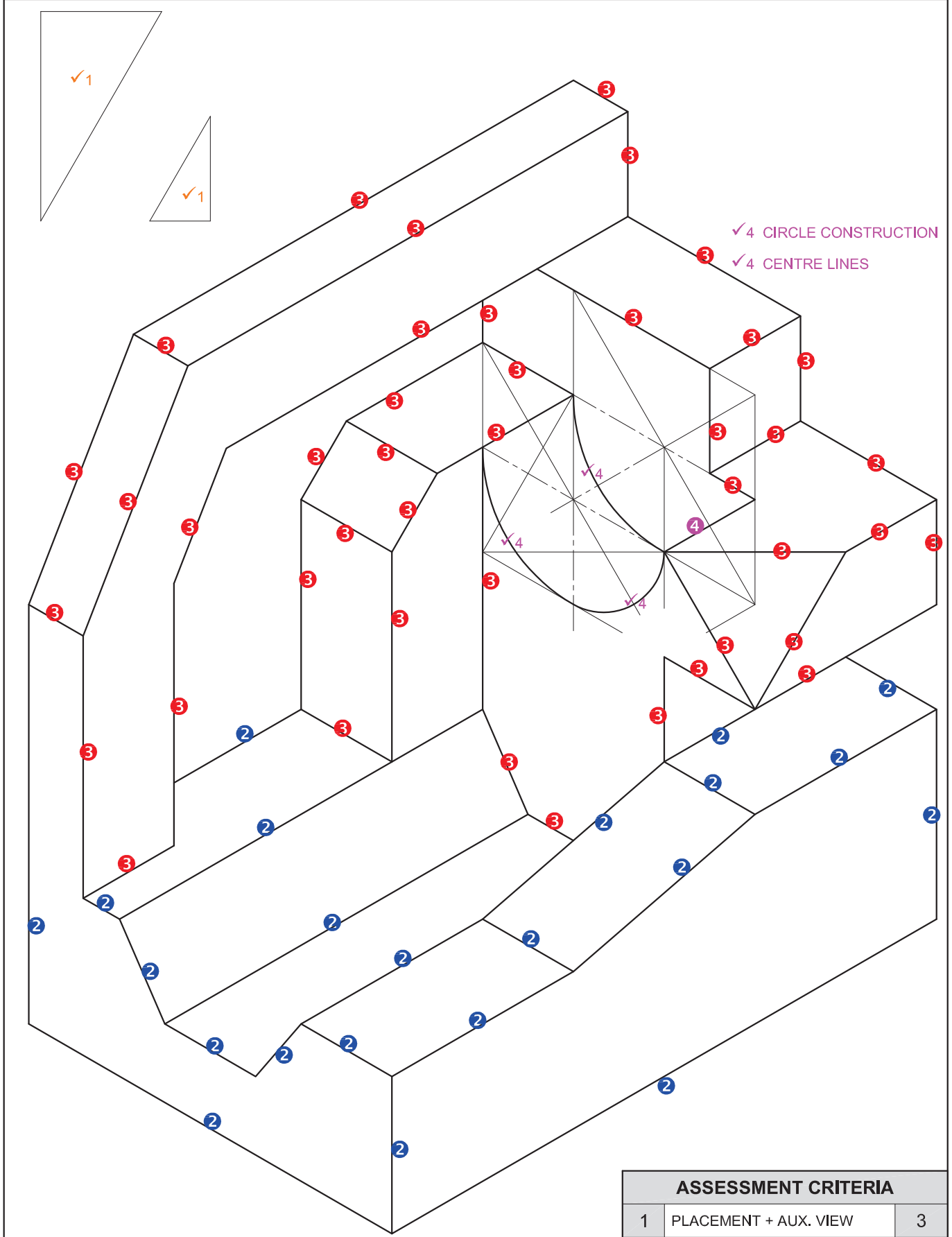

✓4 CIRCLE CONSTRUCTION
 ✓4 CENTRE LINES

✓1 CORRECT PLACEMENT

PAPER 2 QUESTION 3
 GRADE 12
 NSC 2019
 MARKING GUIDELINES

ASSESSMENT CRITERIA		
1	PLACEMENT + AUX. VIEW	3
2	FRONT PORTION	11
3	BACK PORTION	21 ¹ / ₂
4	CIRCLE + CIRCLE CONSTRUCTION + CL	5 ¹ / ₂
TOTAL		41

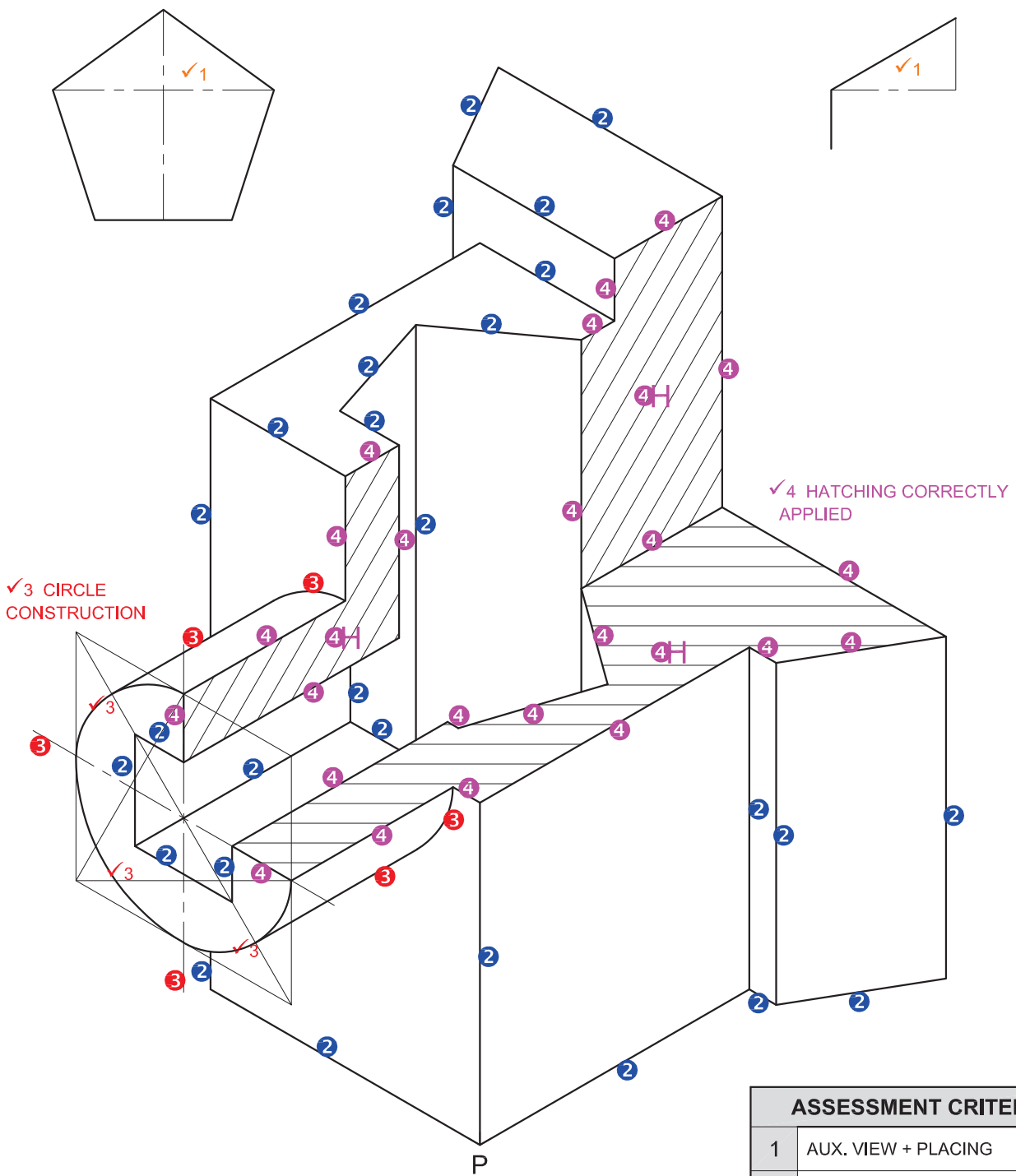

ASSESSMENT CRITERIA		
1	AUX. VIEW + PLACING	3
2	ISOMETRIC + NON-ISO' LINES	14
3	ISOMETRIC CIRCLES + CIRCLE CONSTR'	7
4	SECTIONED SURFACES + HATCHING	14
TOTAL		38

PAPER 2 QUESTION 3
 GRADE 12
 SC/NSC 2019
 MARKING GUIDELINE

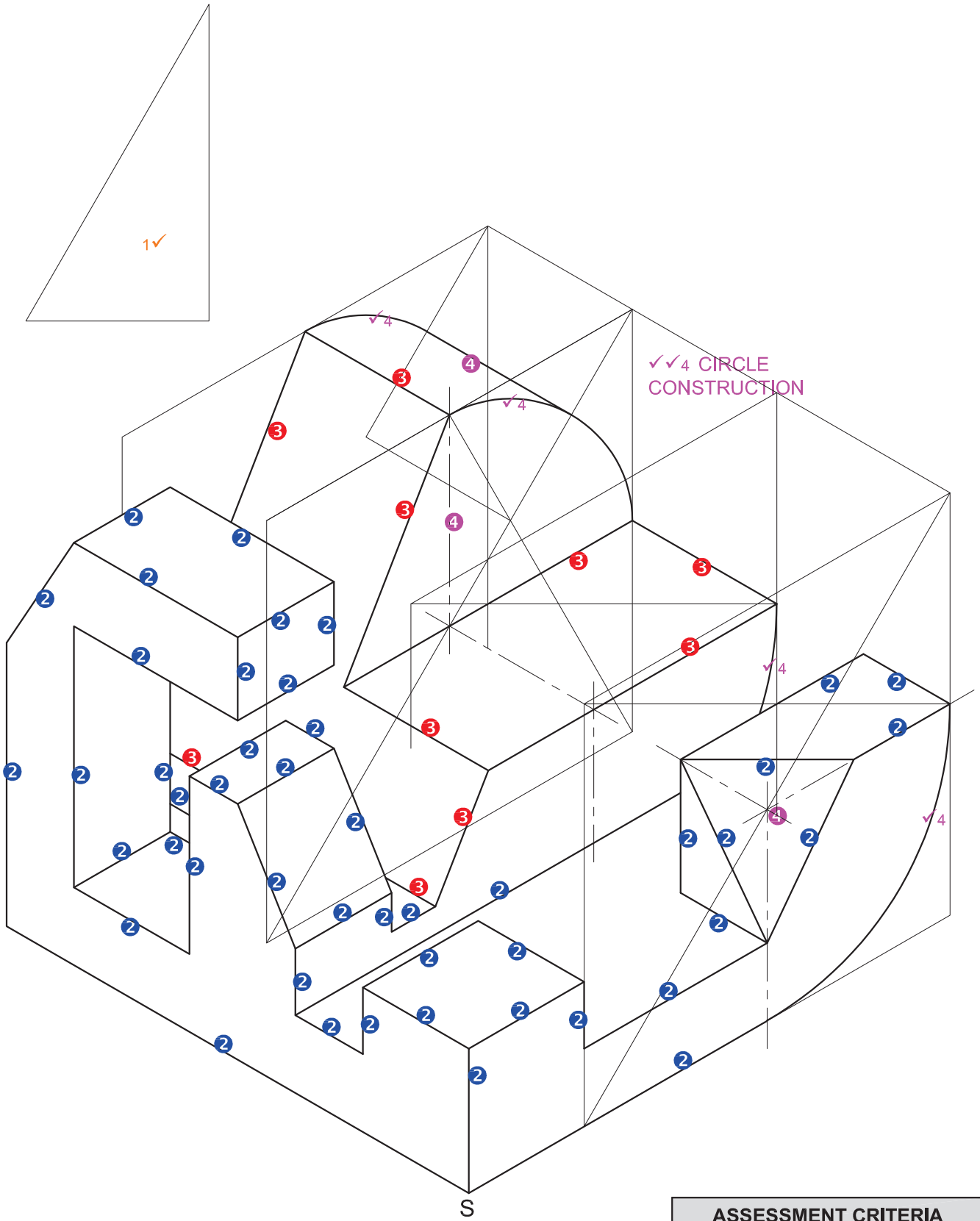

✓1 CORRECT PLACEMENT

✓✓4 CIRCLE CONSTRUCTION

S

ASSESSMENT CRITERIA		
1	PLACEMENT + AUX. VIEW	2
2	FRONT PORTION	23½
3	BACK PORTION	5
4	CIRCLE +CIRCLE CONSTRUCTION + CL	7½
TOTAL		38

PAPER 2 QUESTION 3
 GRADE 12
 NOVEMBER 2018
 MARKING GUIDELINE

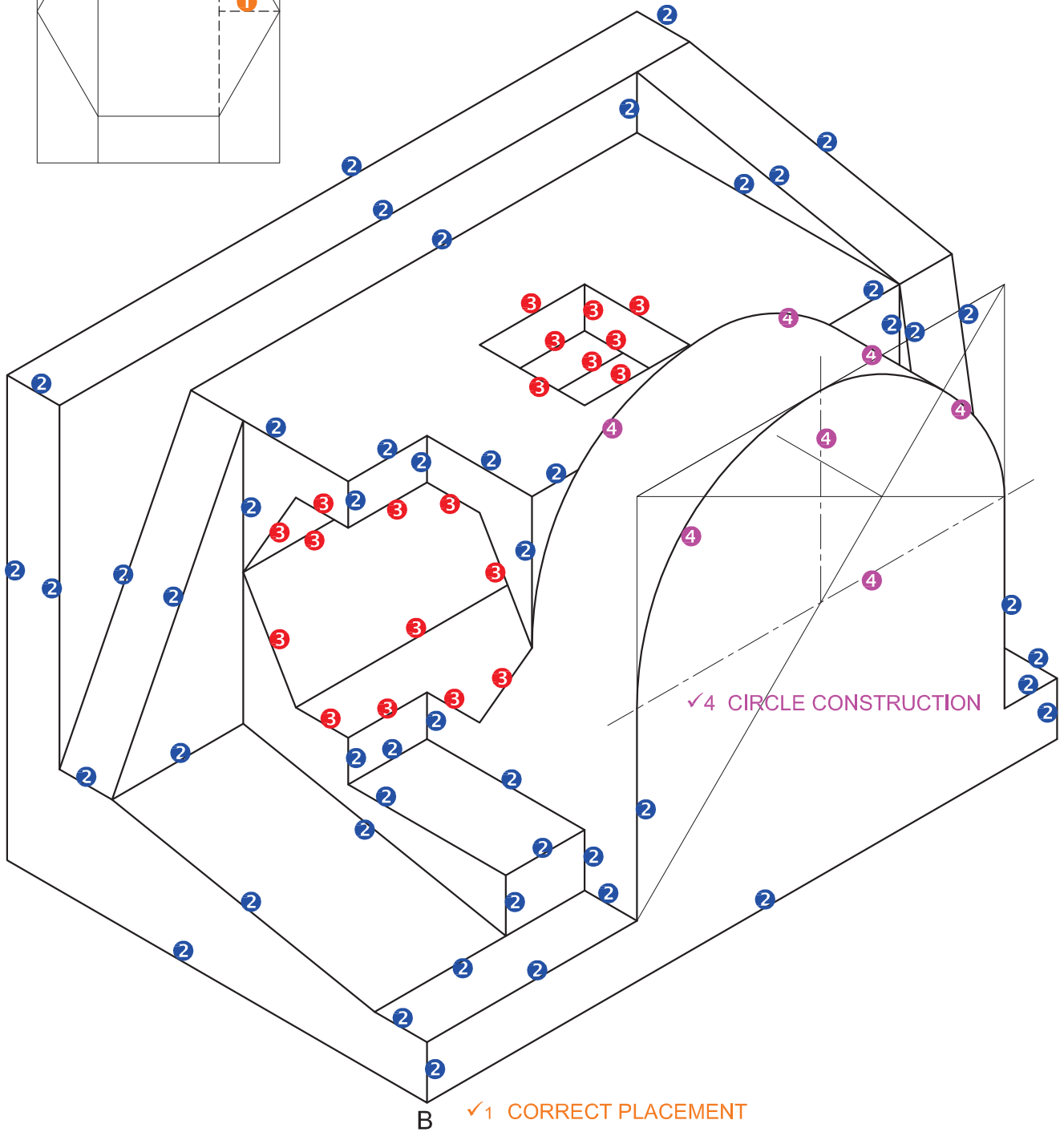
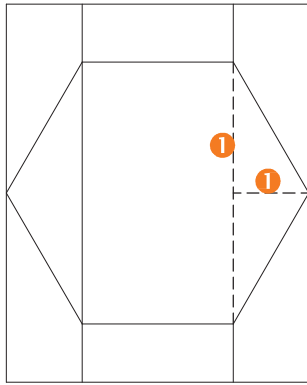

PAPER 2 QUESTION 3
 GRADE 12
 SCE 2018
 MARKING GUIDELINE

ASSESSMENT CRITERIA		
1	PLACEMENT + AUX. VIEW	2
2	ISOMETRIC + NON ISOMETRIC LINES	24 $\frac{1}{2}$
3	HEXAGON + SQUARE	10
4	CIRCLE + CIRCLE CONSTRUCTION + CL	4 $\frac{1}{2}$
TOTAL		41

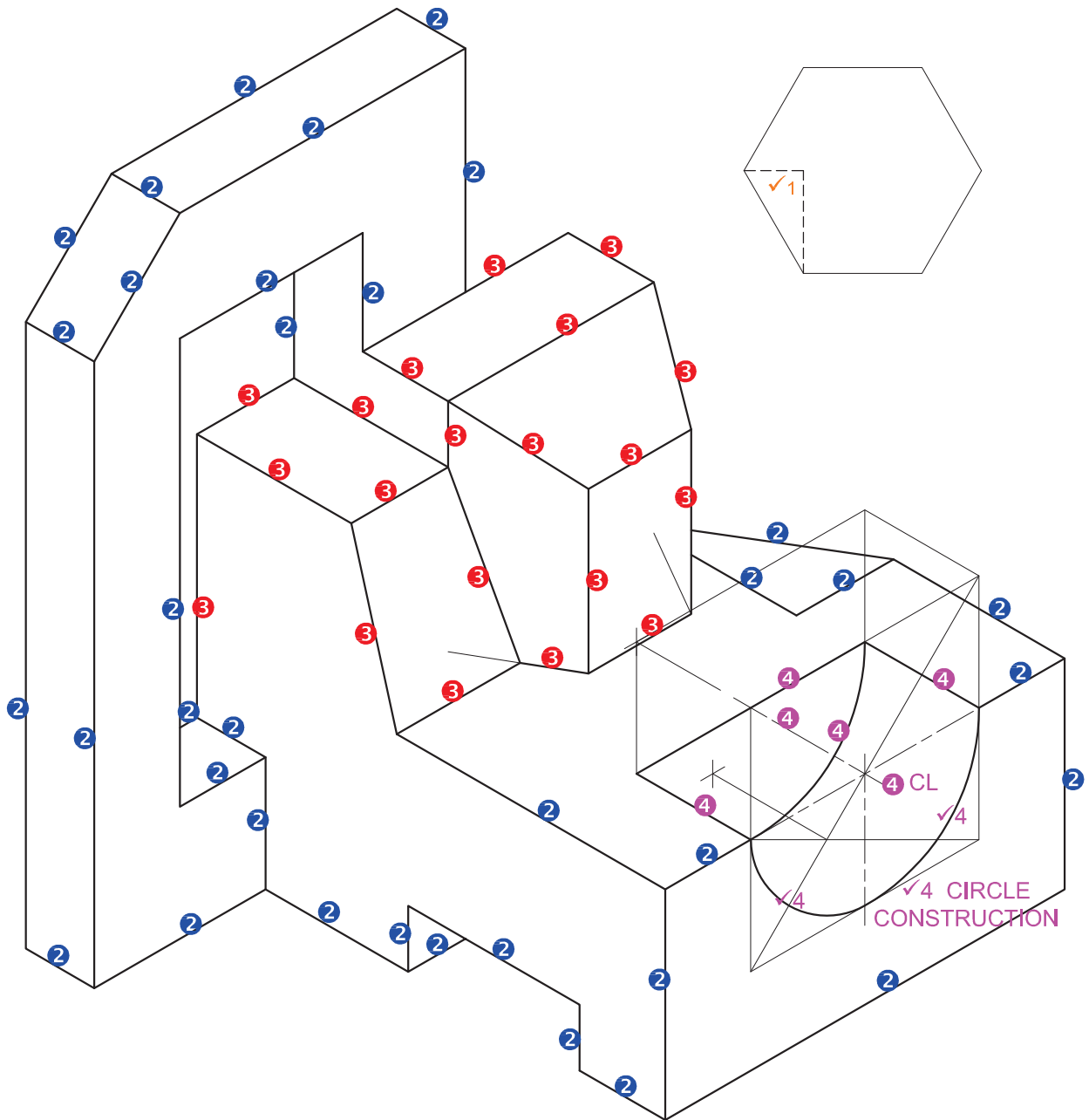

B ✓1 CORRECT PLACEMENT

ASSESSMENT CRITERIA		
1	PLACEMENT + AUX. VIEW	2
2	FRONT + REAR	18
3	MIDDLE SECTION	10
4	CIRCLE + CIRCLE CONSTRUCTION + CL	6
TOTAL		36

PAPER 2 QUESTION 3
 GRADE 12
 November 2017
 MARKING GUIDELINES

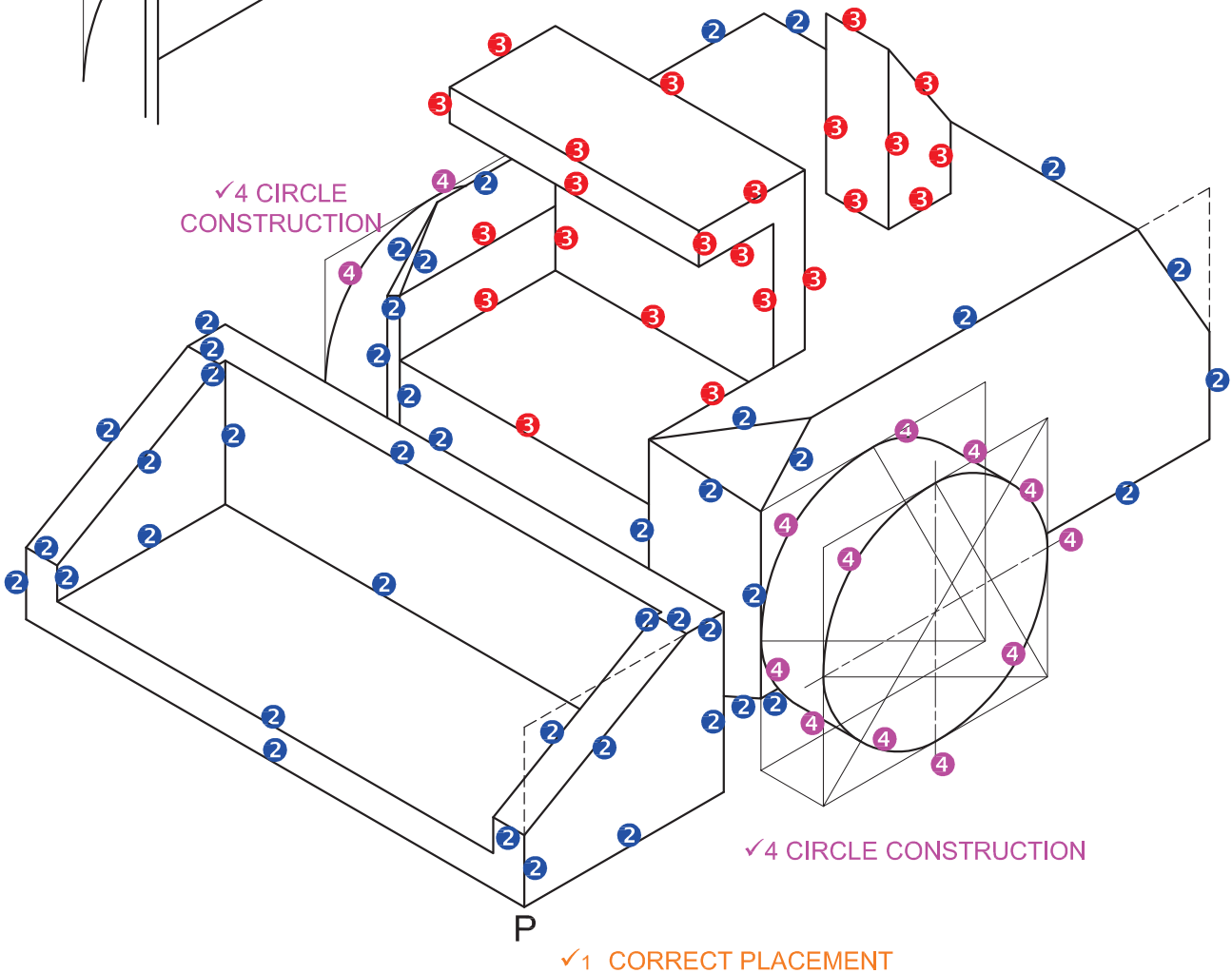
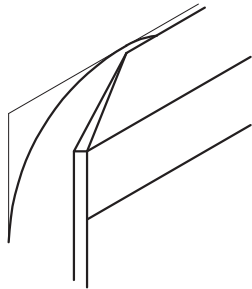
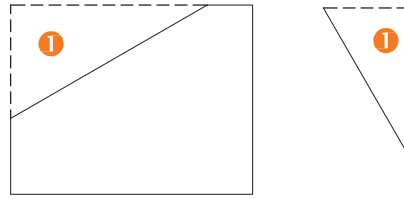

ASSESSMENT CRITERIA		
1	PLACEMENT + AUX VIEW	2
2	SCOOP + BODY	22
3	CABIN + EXHAUST	11 ¹ / ₂
4	CIRCLE + CIRCLE CONSTRUCTION + CL	8 ¹ / ₂
TOTAL		44

PAPER 2 QUESTION 3
 GRADE 12
 SCE 2017
 MARKING GUIDELINES

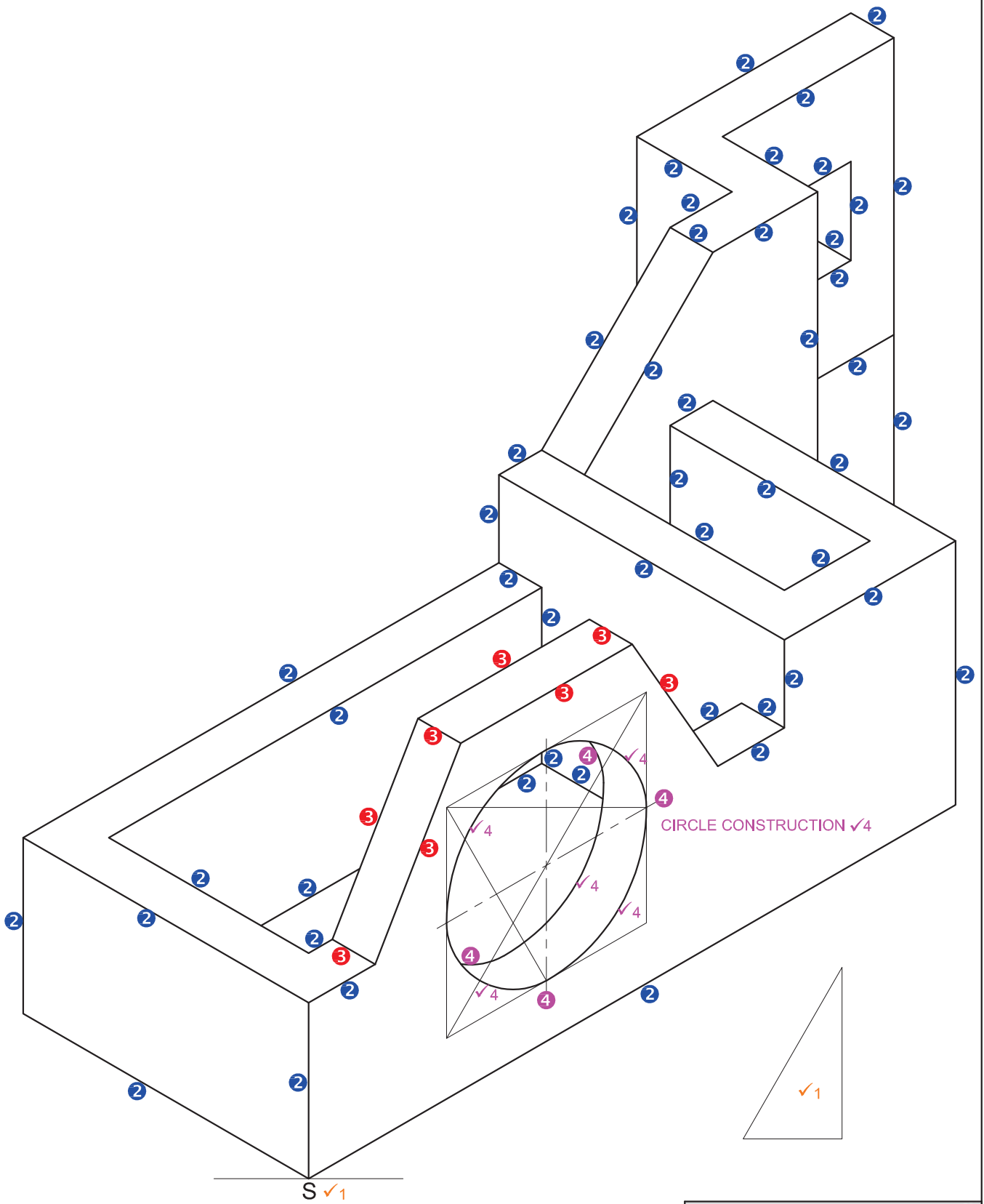

ASSESSMENT CRITERIA		
1	AUXILIARY VIEW + PLACEMENT	2
2	FRONT + REAR SECTION	25
3	HEXAGON	4
4	CIRCLE + CL	8
TOTAL		39

PAPER 2 QUESTION 3
 GRADE 12
 Feb./Mar. 2017
 MEMORANDUM

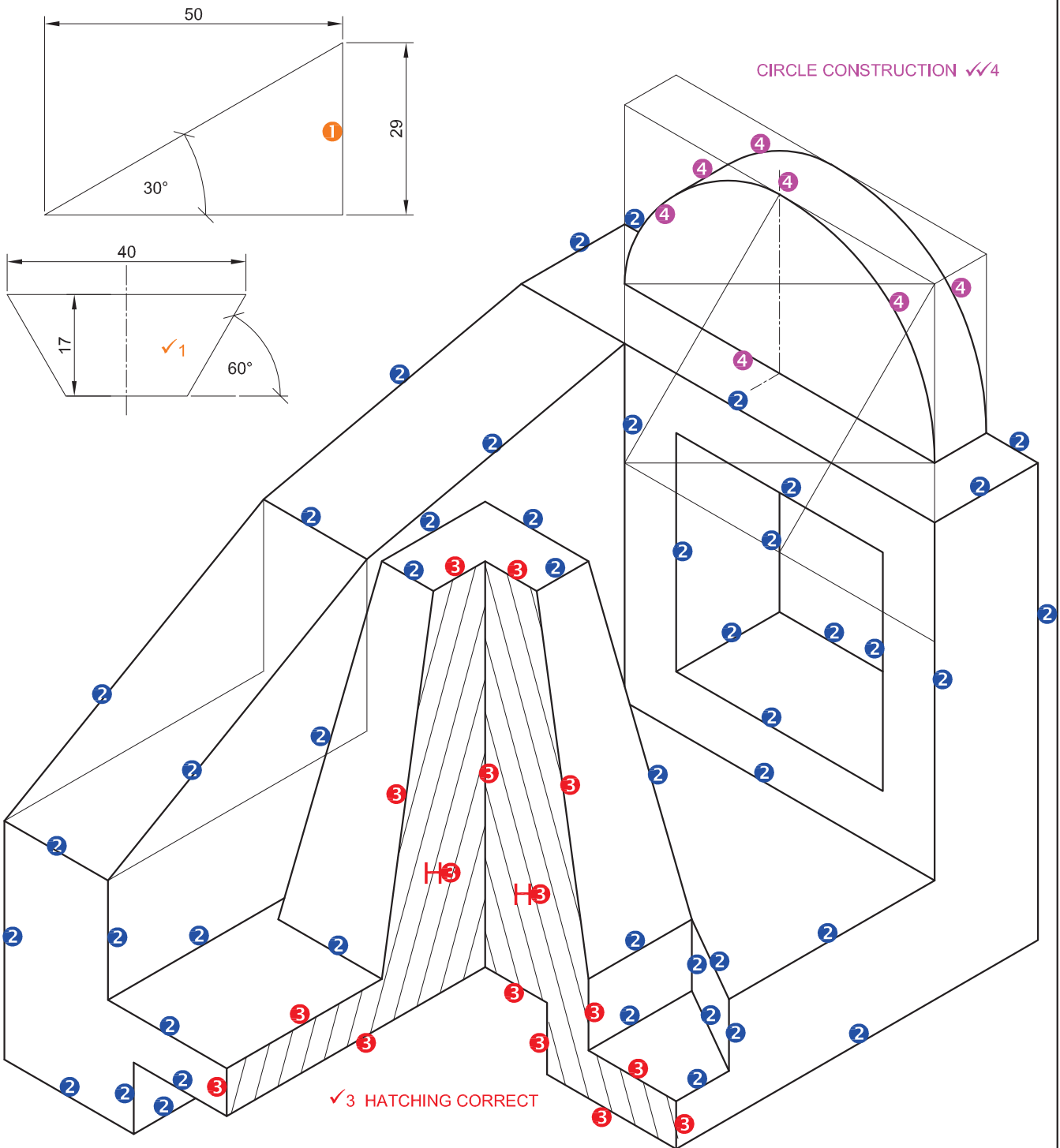

CIRCLE CONSTRUCTION ✓✓4

✓3 HATCHING CORRECT

✓1 PLACING ON S

ASSESSMENT CRITERIA		
1	AUX. VIEW + PLACING	2 ½
2	ISOMETRIC + NON-ISOMETRIC LINES	23
3	SECTIONED SURFACES	9
4	ISOMETRIC CIRCLES + CIRCLE CONSTR'	5 ½
TOTAL		40

PAPER 2 QUESTION 3
 GRADE 12
 November 2016
 MEMORANDUM

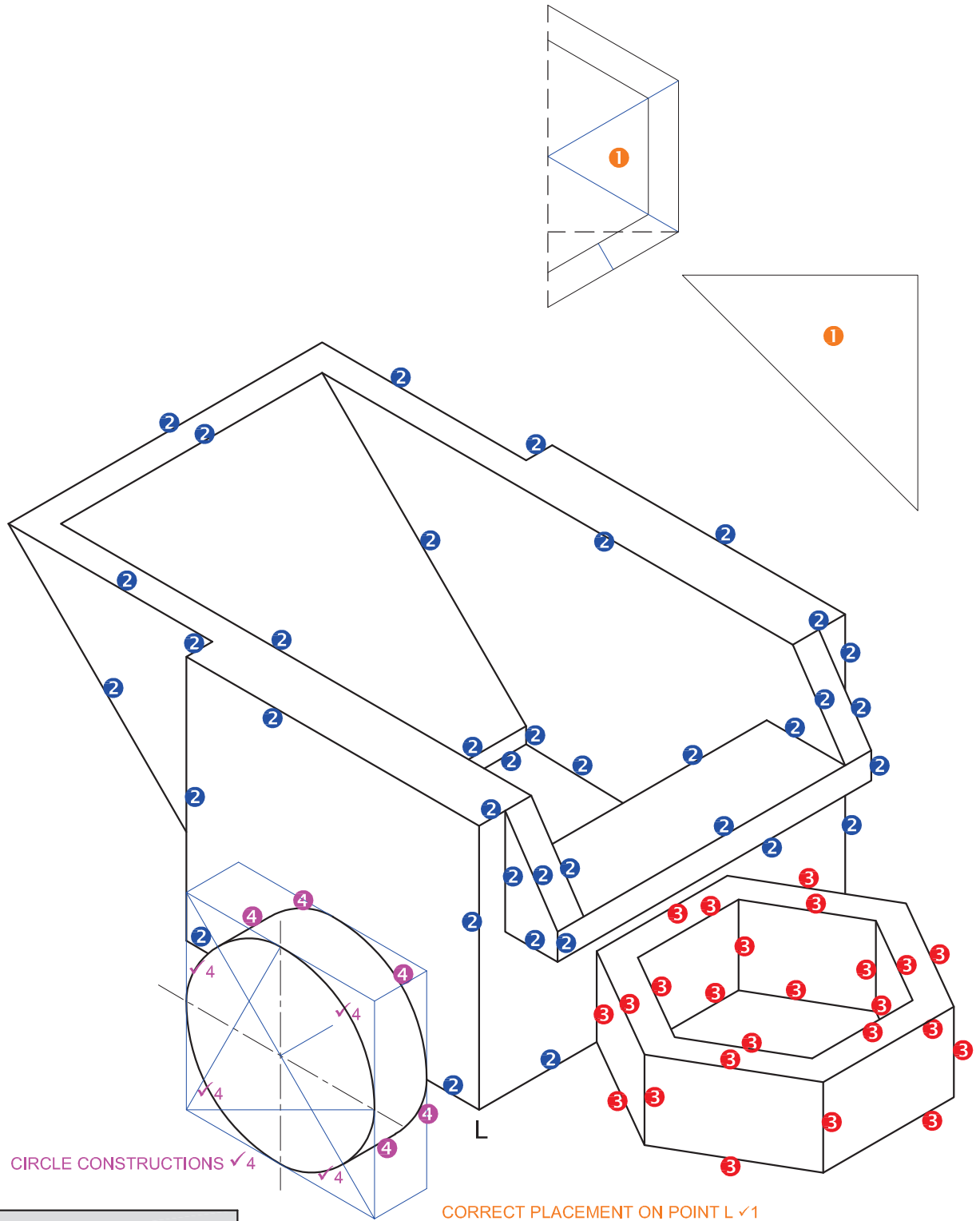

ASSESSMENT CRITERIA		
1	AUXILIARY VIEWS + PLACING	2
2	ISOMETRIC + NON-ISOMETRIC LINES	18½
3	HEXAGON	12
4	CIRCLES + CONSTRUCTION + CENTRE LINES	7½
PENALTIES (-)		
TOTAL		40

PAPER 2 QUESTION 3
 GRADE 12
 DBE/Feb.-Mar. 2016
 MEMORANDUM

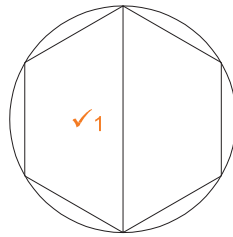
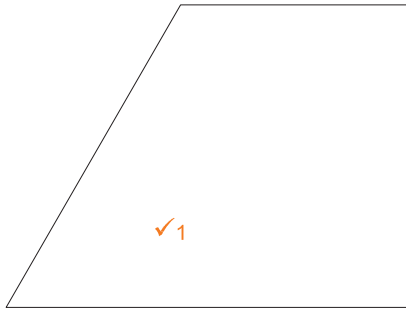

CIRCLE CONSTRUCTIONS ✓4

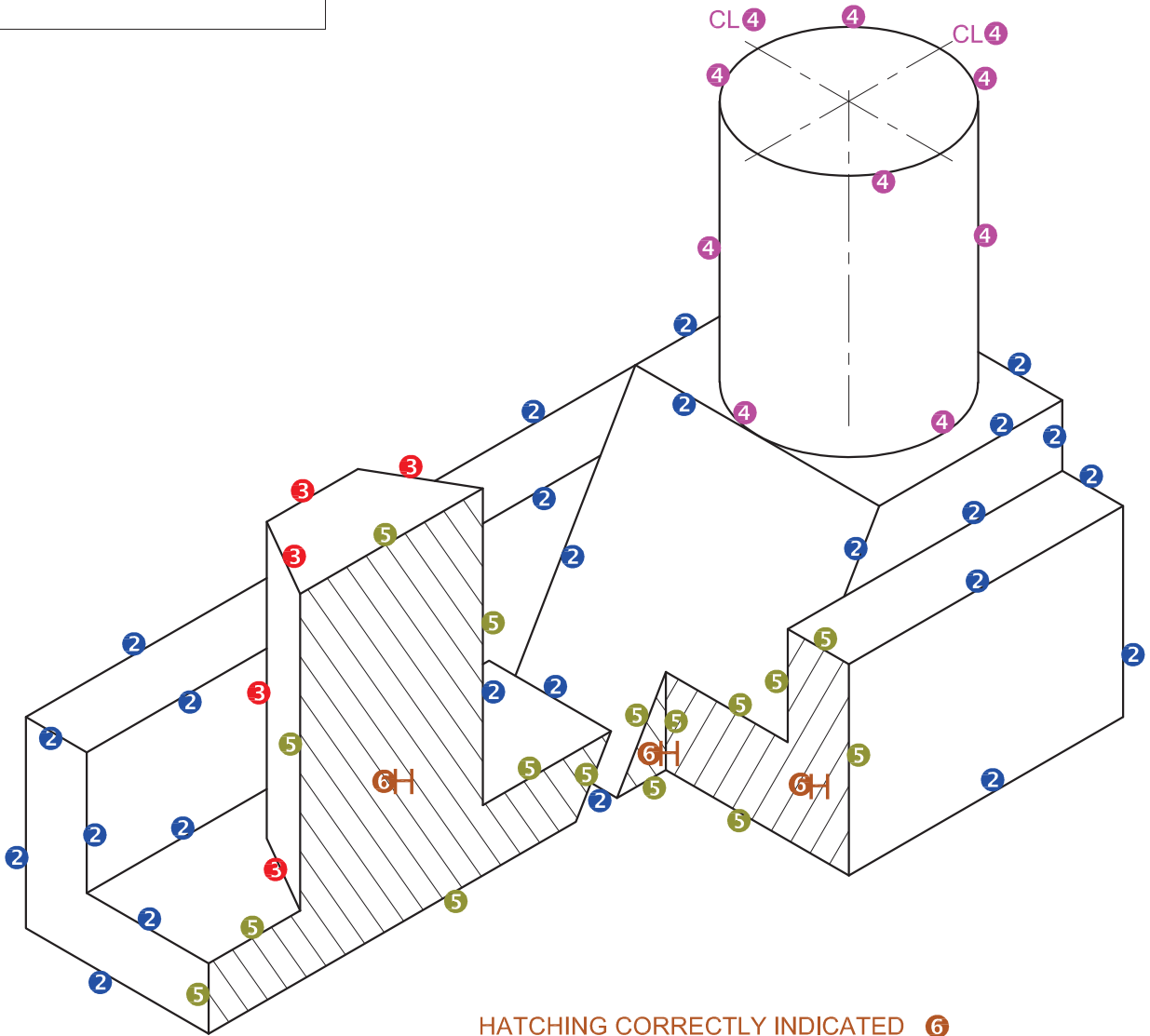

HATCHING CORRECTLY INDICATED 6



P CORRECT PLACEMENT ON POINT P ✓1

ASSESSMENT CRITERIA		
1	AUXILIARY VIEW + PLACING	3
2	ISOMETRIC + NON-ISOMETRIC	12 ½
3	HEXAGON	2 ½
4	CIRCLES + CONSTRUCTION + CL	6
5	SECTION	8
6	HATCHING	2
PENALTIES (-)		
TOTAL		34

PAPER 2 QUESTION 3
 GRADE 12
 November 2015
 MEMORANDUM



CIRCLE CONSTRUCTION ✓3✓3

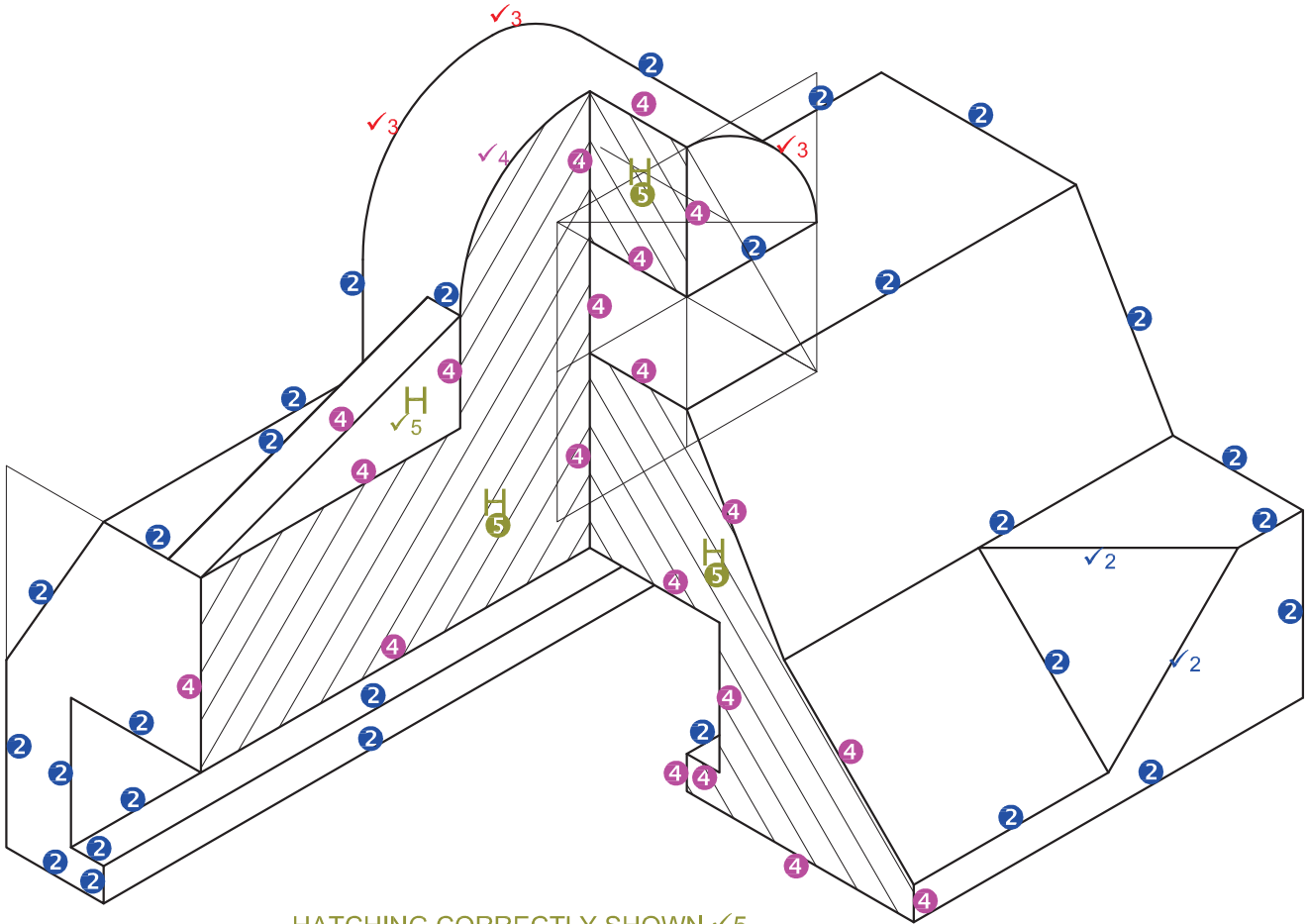

HATCHING CORRECTLY SHOWN ✓5

CORRECT PLACEMENT ON POINT P ✓1

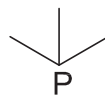

ASSESSMENT CRITERIA		
1	AUX. VIEW + PLACING	3
2	ISOMETRIC + NON-ISOMETRIC LINES	16½
3	ISOMETRIC CIRCLES + CIRCLE CONSTRUCTION.	5
4	SECTIONED SURFACES	11
5	HATCHING	3½
PENALTIES (-)		
TOTAL		39

PAPER 2 QUESTION 3
 GRADE 12
 Feb.-Mar. 2015
 MEMORANDUM

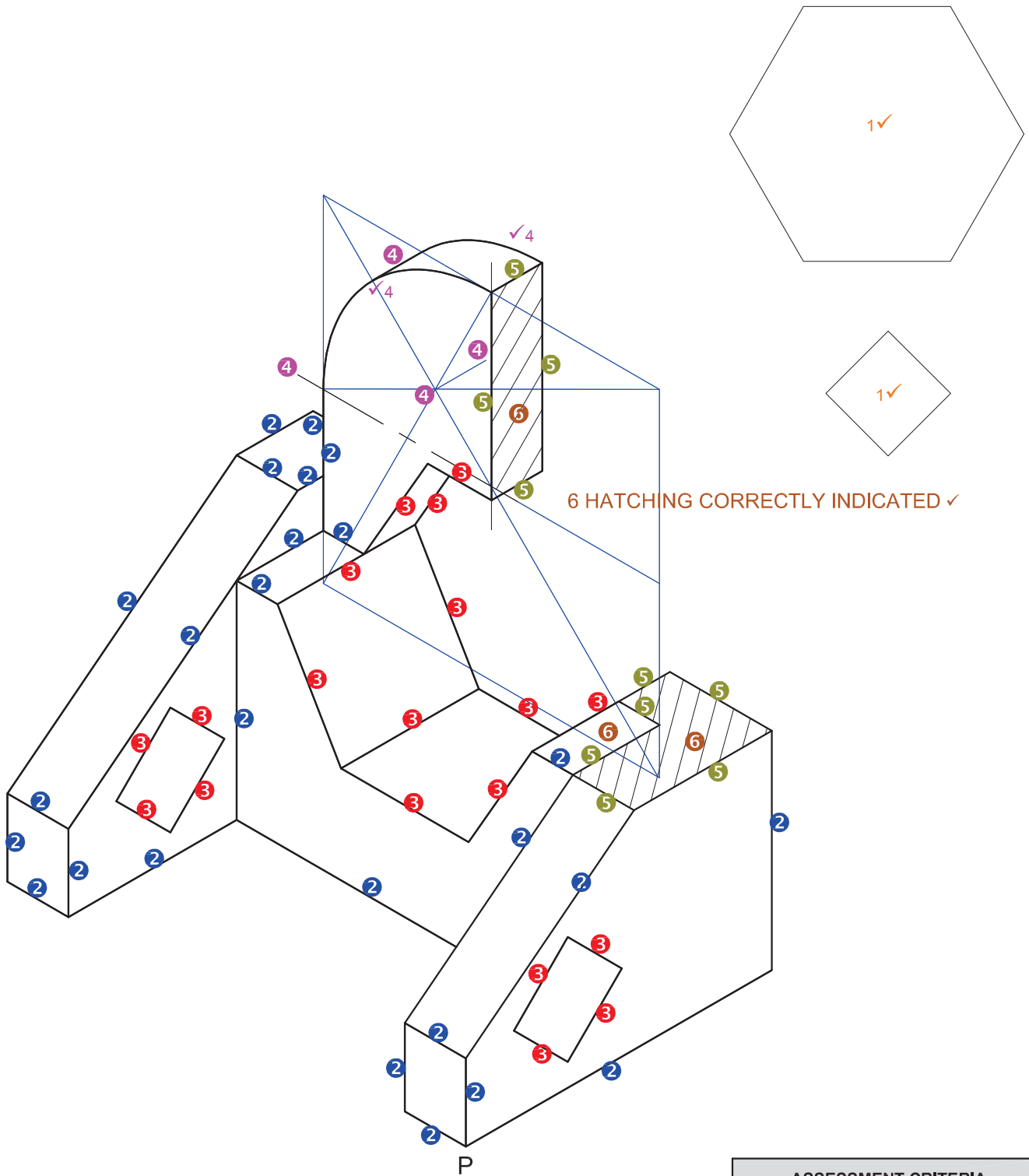

CORRECT PLACEMENT ON POINT P ✓

PAPER 2 QUESTION 3
 GRADE 12
 November 2014
 MEMORANDUM

ASSESSMENT CRITERIA		
1	AUX. VIEW + PLACING	3
2	ISOMETRIC + NON-ISO'	13
3	HEXAGON + SQUARES	9½
4	CIRCLES + CONST.	4
5	SECTION	5
6	HATCHING	2½
PENALTIES (-)		
TOTAL		37

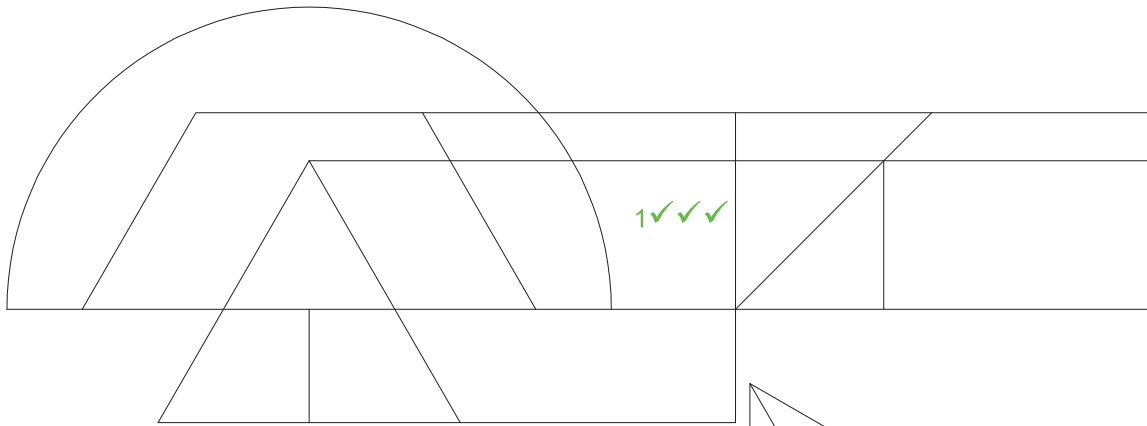

CIRCLE CONSTRUCTION 4✓✓

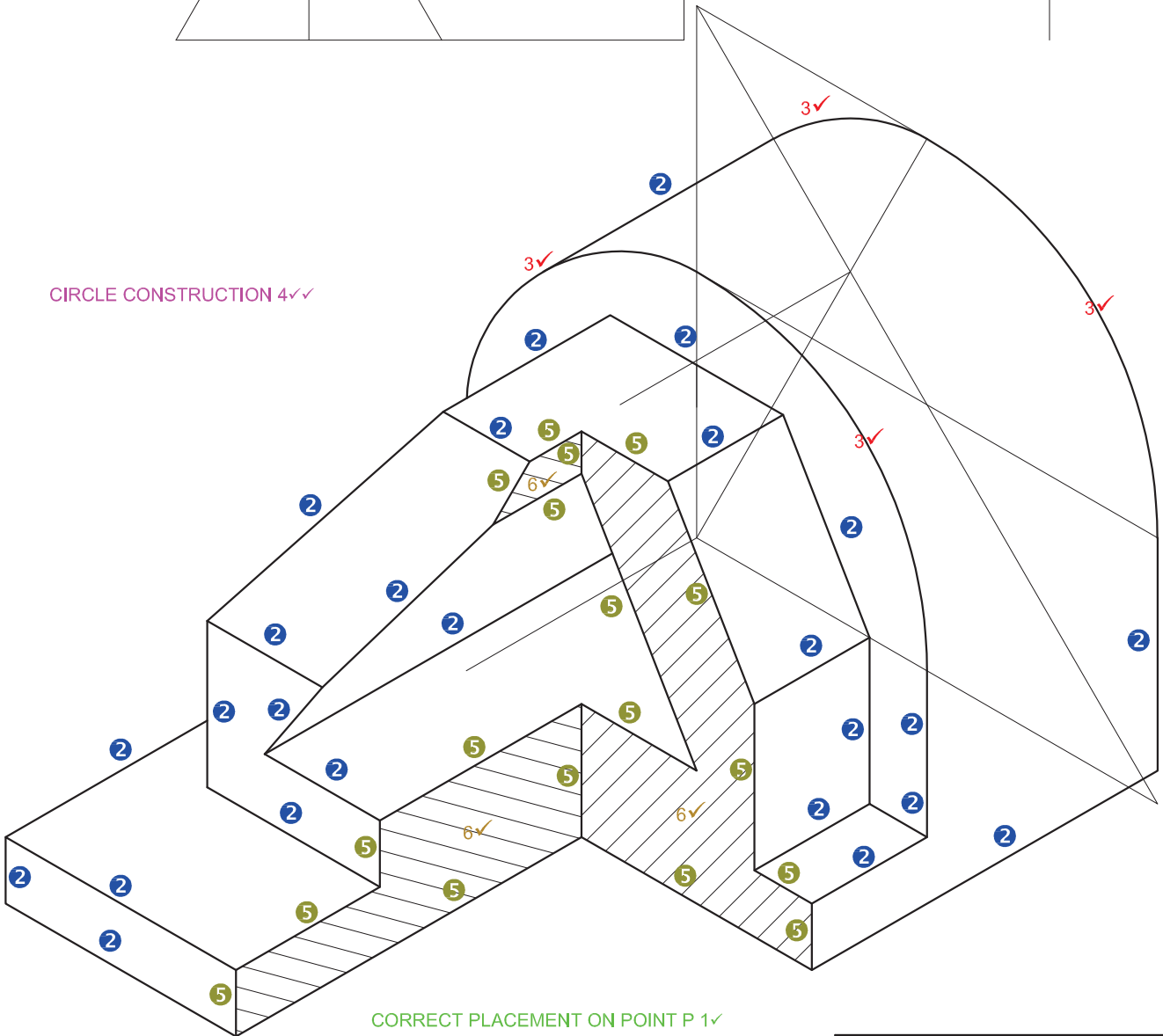

CORRECT PLACEMENT ON POINT P 1✓

HATCHING CORRECTLY SHOWN 6✓

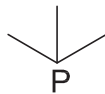

ASSESSMENT CRITERIA		
1.	AUX. VIEW + PLACING	4
2.	ISOMETRIC + NON-ISOMETRIC LINES	13
3.	ISOMETRIC CIRCLES	4
4.	CIRCLE CONSTRUCTION	2
5.	SECTIONED SURFACES	9
6.	HATCHING	4
TOTAL		36

PAPER 2 QUESTION 3
 GRADE 12
 EXEMPLAR 2014
 MEMORANDUM

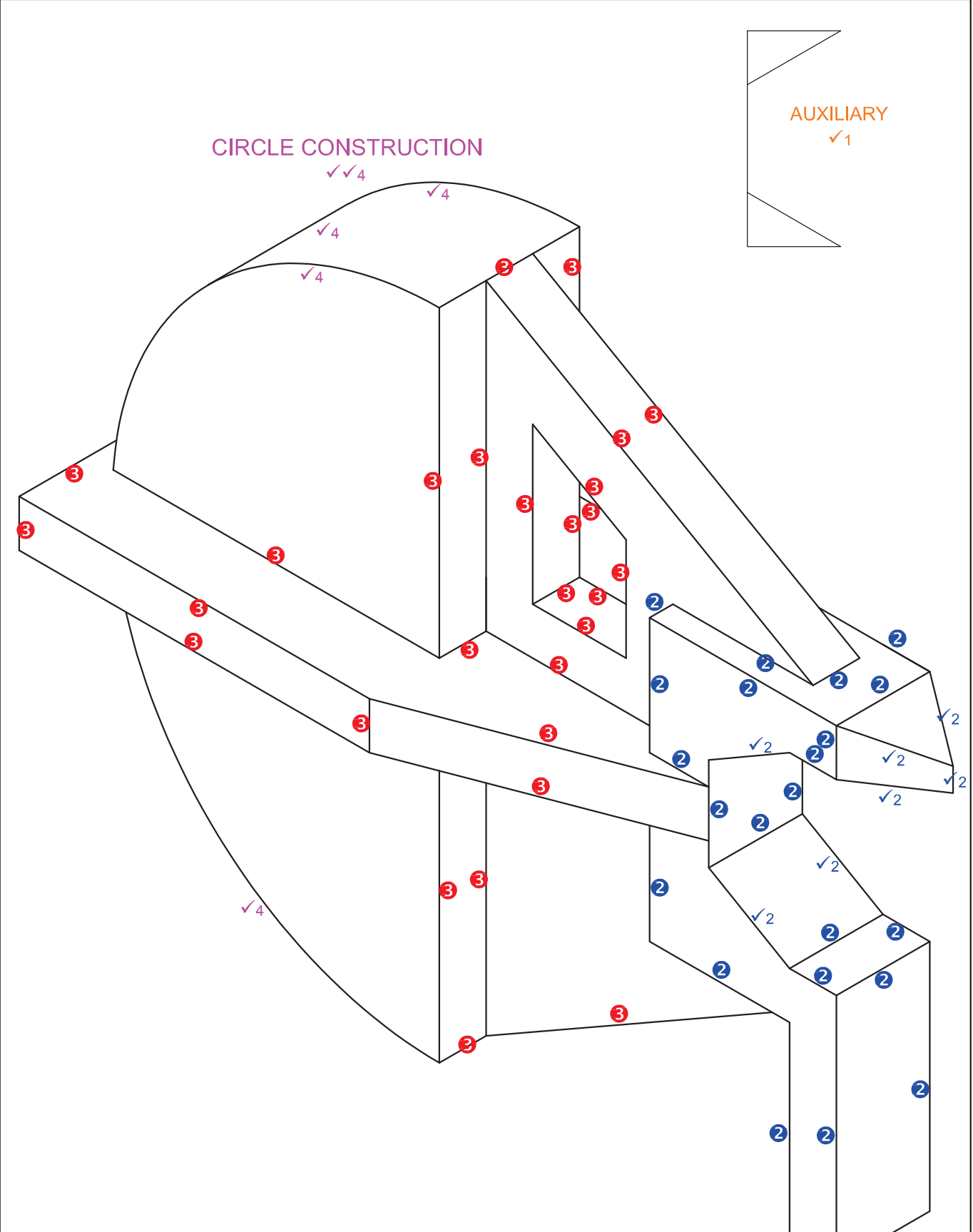

ASSESSMENT CRITERIA		
1	AUX. + PLACEMENT	2
2	FRONT	19
3	MIDDLE	14
4	CONSTR. + CIRCLE	6
TOTAL		41

PAPER 2 QUESTION 3
 GRADE 12
 FEB. - MAR. 2014
 MEMORANDUM

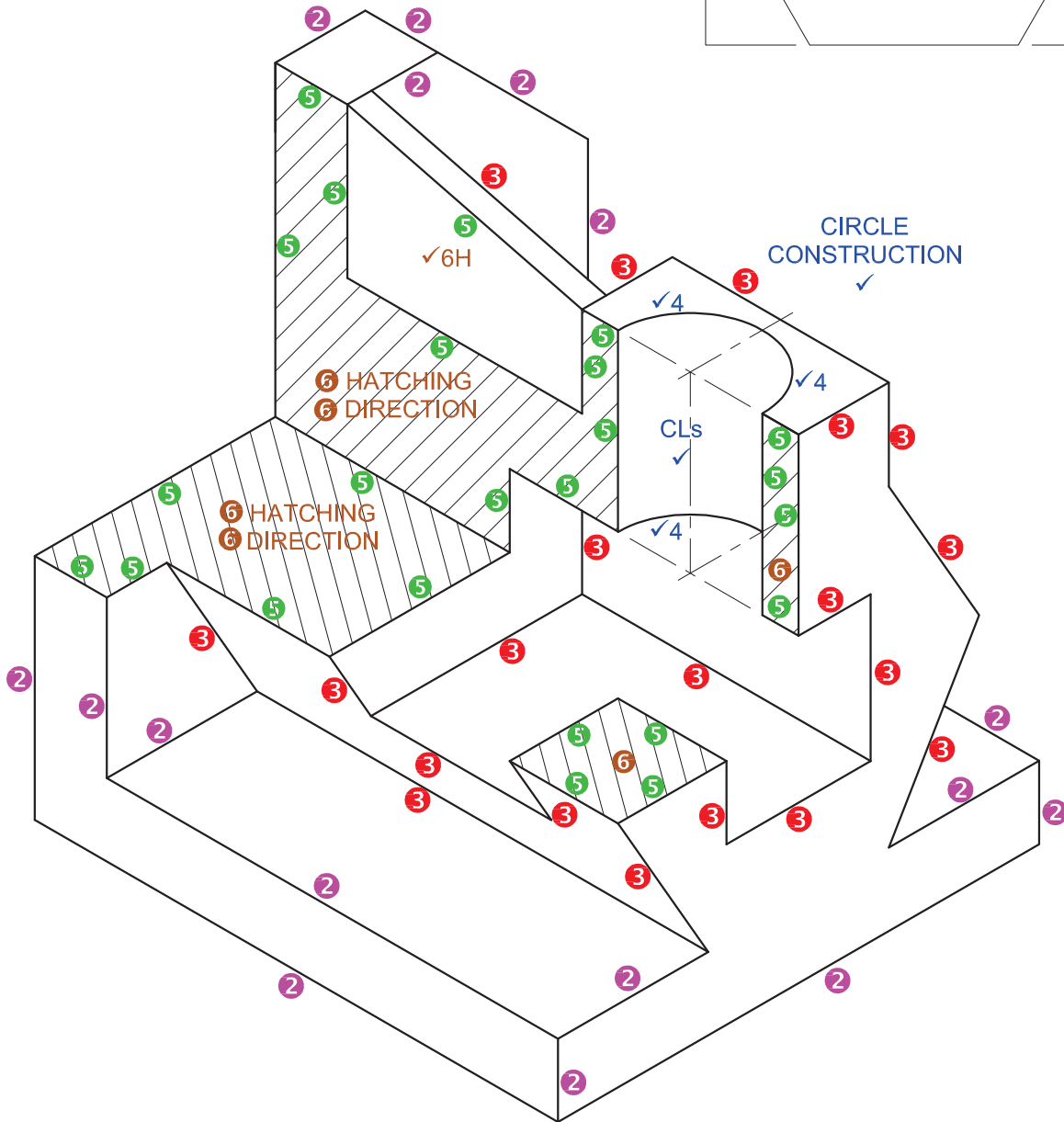
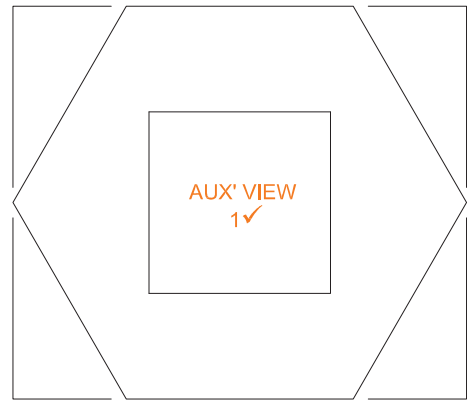

ASSESSMENT CRITERIA		
1	AUX' VIEW + PLACEMENT	2
2	BASE	8
3	HEXAGONAL PRISM	10
4	CIRCLES	5
5	SECTION	12
6	HATCHING	4
	TOTAL	41

PAPER 2 QUESTION 3
 GRADE 12
 November 2013
 MEMORANDUM

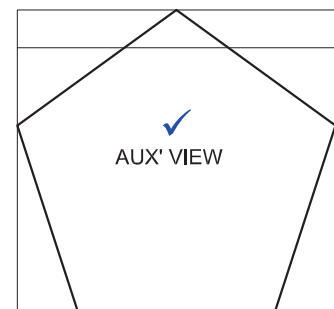
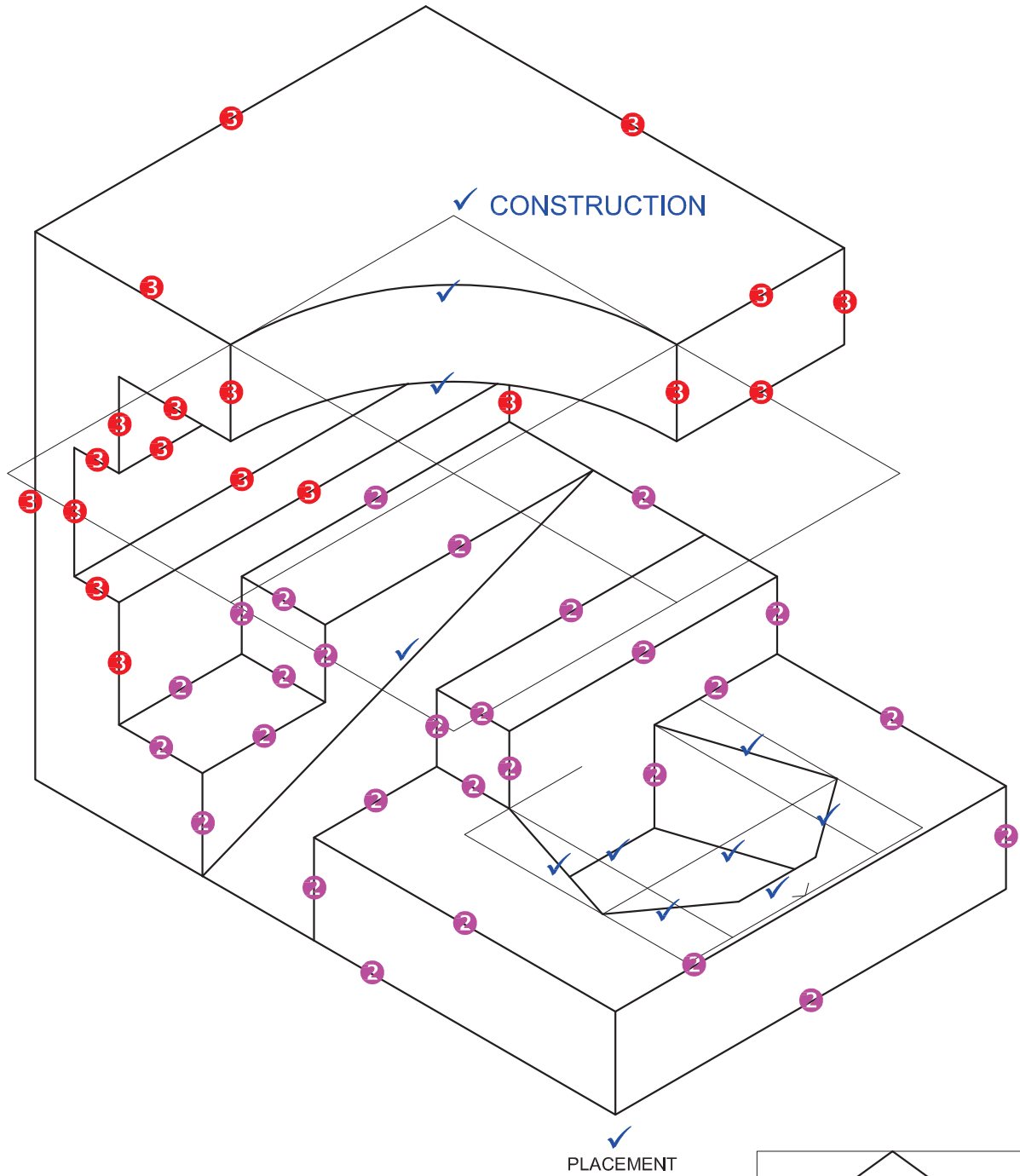

ASSESSMENT CRITERIA		
1	AUX' VIEWS + CIRCLE PENTAGON + PLACING	12
2	LOWER PORTION	15½
3	UPPER PORTION	9½
TOTAL		37

PAPER 2 QUESTION 3
 GRADE 12
 FEB. - MAR. 2013
 MEMORANDUM

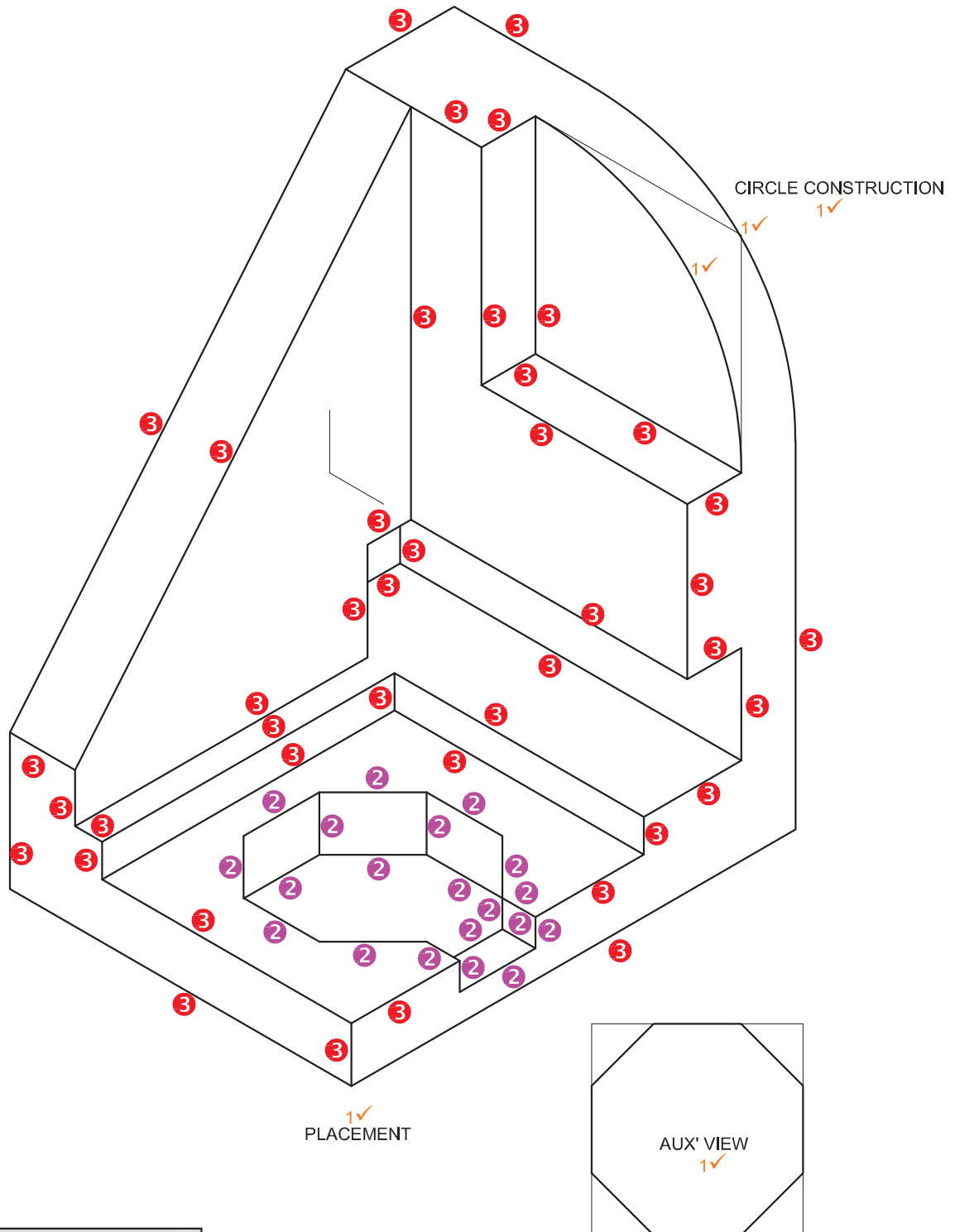

ASSESSMENT CRITERIA		
1	AUX' VIEWS + CIRCLE + CONSTR + PLACE	5
2	OCTAGONAL HOLE	10
3	ISO' + NON-ISO' LINES	21
TOTAL		36

PAPER 2 QUESTION 3
 GRADE 12
 NOVEMBER 2012
 MEMORANDUM

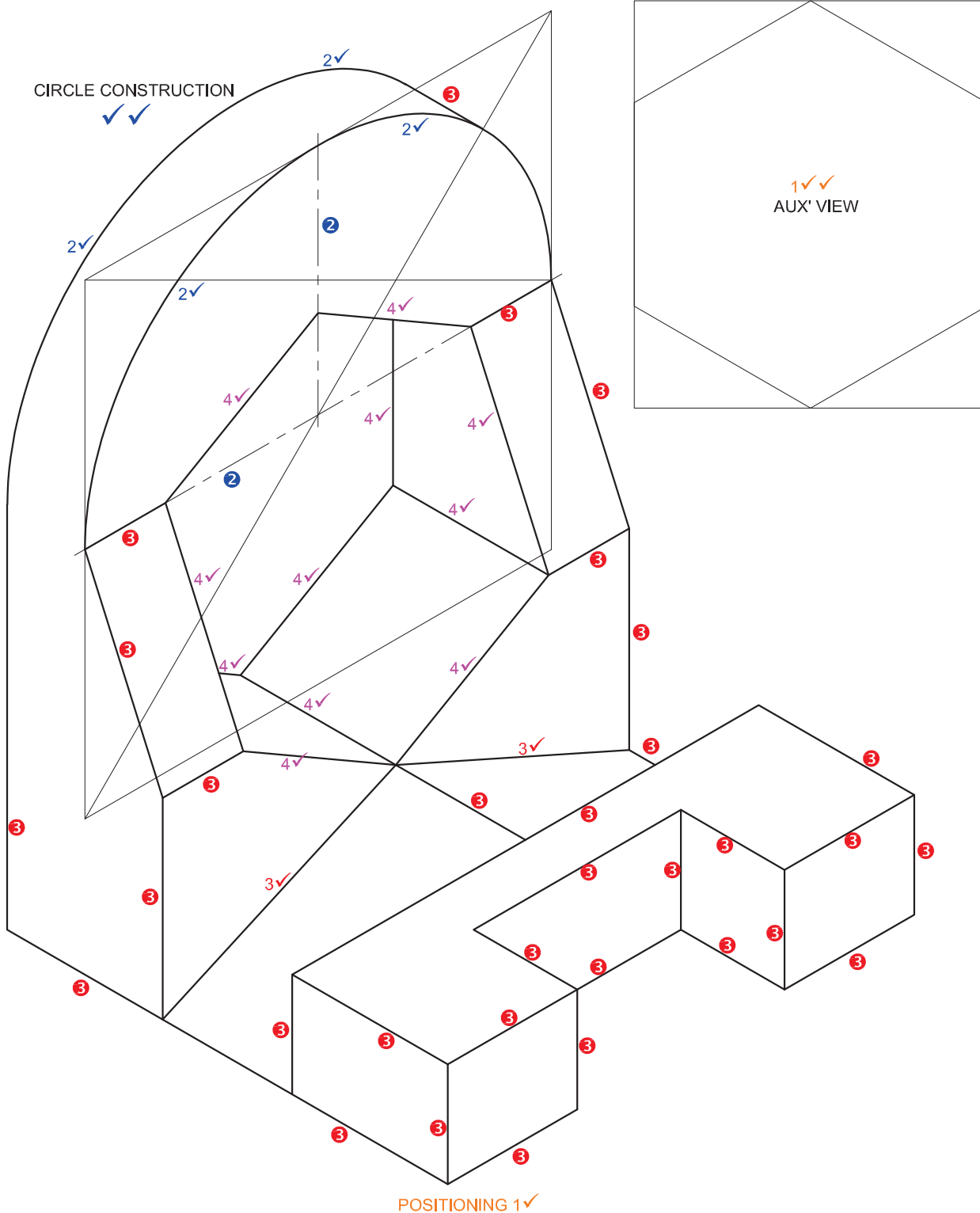

ASSESSMENT CRITERIA	
1. AUXILIARY VIEW + PLACEMENT + CIRCLE CONSTRUCTION	5
2. ISO' CIRCLES + CENTRE LINES	5
3. ISO + NON-ISO' LINES	18
4. HEXAGON	11
TOTAL	39

PAPER 2 QUESTION 3
 GRADE 12
 Feb.-Mar. 2012
 MEMORANDUM

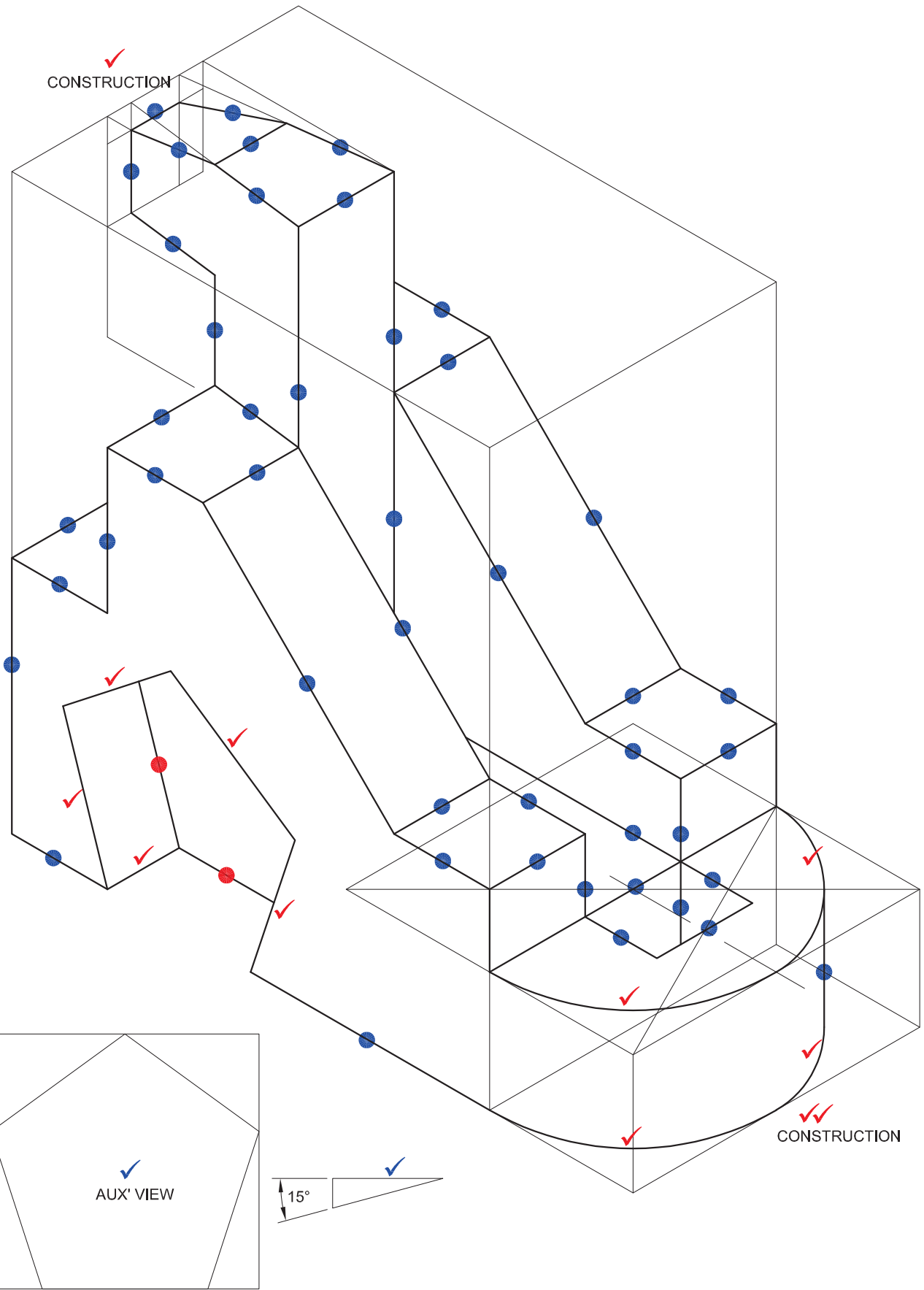

ASSESSMENT CRITERIA

AUXILIARY VIEW + CIRCLE CONST' PLACEMENT	6
ISO' ARCS + PENTAGONAL HOLE	11
ISO' AND NON-ISO' LINES	23
TOTAL	40

PAPER 2 QUESTION 3
 GRADE 12
 NOVEMBER
 MEMORANDUM

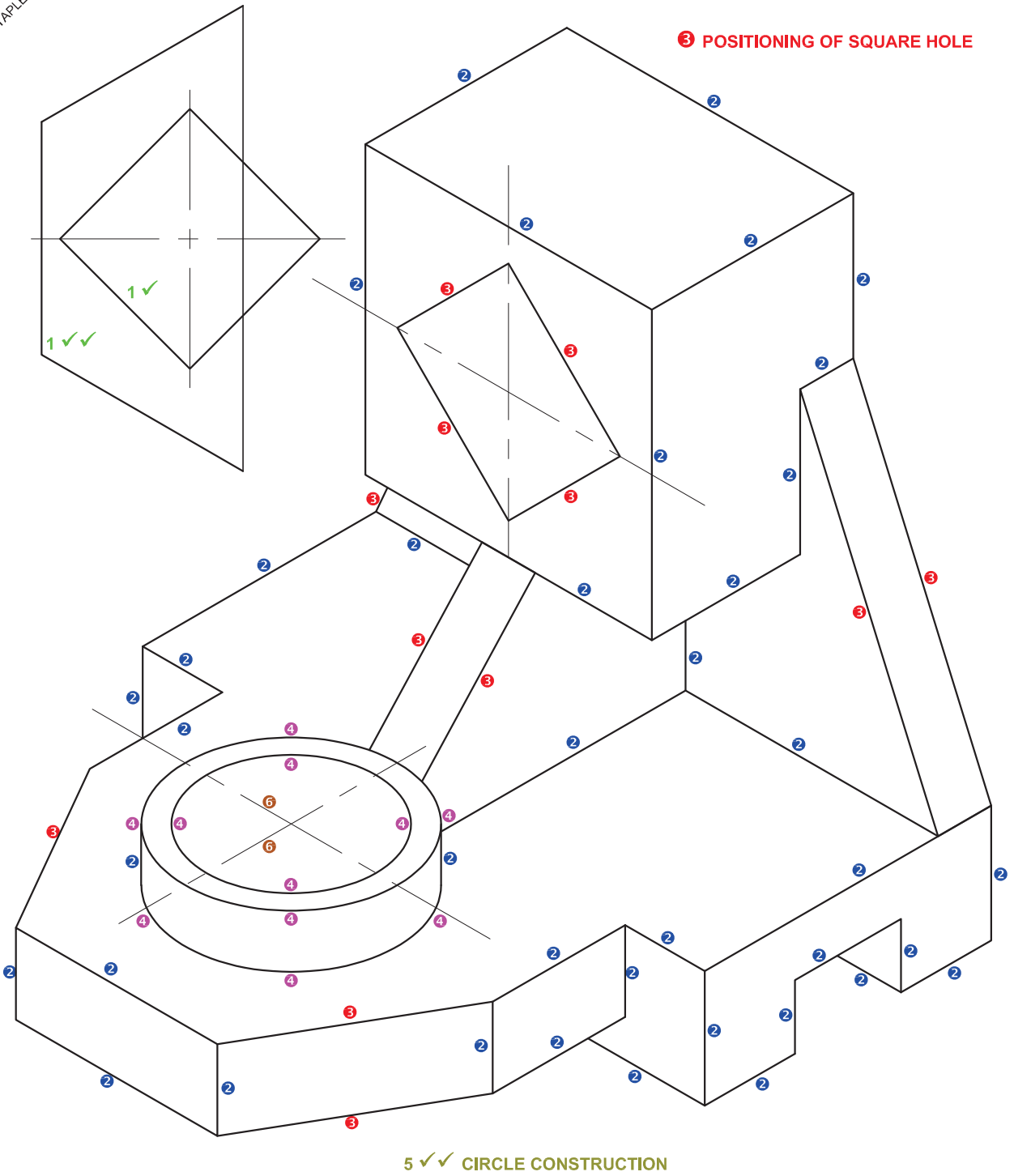

ASSESSMENT CRITERIA	
1. AUX. VIEW + PLACING	4
2. ISOMETRIC LINES	20
3. NON-ISOMETRIC LINES	6½
4. ISOMETRIC CIRCLES	5½
5. CIRCLE CONSTRUCTION	2
6. CENTRE LINES	1
TOTAL	39

A 1 ✓ FOR CORRECT ORIENTATION FROM A

PAPER 2 QUESTION 3
 GRADE 12
 FEBRUARY/MARCH 2011
 MEMORANDUM

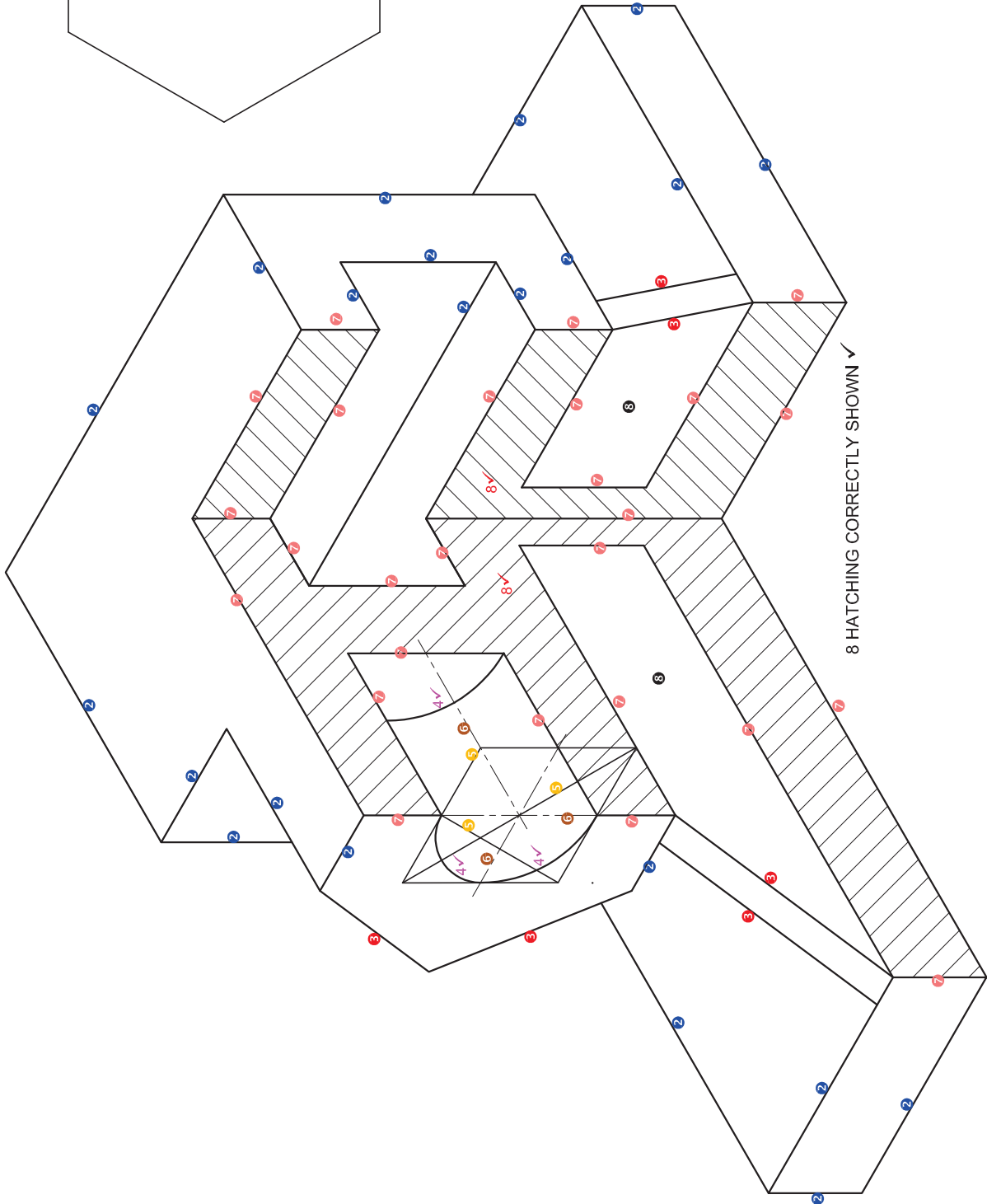
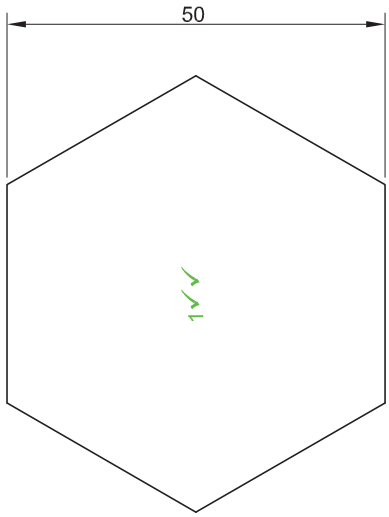

8 HATCHING CORRECTLY SHOWN ✓

1 CORRECT PLACEMENT ON POINT B ✓

ASSESSMENT CRITERIA	
1. AUX. VIEW + PLACING	3
2. ISOMETRIC LINES	11
3. NON-ISOMETRIC LINES	3
4. ISOMETRIC CIRCLES	3
5. CIRCLE CONSTRUCTION	1½
6. CENTRE LINES	1½
7. SECTIONED SURFACES	13
8. HATCHING	4
TOTAL	40

PAPER 2 QUESTION 3
 GRADE 12
 NOVEMBER 2010
 MEMORANDUM

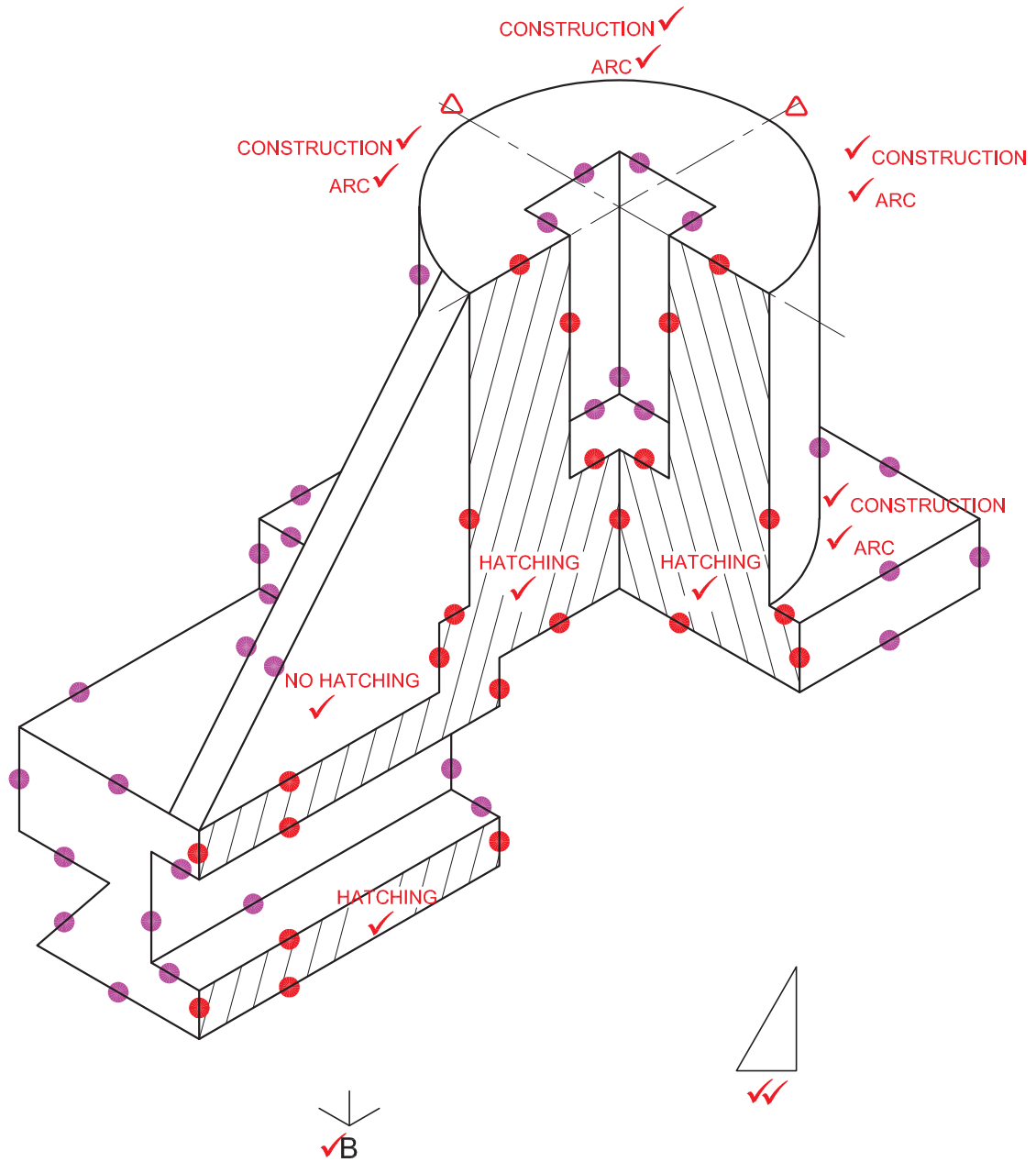

ASSESSMENT CRITERIA

AUXILIARY VIEW + PLACING	3
ISO' CIRCLES + CONSTR' + CENTRE LINES	9
ISO' + NON-ISO' LINES	15½
SECTIONED SURFACES	11½
HATCHING/NO HATCHING	4
TOTAL	43

PAPER 2 QUESTION 3
GRADE 12
FEBRUARY/MARCH 2010
MEMORANDUM

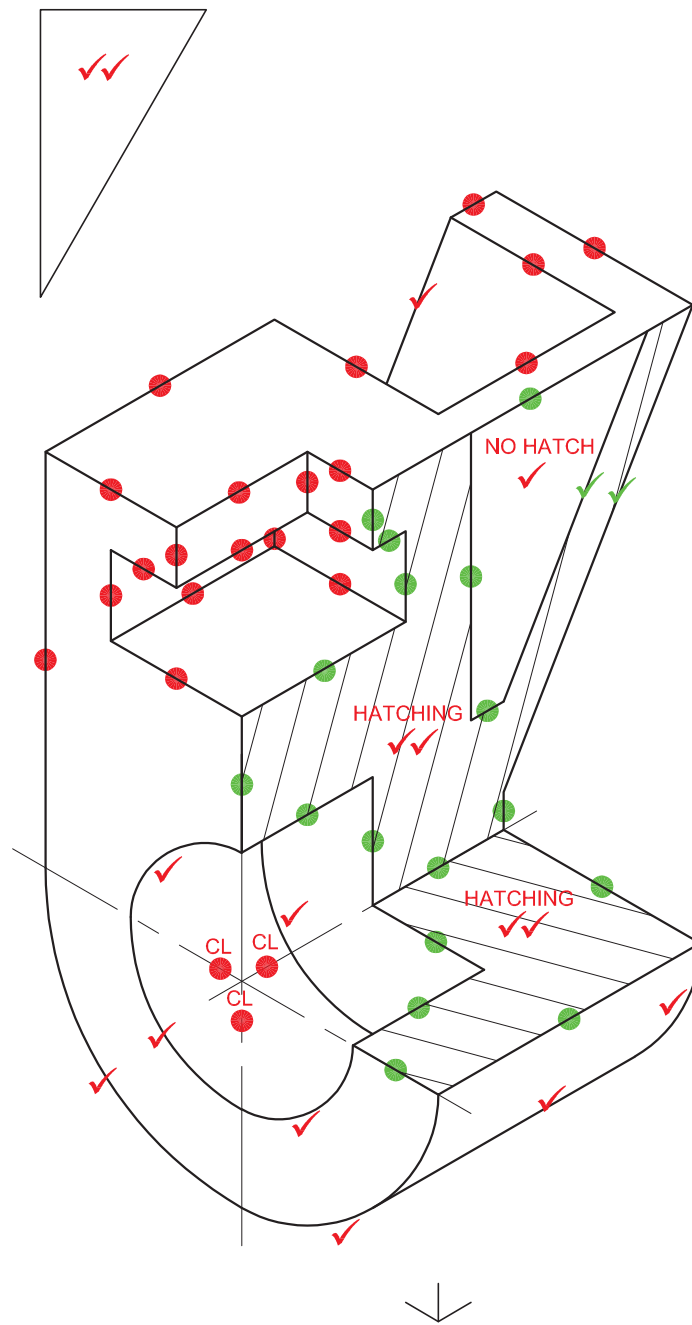

CIRCLE CONSTRUCTION 5

ASSESSMENT CRITERIA

CONSTRUCTION + AUXILIARY + B	= 8
ISO CIRCLES + CENTRE LINES	= 8½
ISO + NON-ISO LINES	= 12
SECTIONED SURFACES	= 10½
HATCHING	= 5
TOTAL	= 44

PAPER 2 QUESTION 3
GRADE 12 NOVEMBER 2009
MEMORANDUM

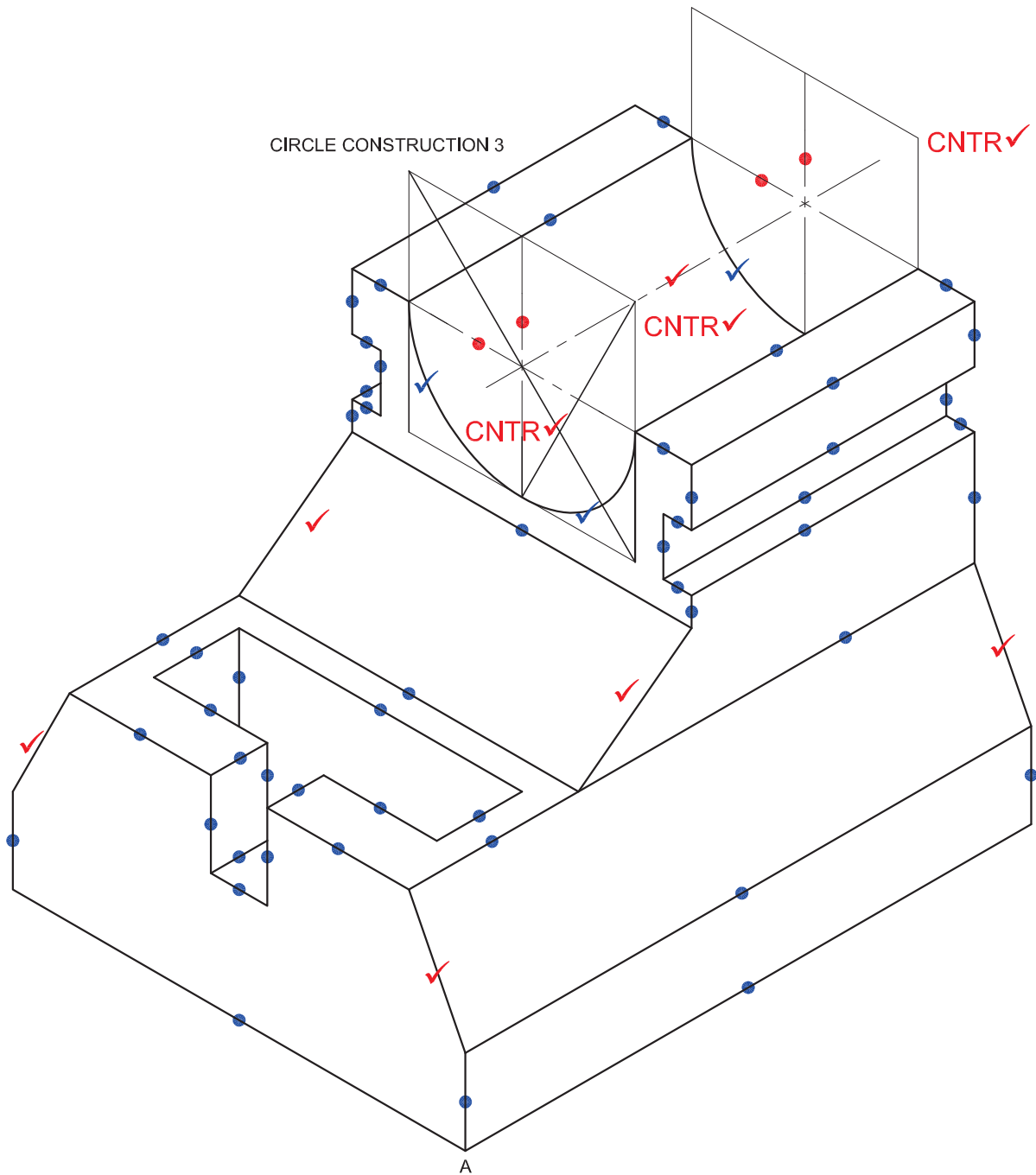

ASSESSMENT CRITERIA

AUXILIARY VIEW	=	2
ISOMETRIC LINES	=	26
NON-ISOMETRIC LINES	=	5
ISOMETRIC CIRCLES	=	3
CIRCLE CONSTRUCTION	=	3
CENTRE LINES	=	3
PLACING ON A	=	1
TOTAL	=	43

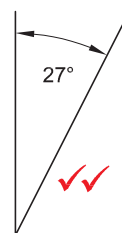

PAPER 2 QUESTION 3
 GRADE 12
 FEBRUARY/MARCH 2009
 MEMORANDUM

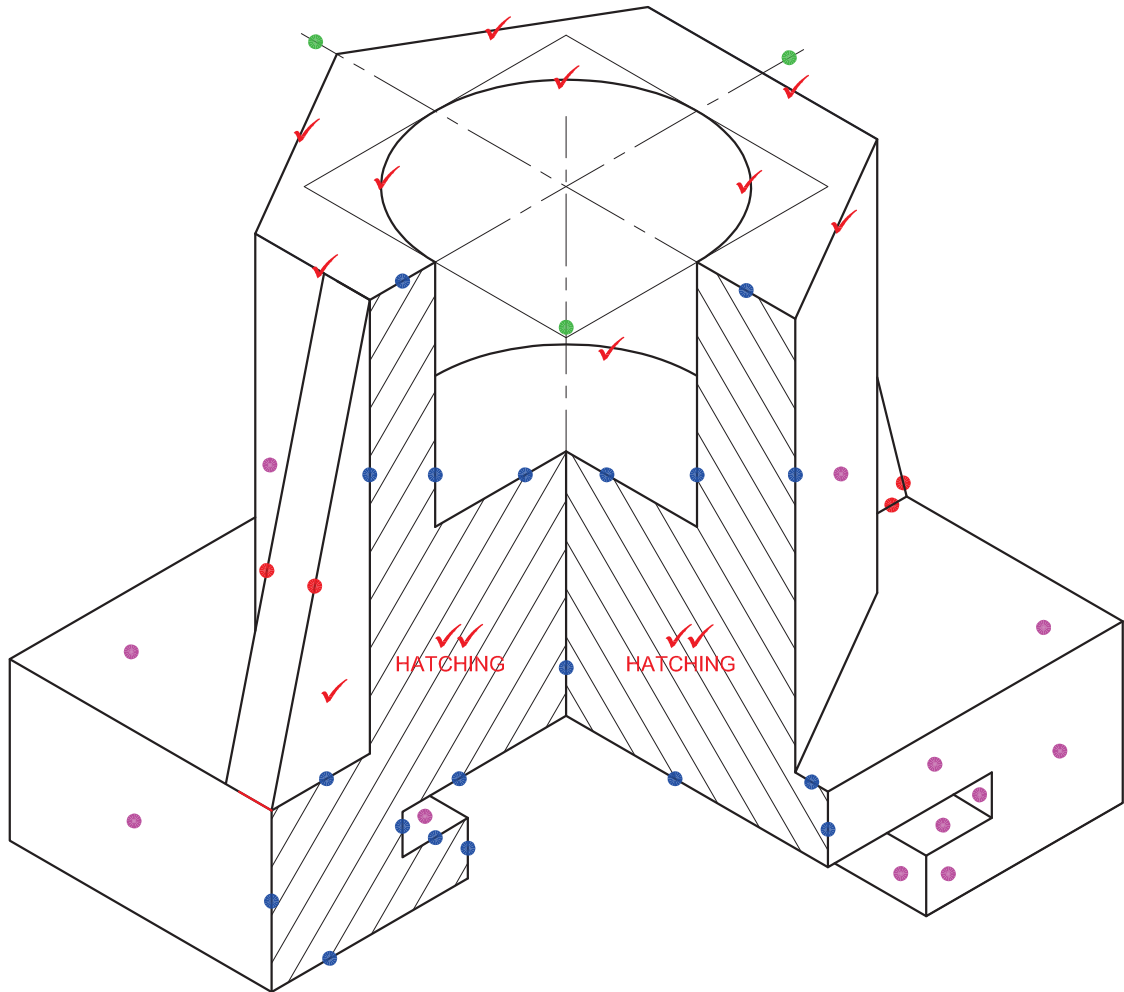
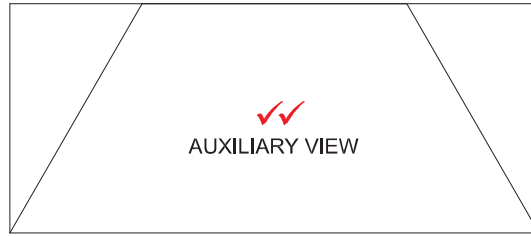

↓
A

ASSESSMENT CRITERIA	
AUXILIARY VIEW	= 2
ISOMETRIC SURFACES	= 6
NON-ISOMETRIC LINES	= 2
SECTIONED SURFACE	= 9½
ISOMETRIC CIRCLES	= 4
CIRCLE CONSTRUCTION	= 3
HATCHING	= 5
CENTRE LINES	= 1½
HEXAGON	= 5
PLACING ON A	= 2
TOTAL	= 40

QUESTION 3 PAPER 2
GRADE 12 NOVEMBER 2008
MEMORANDUM

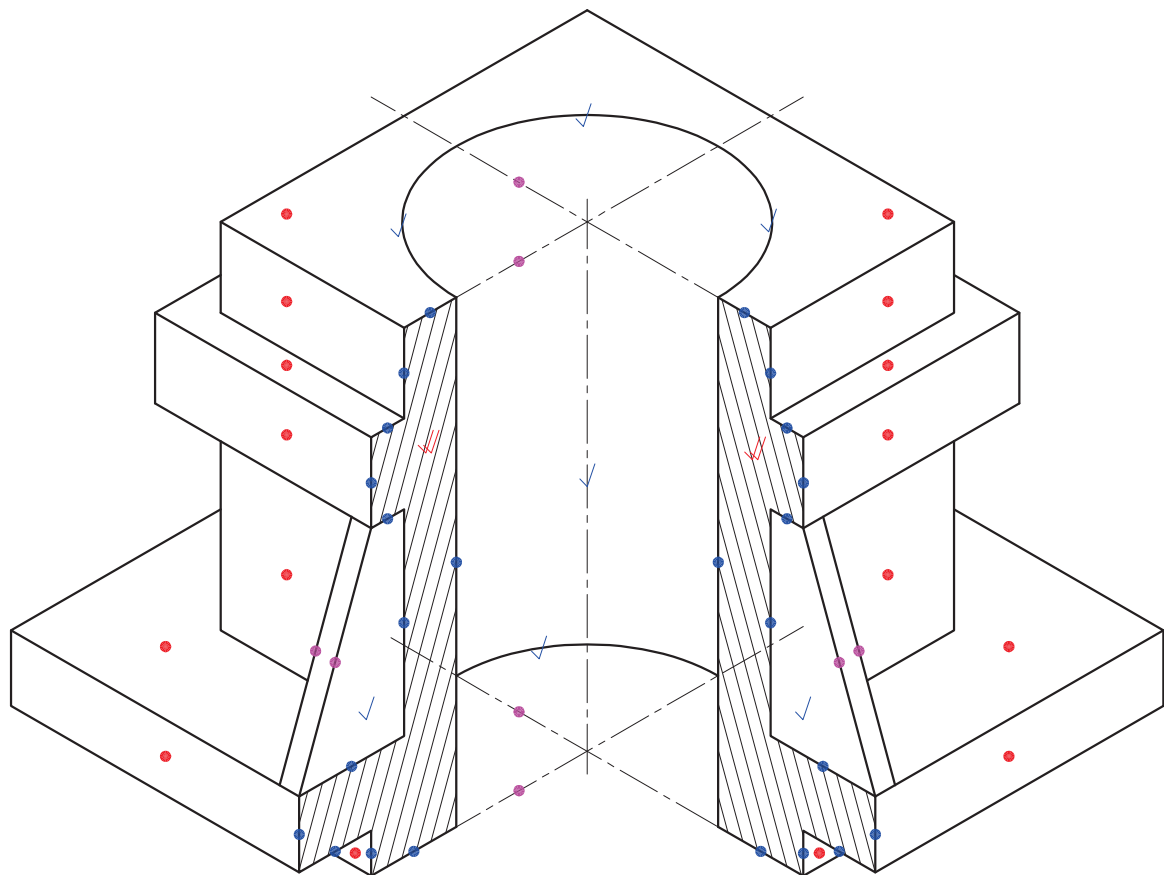
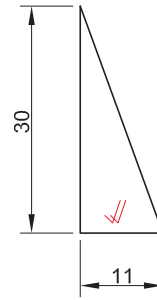

ASSESSMENT CRITERIA	
AUXILIARY VIEW	= 2
ISOMETRIC SURFACES	= 8
NON-ISOMETRIC LINES	= 2
SECTION	= 12
ISOMETRIC CIRCLES	= 4
CIRCLE CONSTRUCTION	= 4
HATCHING	= 6
CENTRE LINES	= 2
TOTAL	= 40

2008 GRADE 12
 PAPER 2
 EXEMPLAR
 QUESTION 3
 MEMORANDUM