

ASSESSMENT CRITERIA

1	CONSTRUCTION	6
2	FLOOR	11
3	WALLS	8½
4	ROOF	4½
5	WINDOWS + ARC	10
TOTAL		40

PAPER 1 QUESTION 3
 GRADE 12
 NOVEMBER 2023
 MARKING GUIDELINES

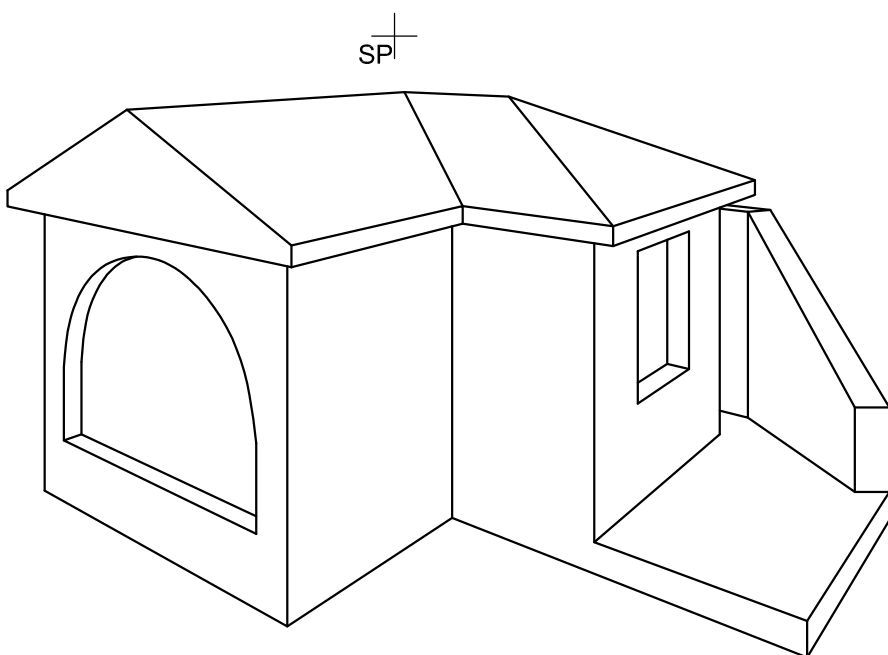
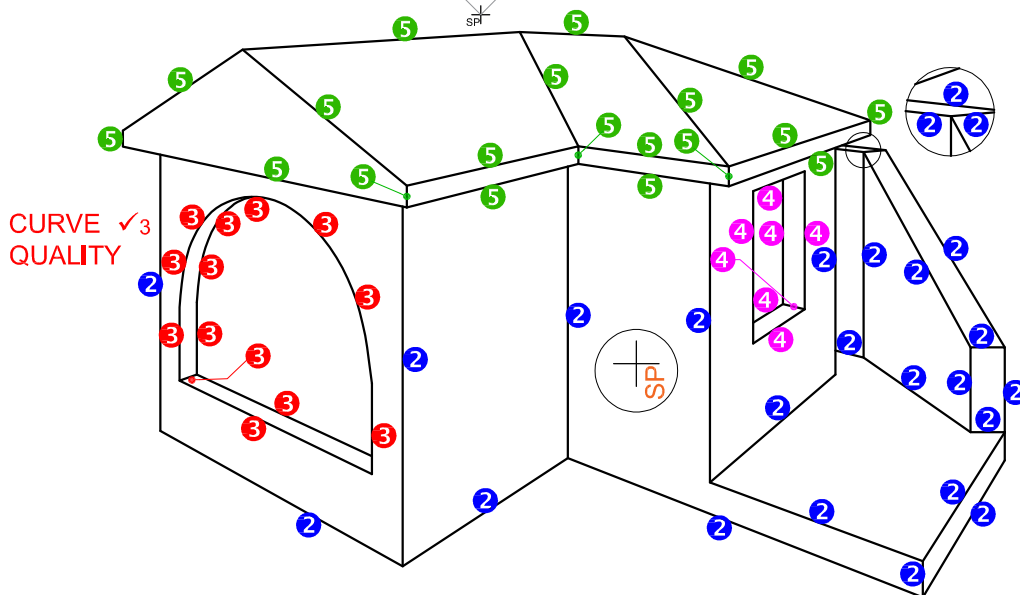
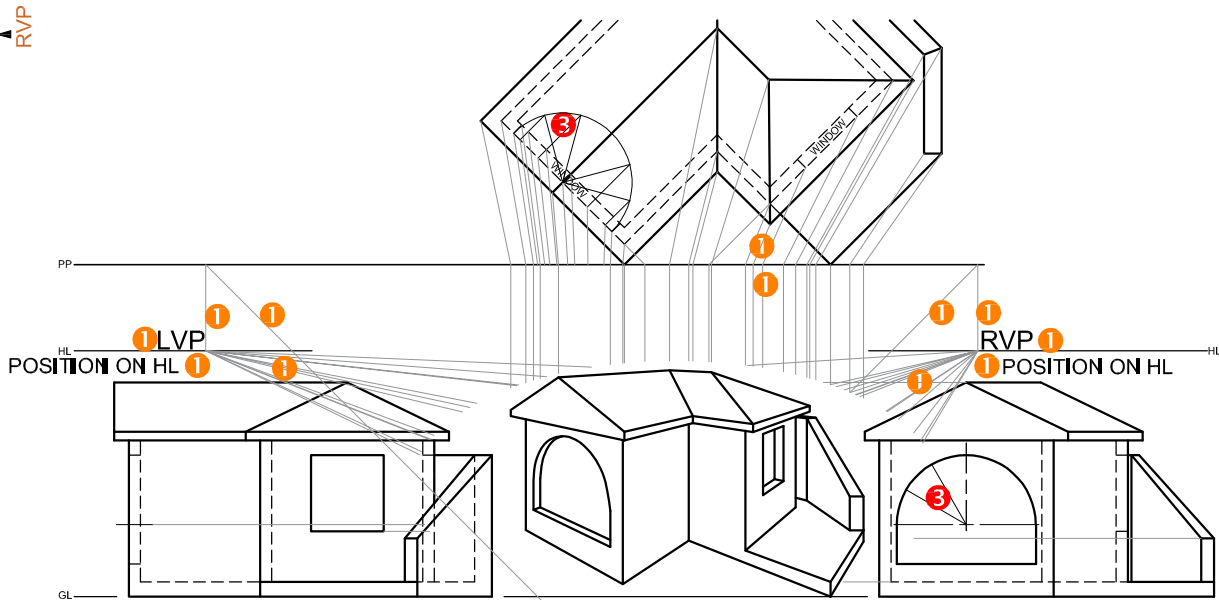

ASSESSMENT CRITERIA		
1	CONSTRUCTION	6
2	STOEP + WALLS	12 1/2
3	ARCH + CONSTR	8 1/2
4	WINDOW	3 1/2
5	ROOF	9 1/2
TOTAL		40

PAPER 1 QUESTION 3
 GRADE 12
 2023
 MARKING GUIDELINES

RVP

PP

HL

GL

RVP

HL

SP

SP

LVP

ASSESSMENT CRITERIA

	CONSTRUCTION	
1	CONSTRUCTION	6
2	WALL + BASE	10 1/2
3	WINDOWS + OPENING	10
4	ROOF	7 1/2
5	ARC	7
TOTAL		41

PAPER 1 QUESTION 3
GRADE 12
NOVEMBER 2022
MARKING GUIDELINES

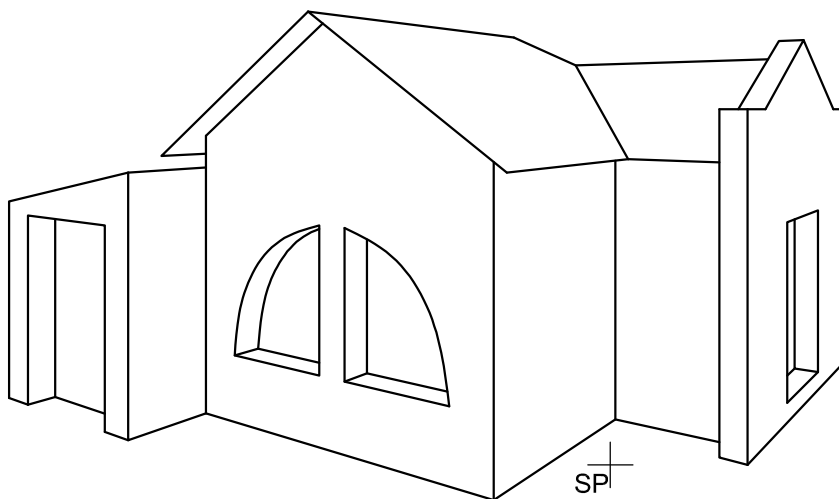
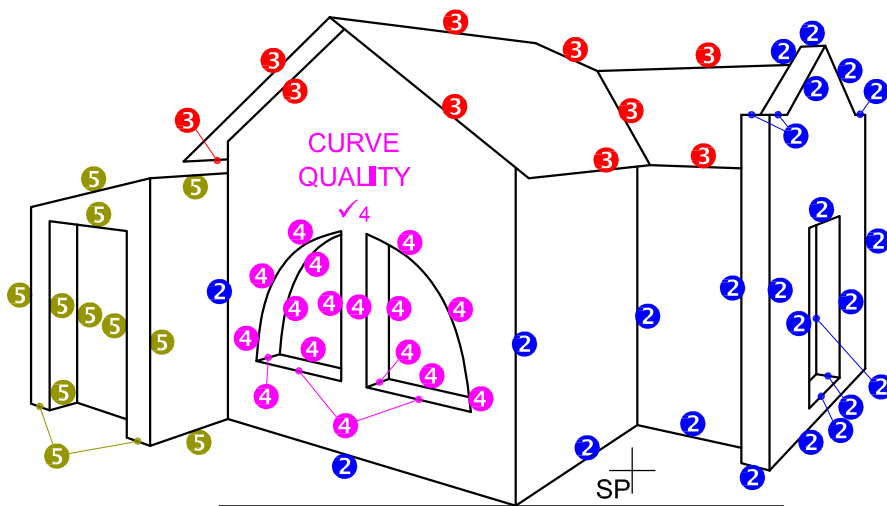
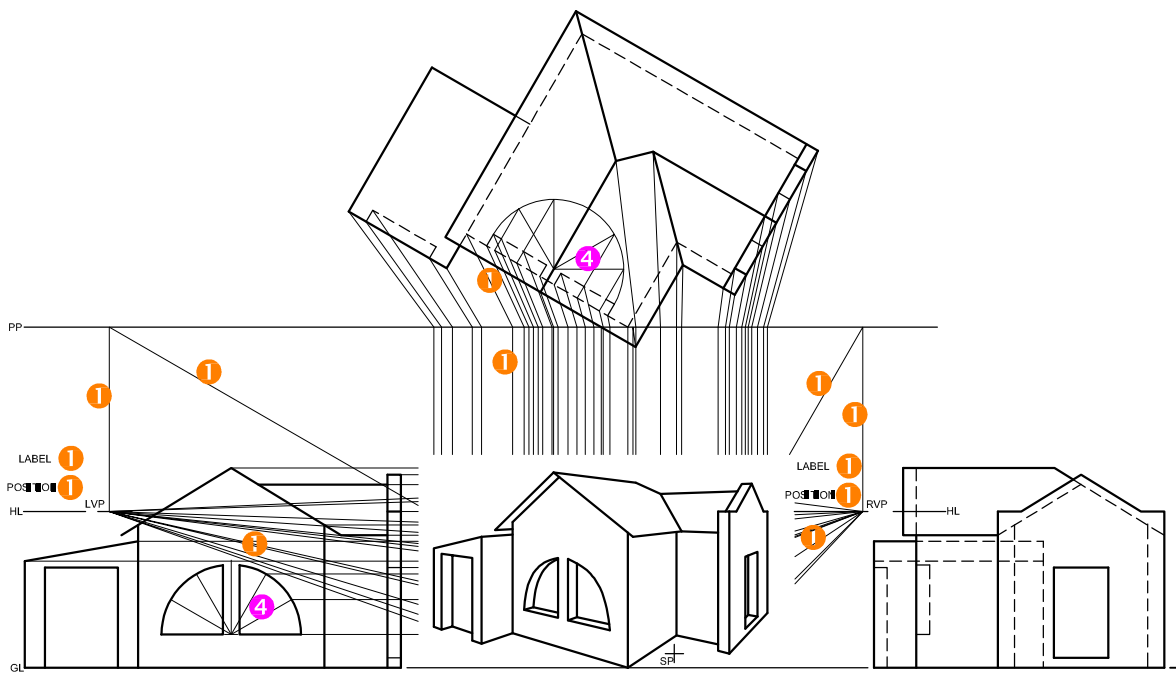

ASSESSMENT CRITERIA		
1	CONSTRUCTION	6
2	WALLS	11 1/2
3	ROOF	5
4	WINDOWS	10
5	GARAGE	5 1/2
TOTAL		38

PAPER 1 QUESTION 3
 GRADE 12
 2022
 MARKING GUIDELINES

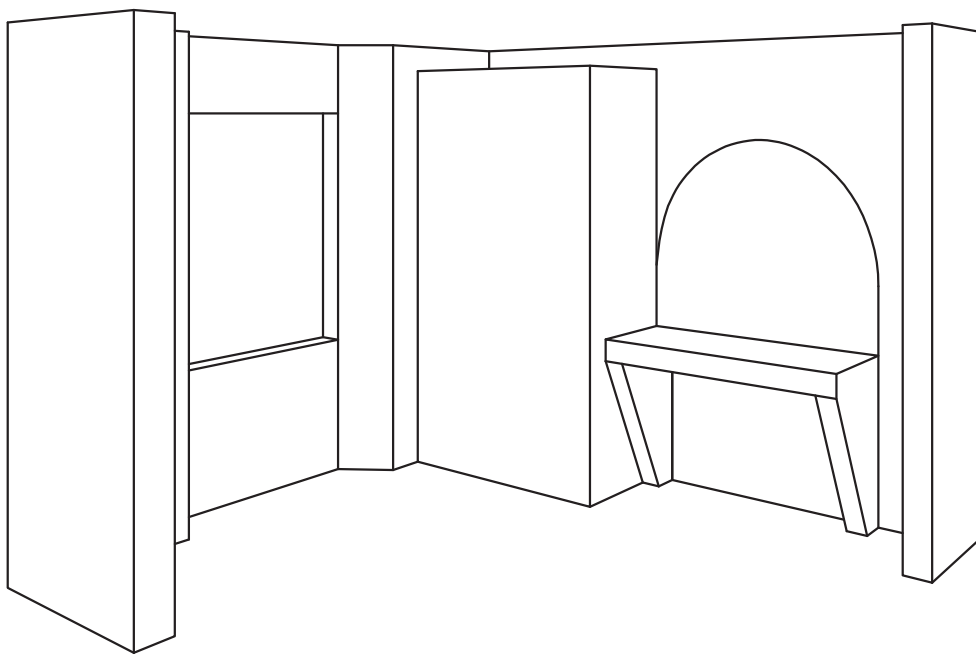
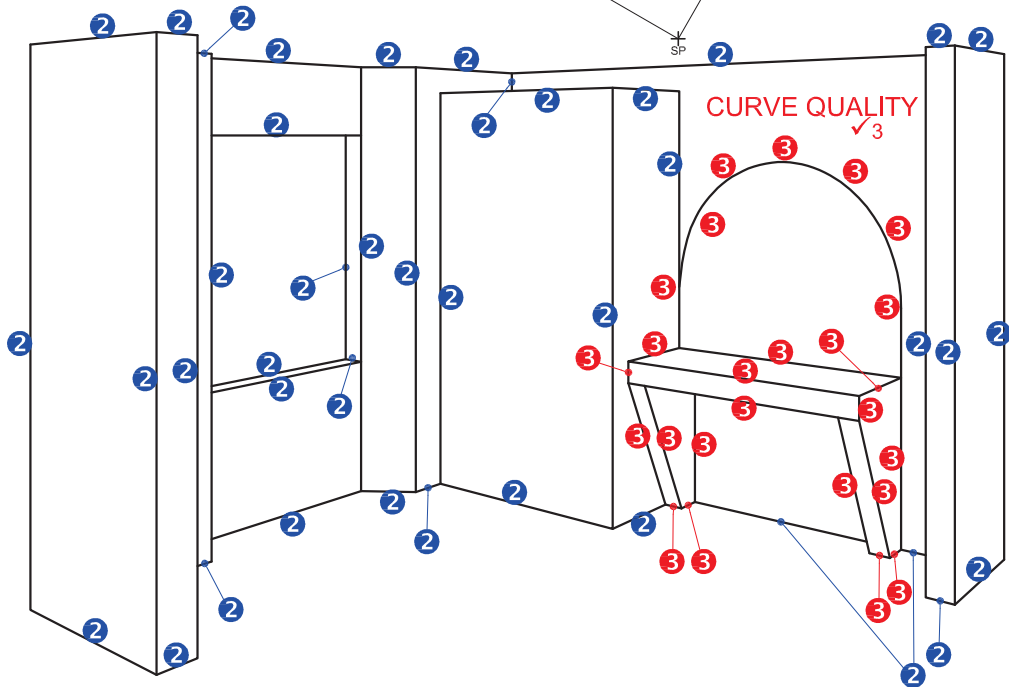
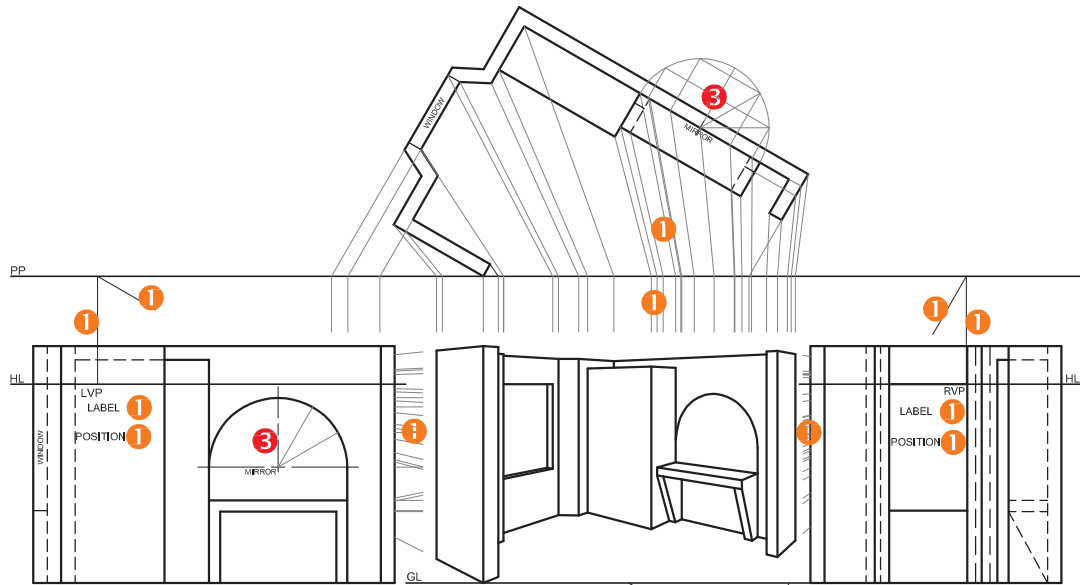

PAPER 1 QUESTION 3
 GRADE 12
 NOVEMBER 2021
 MARKING GUIDELINE

ASSESSMENT CRITERIA		
1	CONSTRUCTION	6
2	WALLS + CUPBOARD + WINDOW	20
3	TABLE + MIRROR	14
TOTAL		40

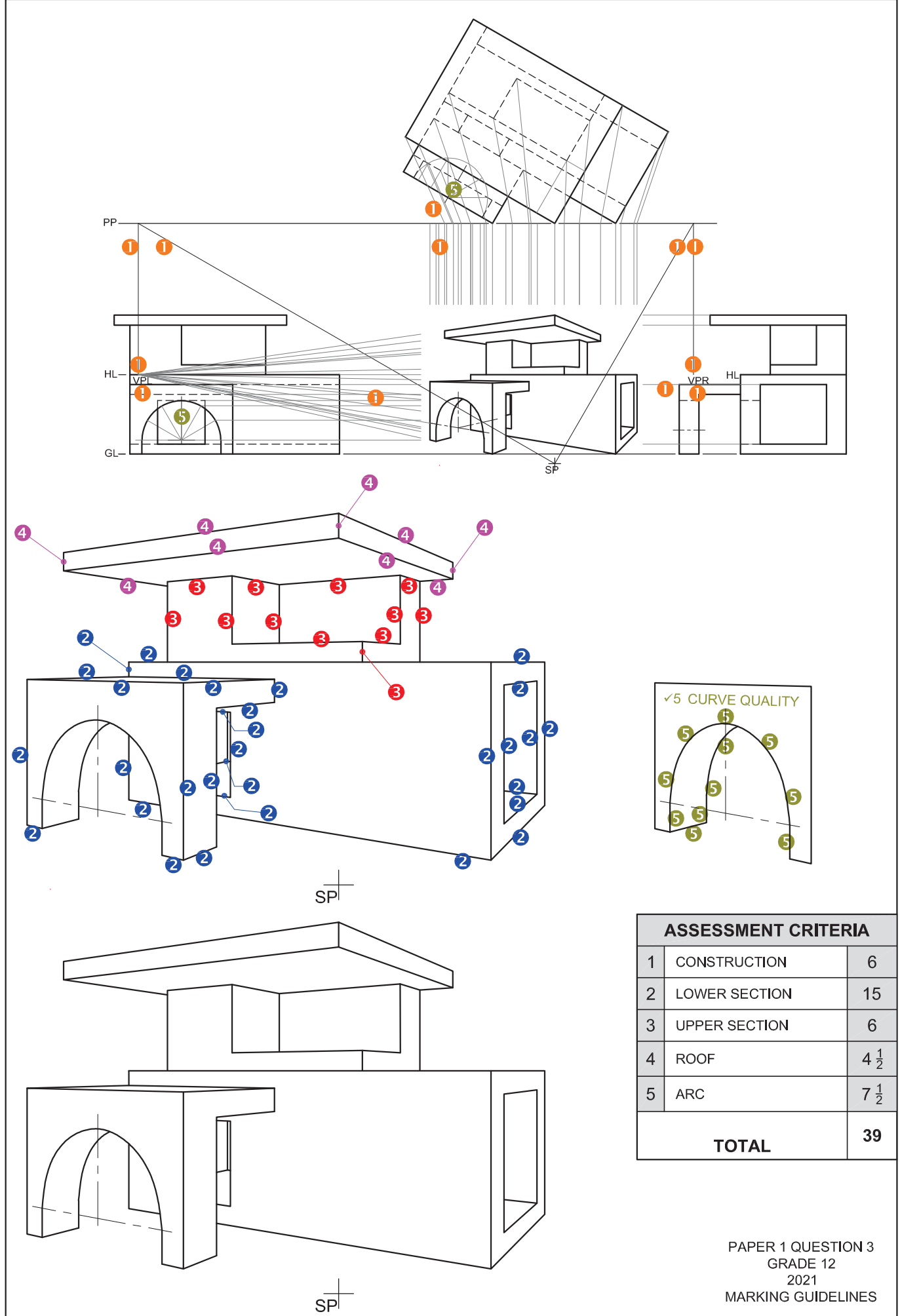

ASSESSMENT CRITERIA		
1	CONSTRUCTION	6
2	LOWER SECTION	15
3	UPPER SECTION	6
4	ROOF	4 1/2
5	ARC	7 1/2
TOTAL		39

PAPER 1 QUESTION 3
 GRADE 12
 2021
 MARKING GUIDELINES

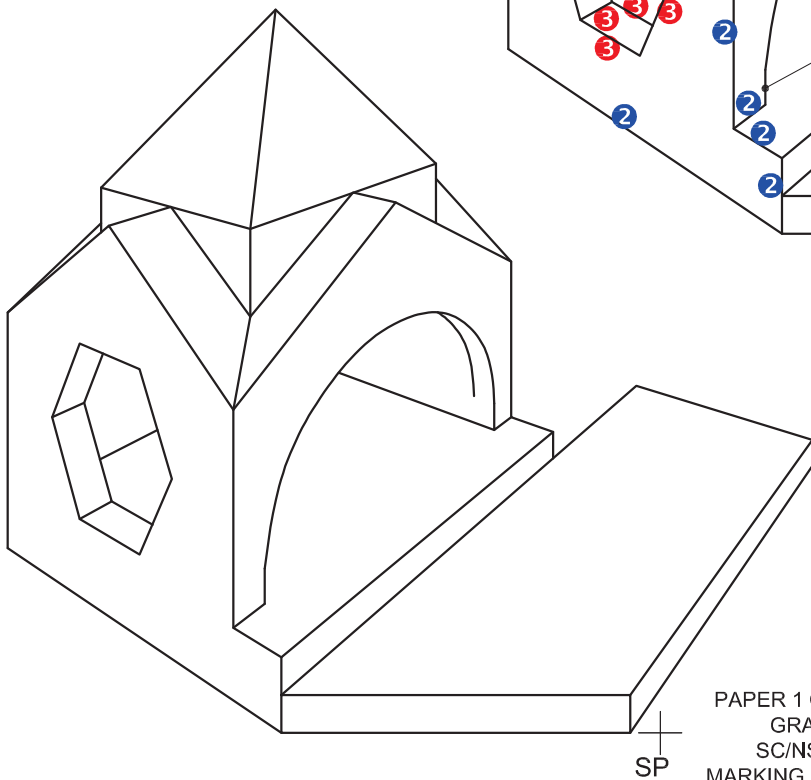
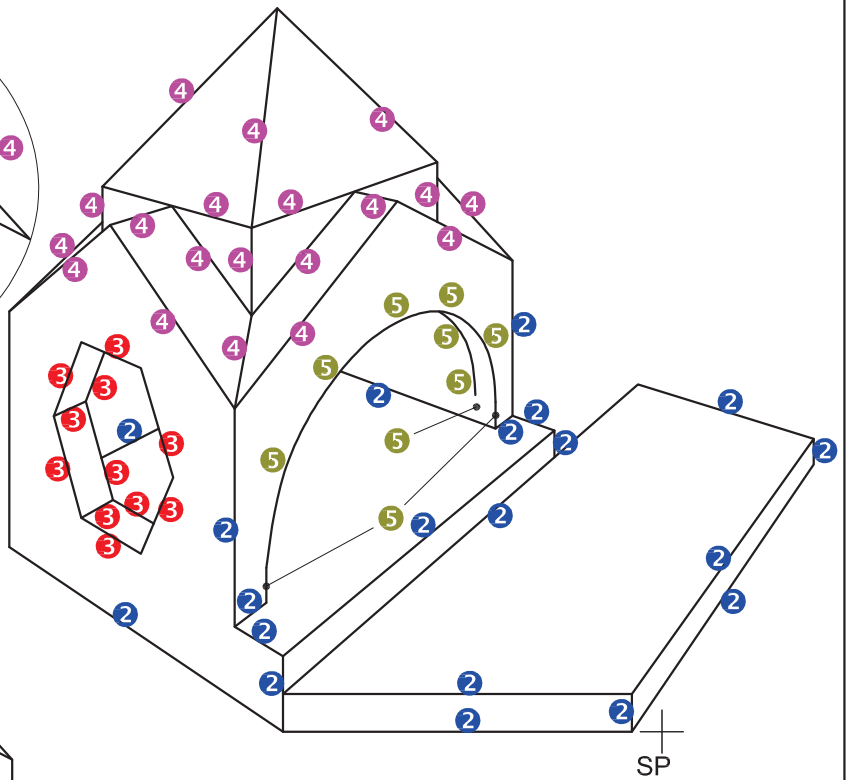
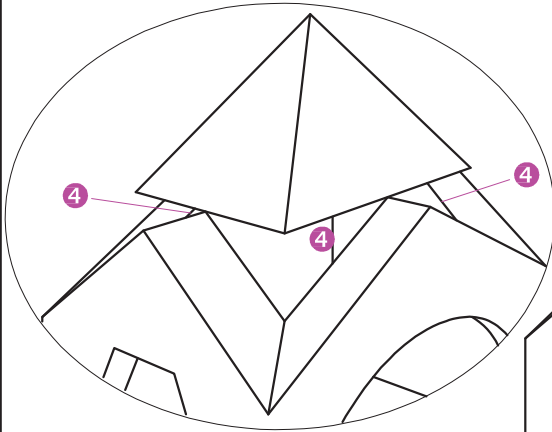
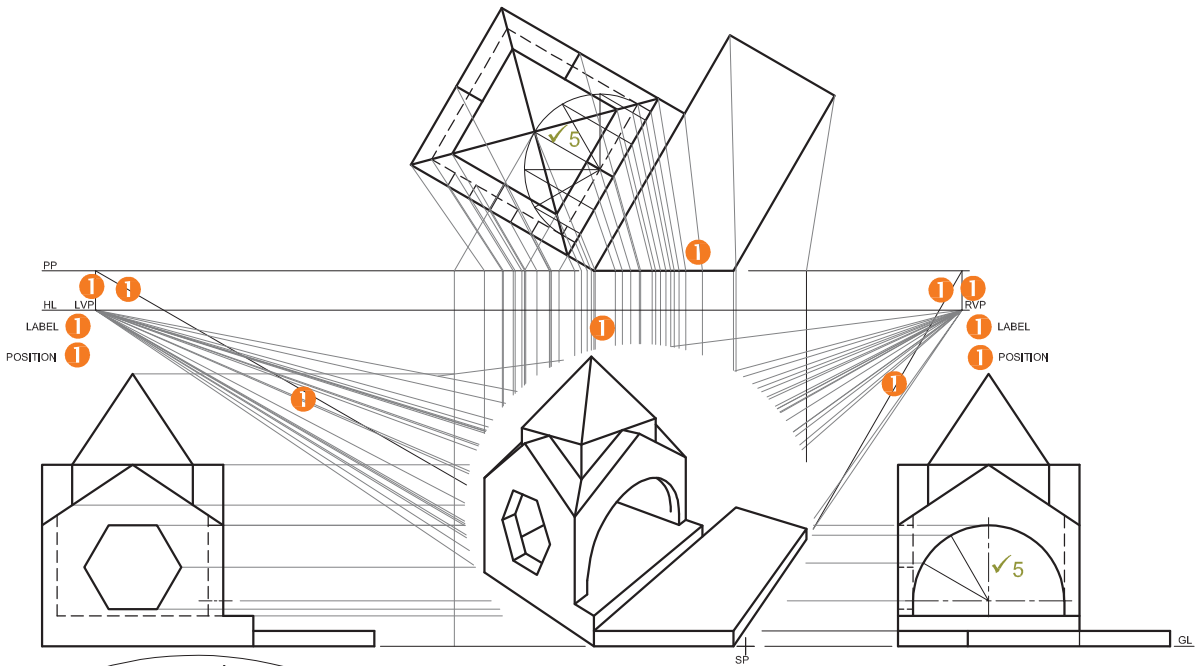

PAPER 1 QUESTION 3
 GRADE 12
 SC/NSC 2020
 MARKING GUIDELINES

ASSESSMENT CRITERIA		
1	CONSTRUCTION	6
2	WALLS	10½
3	HEXAGONAL OPENING	5½
4	ROOF	9½
5	CURVE	6½
TOTAL		38

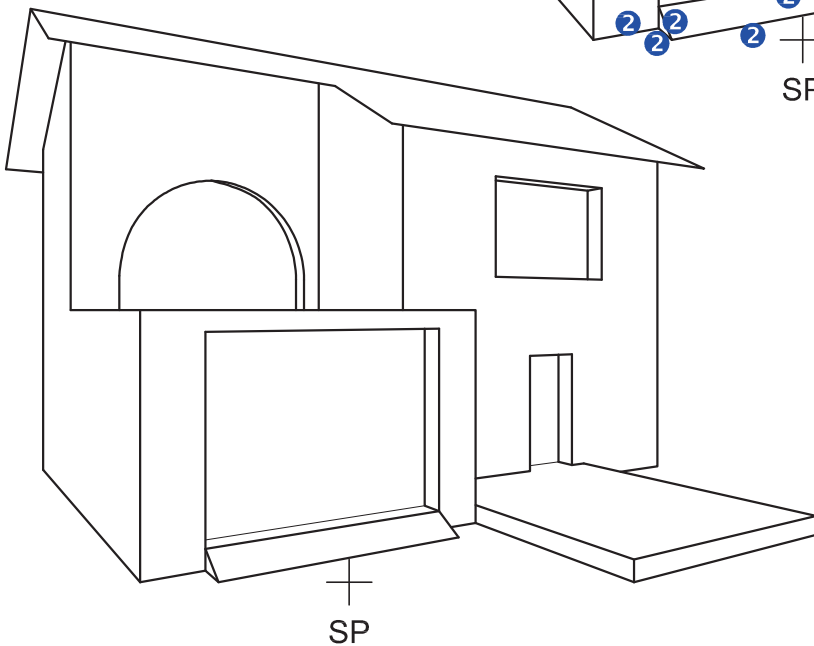
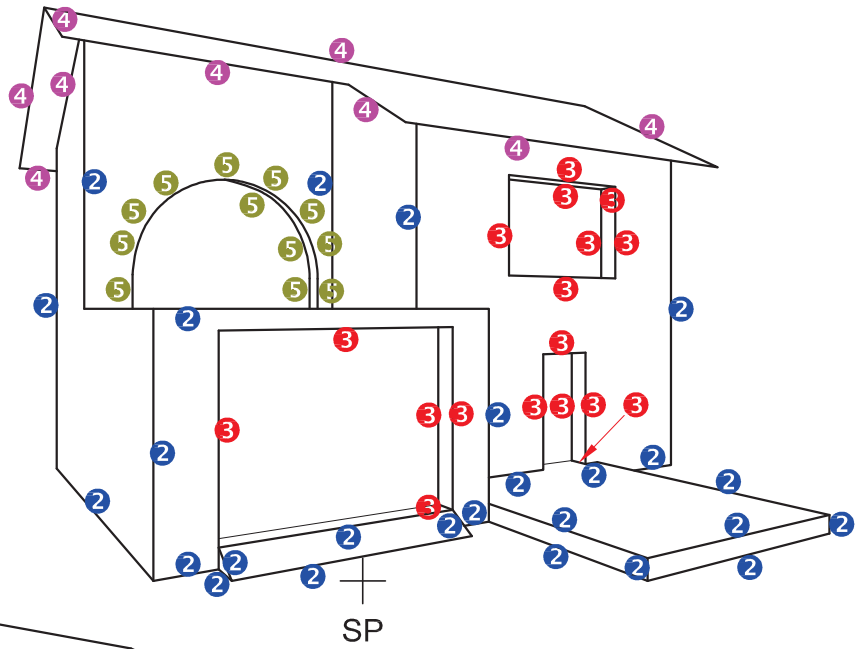
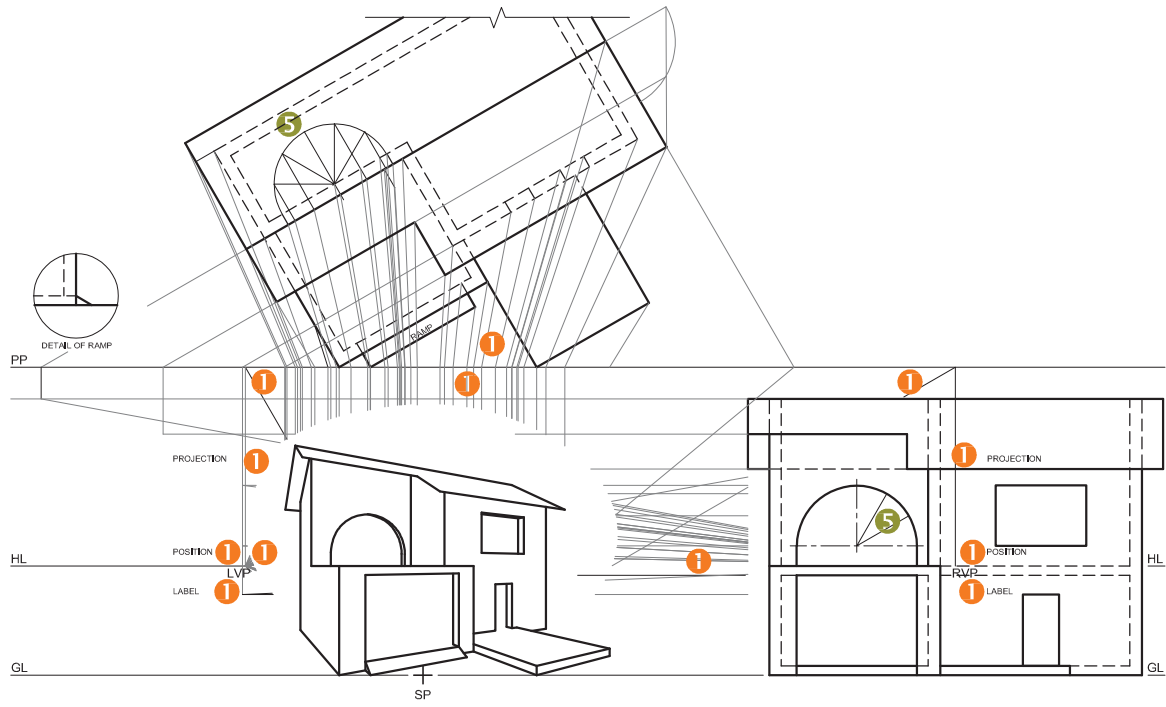

ASSESSMENT CRITERIA		
1	CONSTRUCTION	6
2	WALLS	13
3	DOORS + WINDOWS	8½
4	ROOF	4½
5	ARCS	7
TOTAL		39

PAPER 1 QUESTION 3
 GRADE 12
 NOVEMBER 2019
 MARKING GUIDELINE

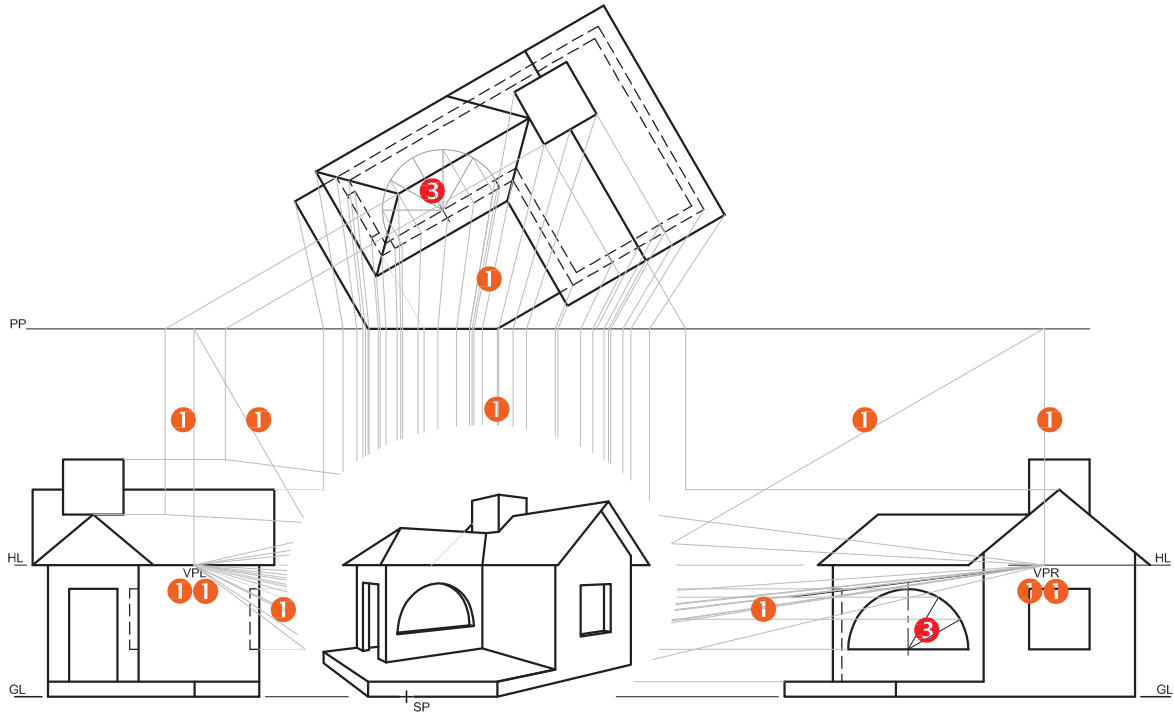

3✓ CURVE QUALITY

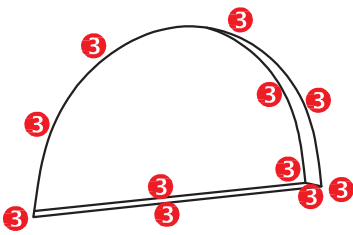

DETAILS OF THE MARK ALLOCATION FOR THE ARC

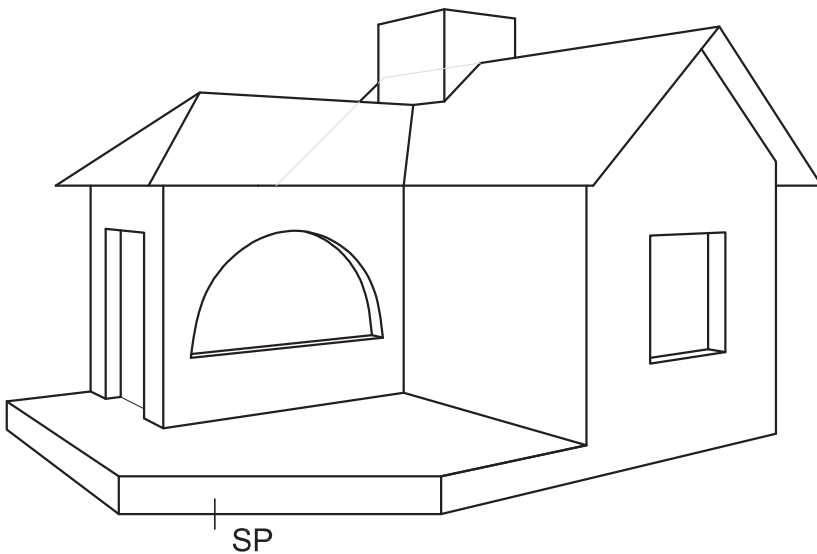
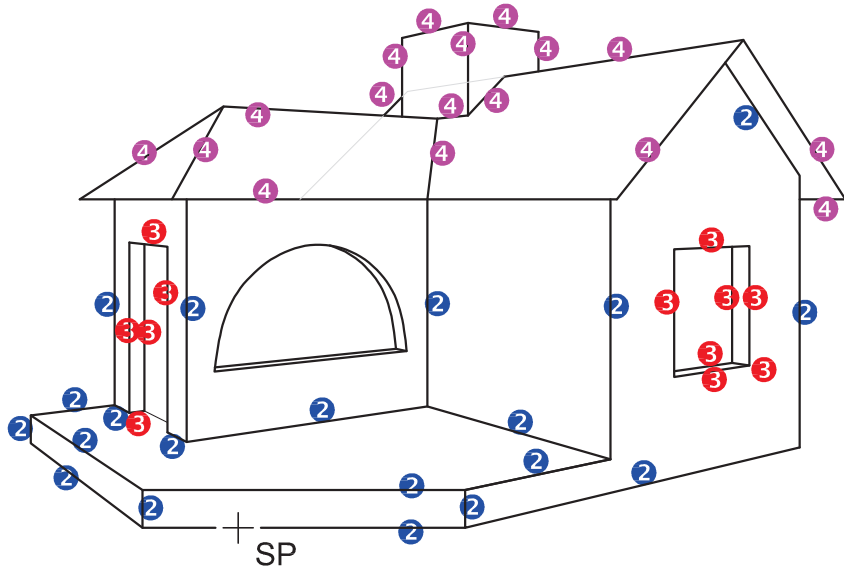

ASSESSMENT CRITERIA		
1	CONSTRUCTION	6
2	FLOOR AND WALLS	10
3	DOOR AND WINDOWS	13 1/2
4	ROOF	8 1/2
TOTAL		38

APPROVED
 PAPER 1 QUESTION 3
 GRADE 12
 SC/NSC 2019
 MARKING GUIDELINES

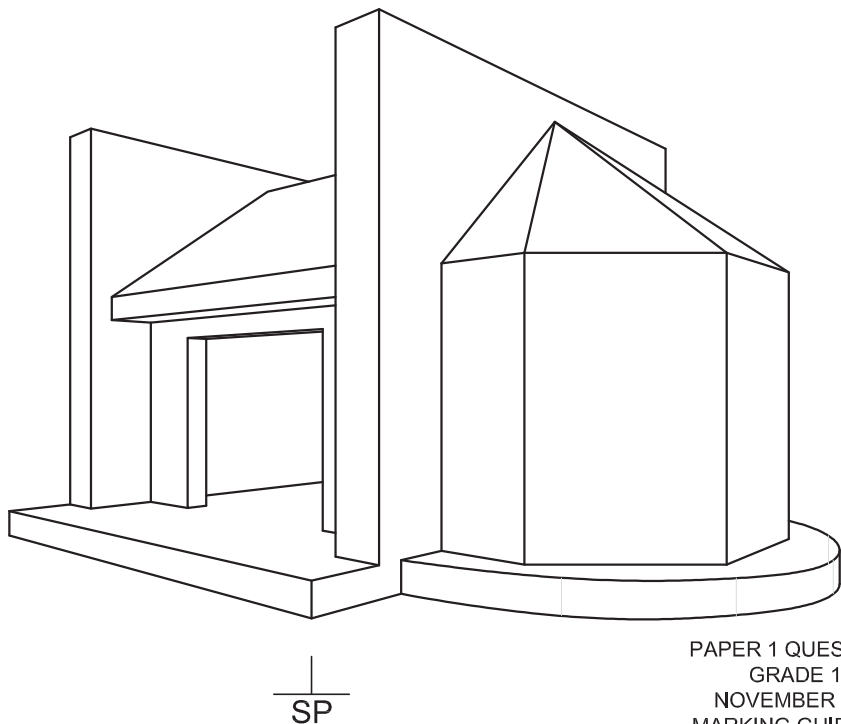
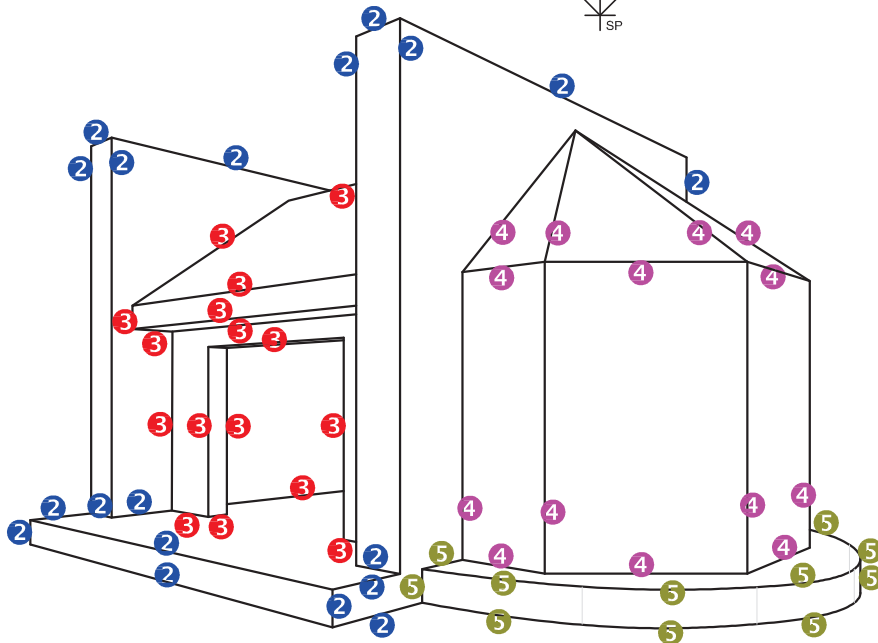
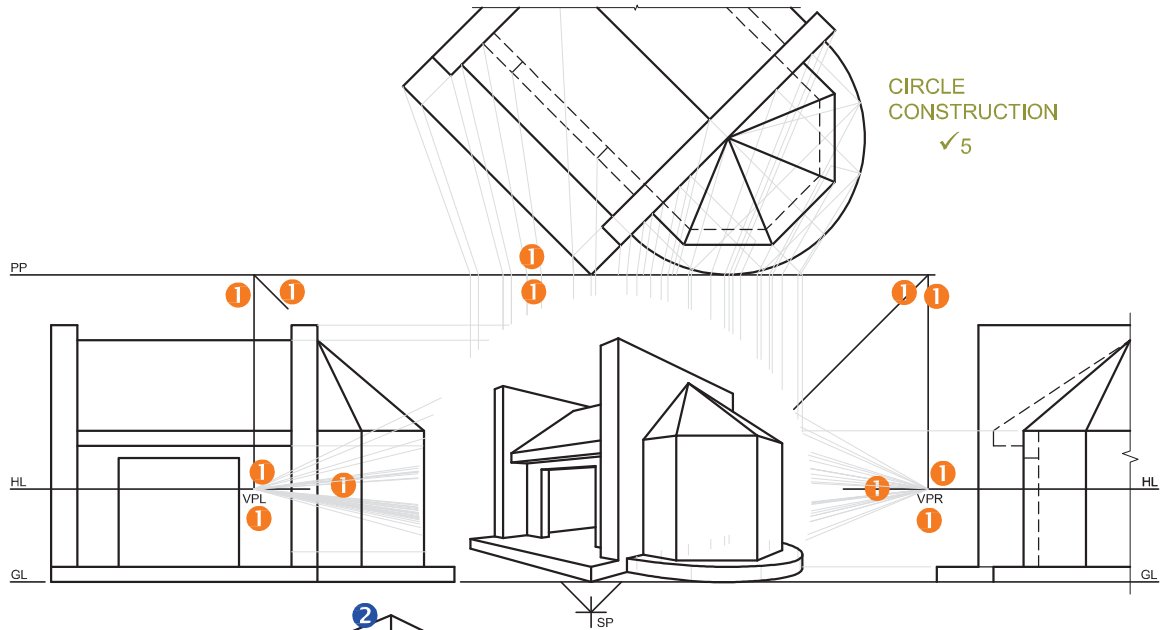

ASSESSMENT CRITERIA		
1	CONSTRUCTION	6
2	OUTER STRUCTURE	9 ¹ / ₂
3	INNER STRUCTURE	8
4	SIDE STRUCTURE	7
5	ARCS	6 ¹ / ₂
PENALTIES (-)		
TOTAL		37

PAPER 1 QUESTION 3
 GRADE 12
 NOVEMBER 2018
 MARKING GUIDELINE

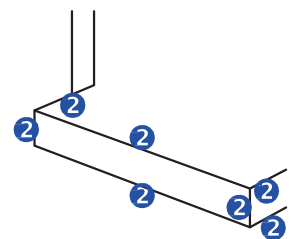
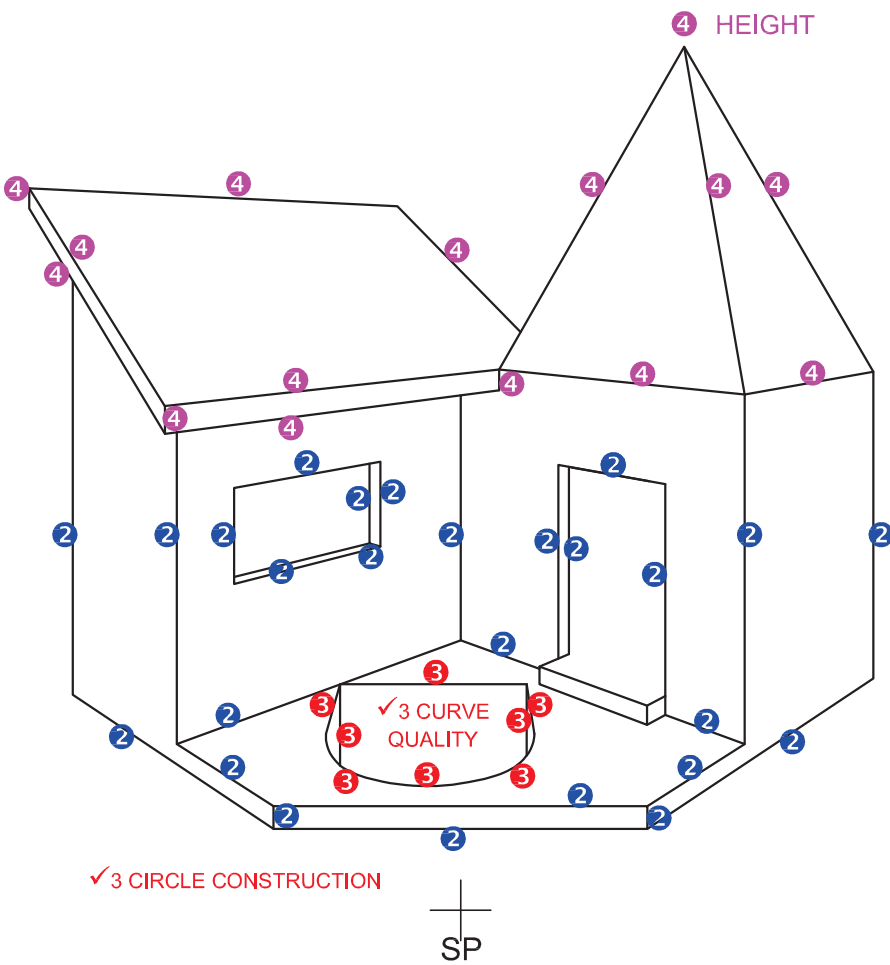
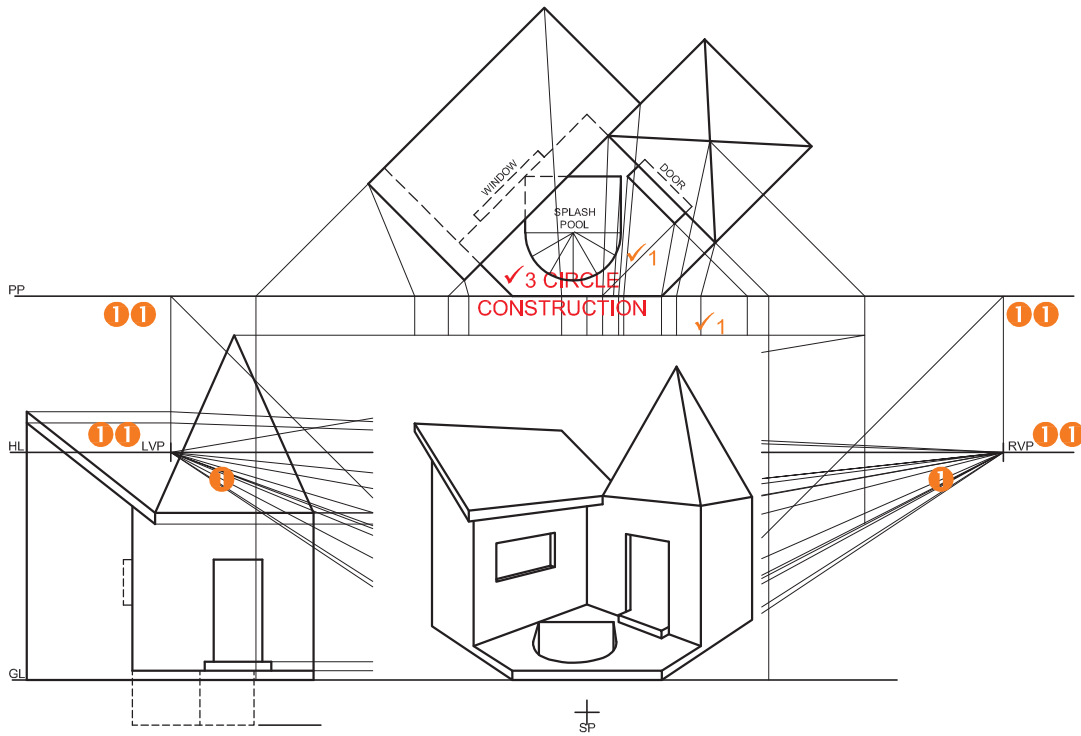

DETAIL OF MARK ALLOCATION FOR THE DOORSTEP

ASSESSMENT CRITERIA		
1	CONSTRUCTION	7
2	WALLS, WINDOW, DOOR	16 $\frac{1}{2}$
3	SPLASH POOL	7
4	ROOF	7 $\frac{1}{2}$
TOTAL		38

PAPER 1 QUESTION 3
 GRADE 12
 SCE 2018
 MARKING GUIDELINES

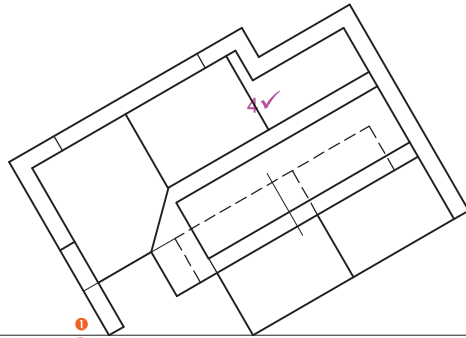

PP

00

1

1 1

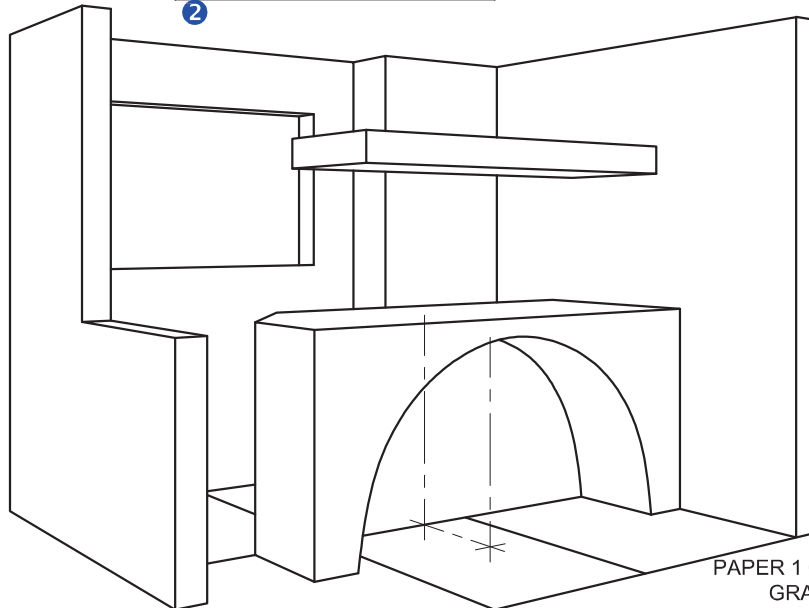
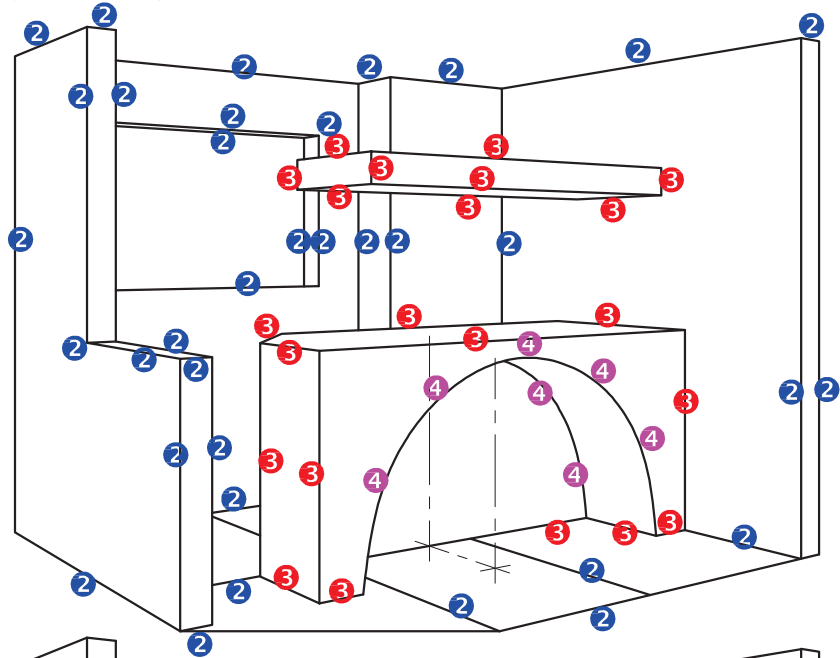
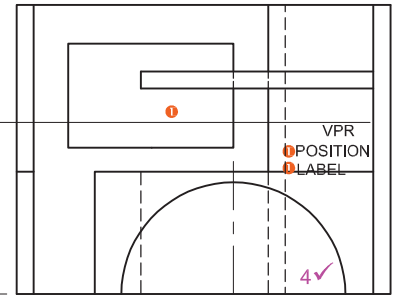
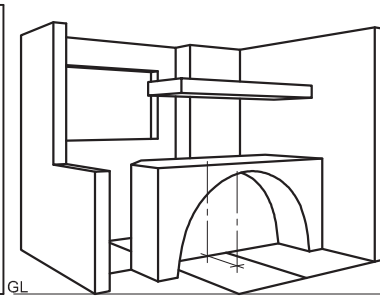
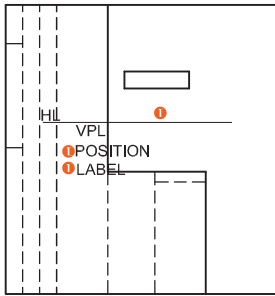

ASSESSMENT CRITERIA		
1	CONSTRUCTION	6
2	WALLS AND WINDOW	17½
3	COUNTER	11
4	SEMICIRCLE	5½
TOTAL		40

PAPER 1 QUESTION 3
 GRADE 12
 NOVEMBER 2017
 MARKING GUIDELINES

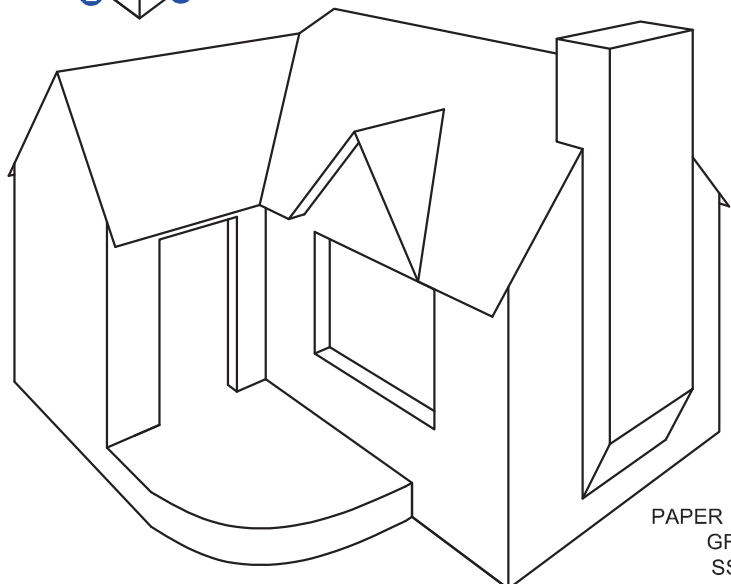
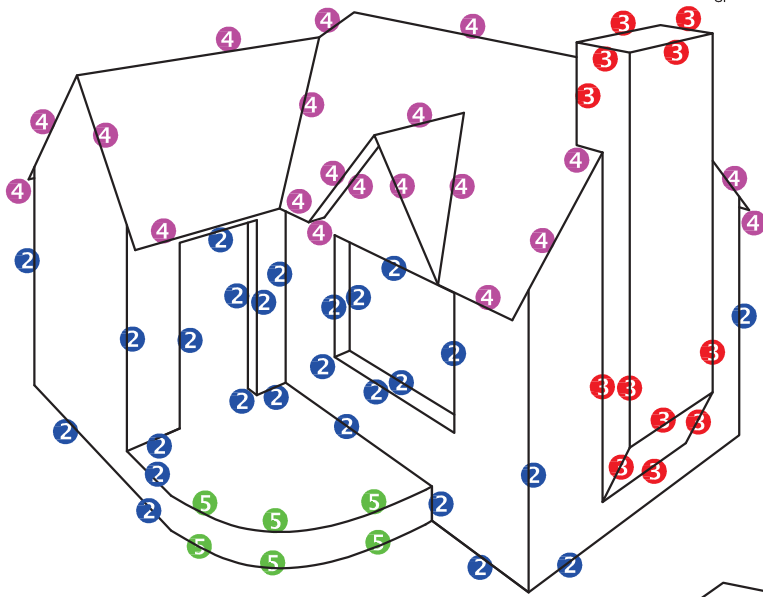
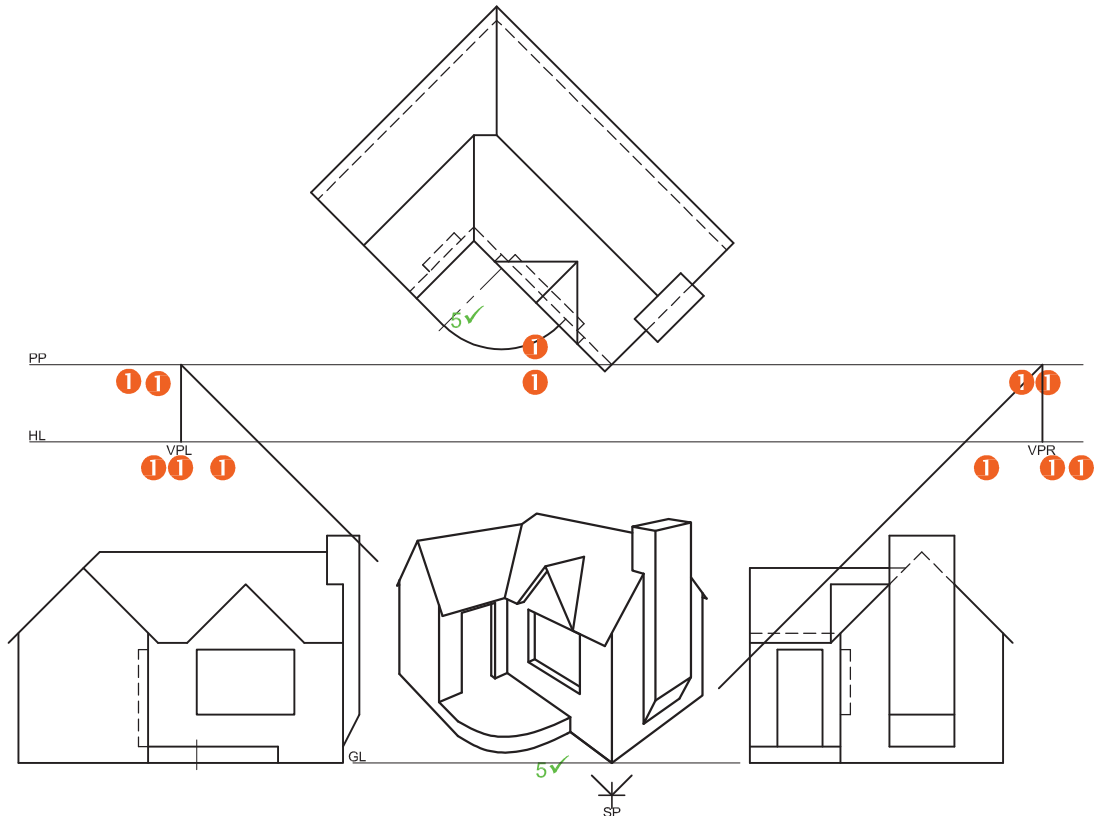

ASSESSMENT CRITERIA		
1	CONSTRUCTION	6
2	WALLS, WINDOW, DOOR	13
3	CHIMNEY	6
4	ROOF	10
5	ARC	5
TOTAL		40

PAPER 1 QUESTION 3
 GRADE 12
 SSE 2017
 MARKING GUIDELINES

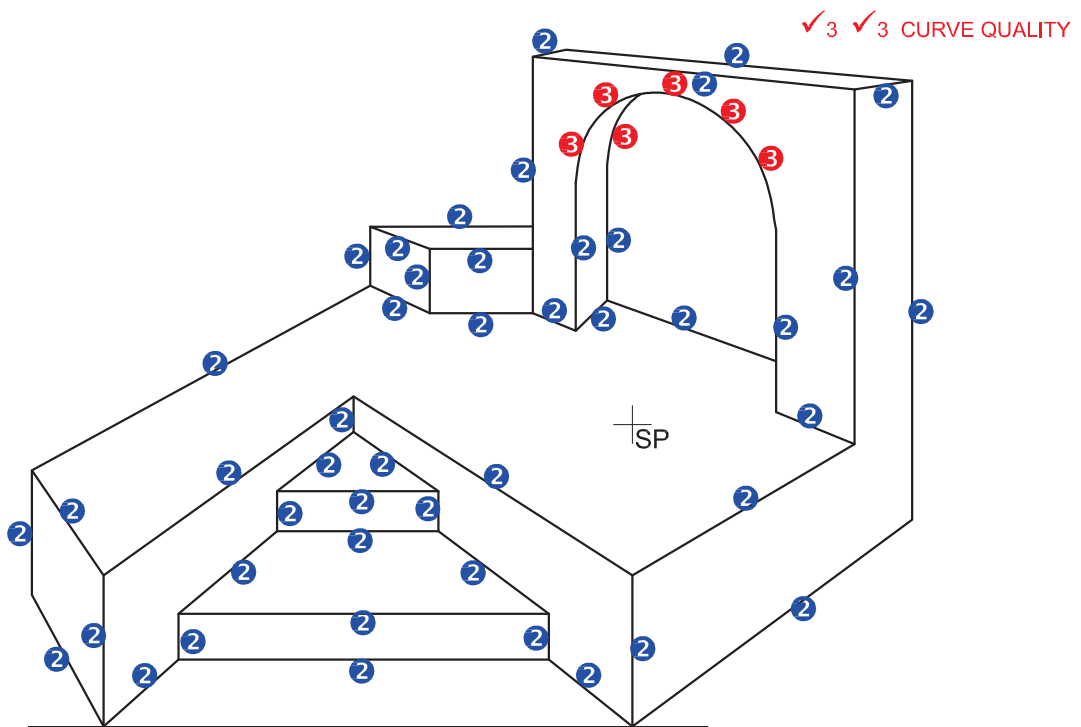
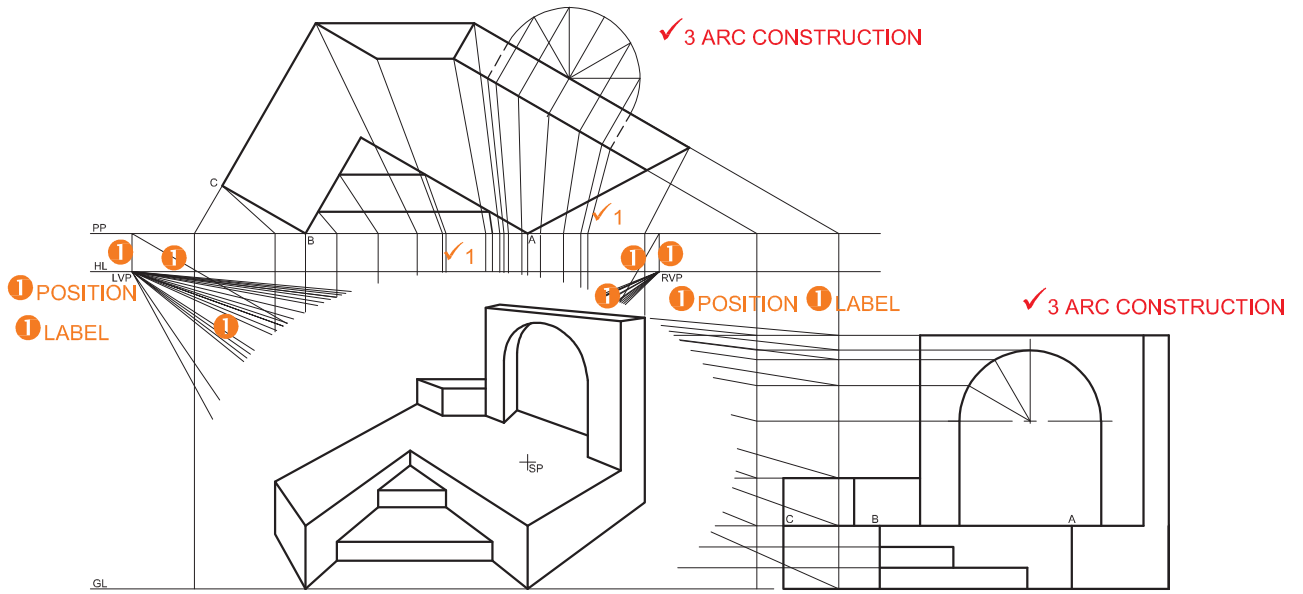

ASSESSMENT CRITERIA		
1	CONSTRUCTION + VPs	7
2	STEPS + FLOOR + WALLS	23
3	CIRCULAR ARC	7
TOTAL		37

PAPER 1 QUESTION 3
 GRADE 12
 Feb.-Mar. 2017
 MEMORANDUM

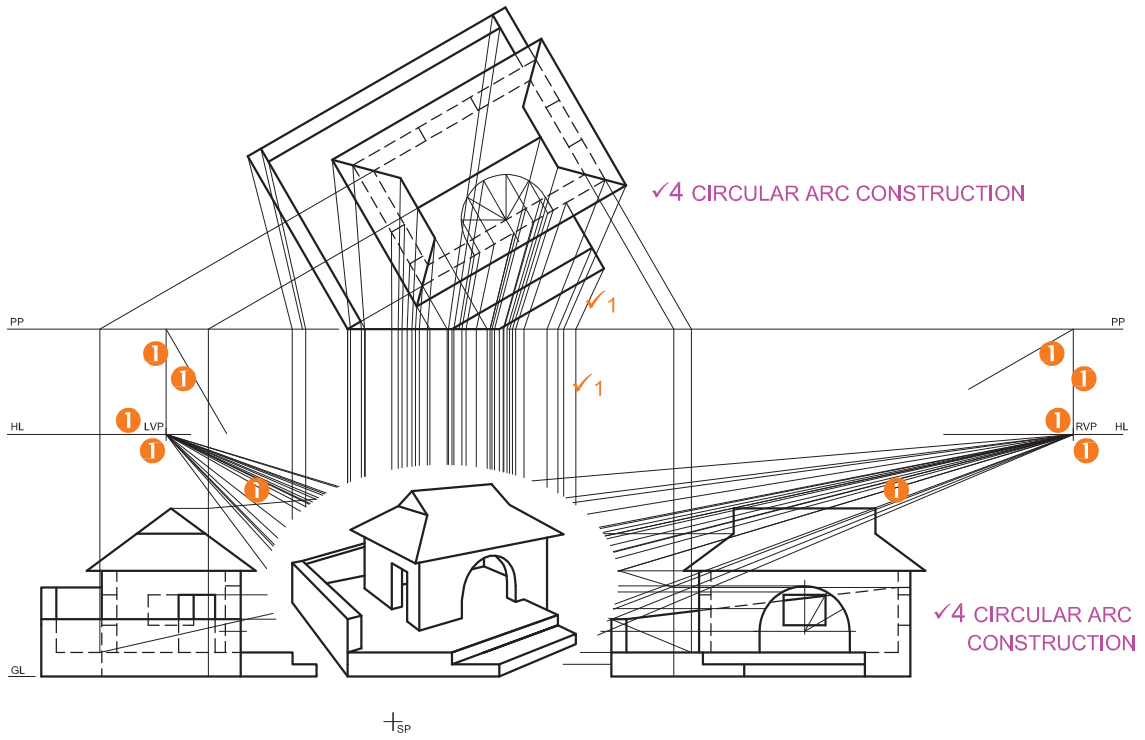

✓4 CURVE QUALITY

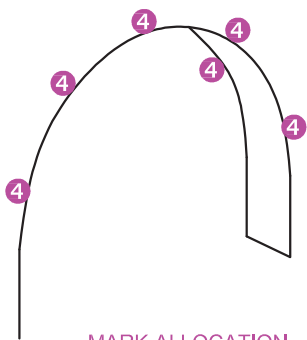

MARK ALLOCATION FOR THE CIRCULAR ARC

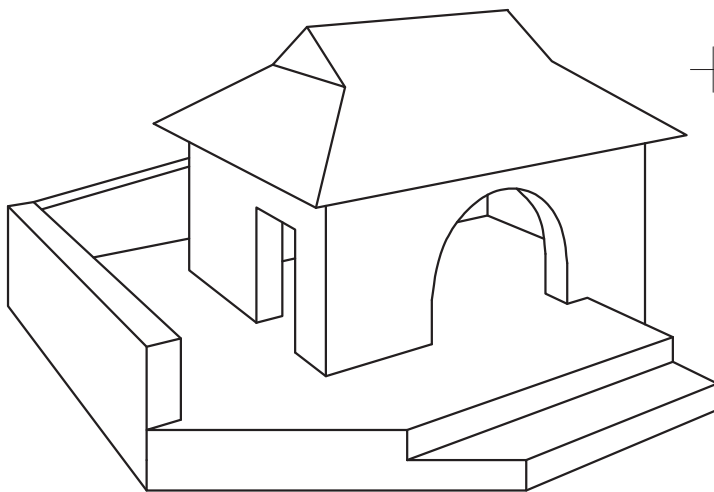
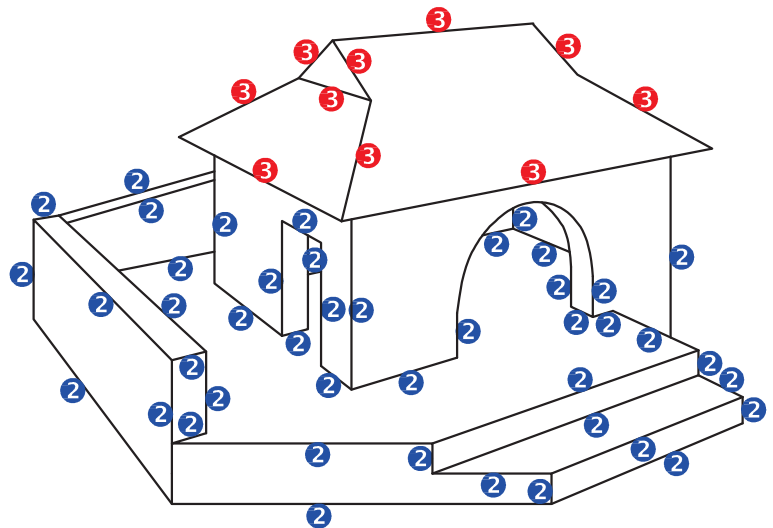

PAPER 1 QUESTION 3
 GRADE 12
 NOVEMBER 2016
 MEMORANDUM

ASSESSMENT CRITERIA		
1	CONSTRUCTION + VP's	7
2	WALLS + DOORS	22
3	ROOF	5
4	CIRCULAR ARC	6
TOTAL		40

PP

HL

VPL

GL

VPR

SP

SP

ASSESSMENT CRITERIA		
1	CONSTRUCTION + VPs	5
2	FLOOR	4
3	GROUND FLOOR	12
4	FIRST FLOOR	12
5	WINDOW + DOOR	6
TOTAL		39

PAPER 1 QUESTION 3
 GRADE 12
 Feb.-Mar.2016
 MEMORANDUM

ASSESSMENT CRITERIA

1	CONSTRUCTION + VPs	6
2	BASE + STAIRS	12½
3	POOL	13½
4	CIRCULAR ARC	7
TOTAL		39

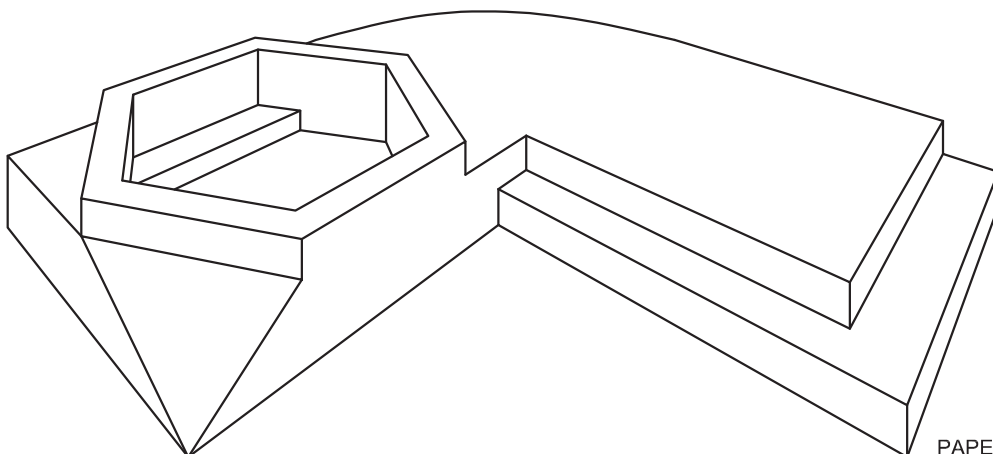
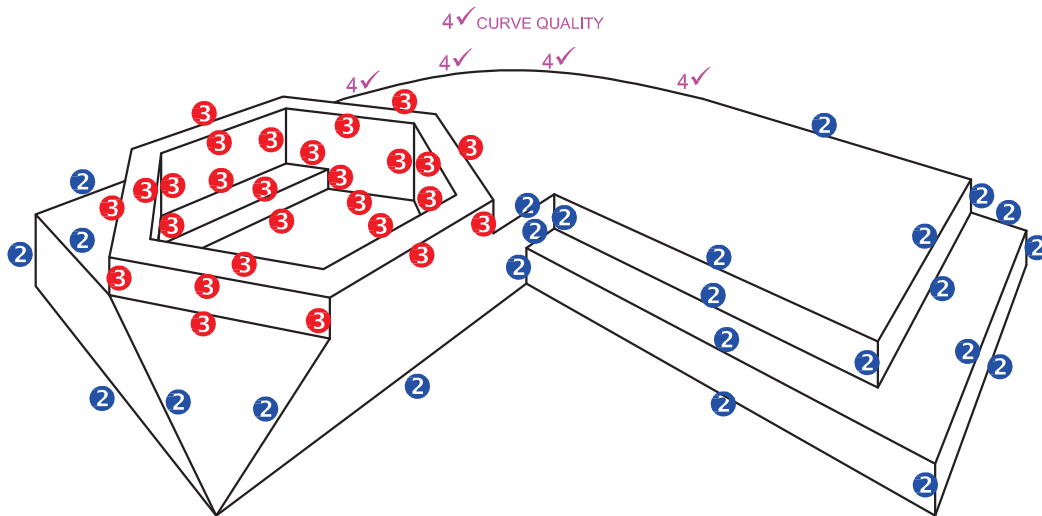
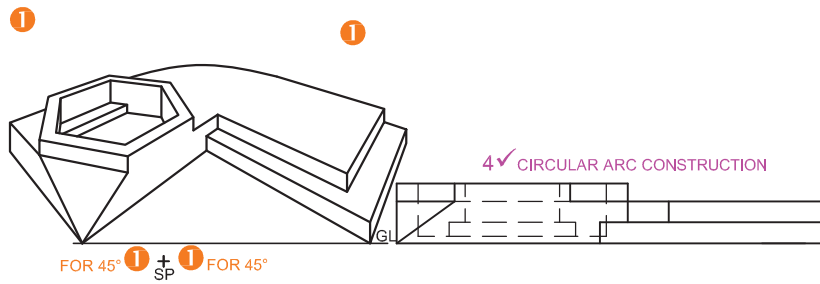
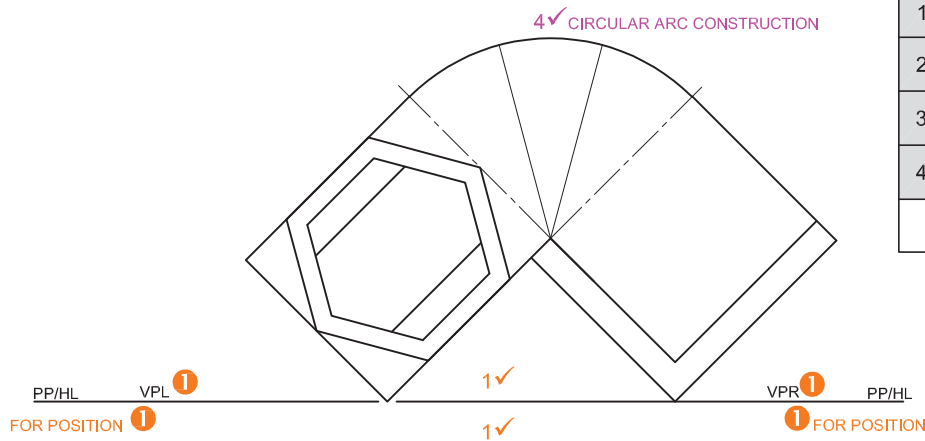

SP

PAPER 1 QUESTION 3
 GRADE 12
 November 2015
 MEMORANDUM

ASSESSMENT CRITERIA

1	CONSTRUCTION + VPs	7
2	ROOF	4
3	WALLS	17
4	QUARTER-CIRCLE	6
5	WINDOW + DOOR	6
TOTAL		40

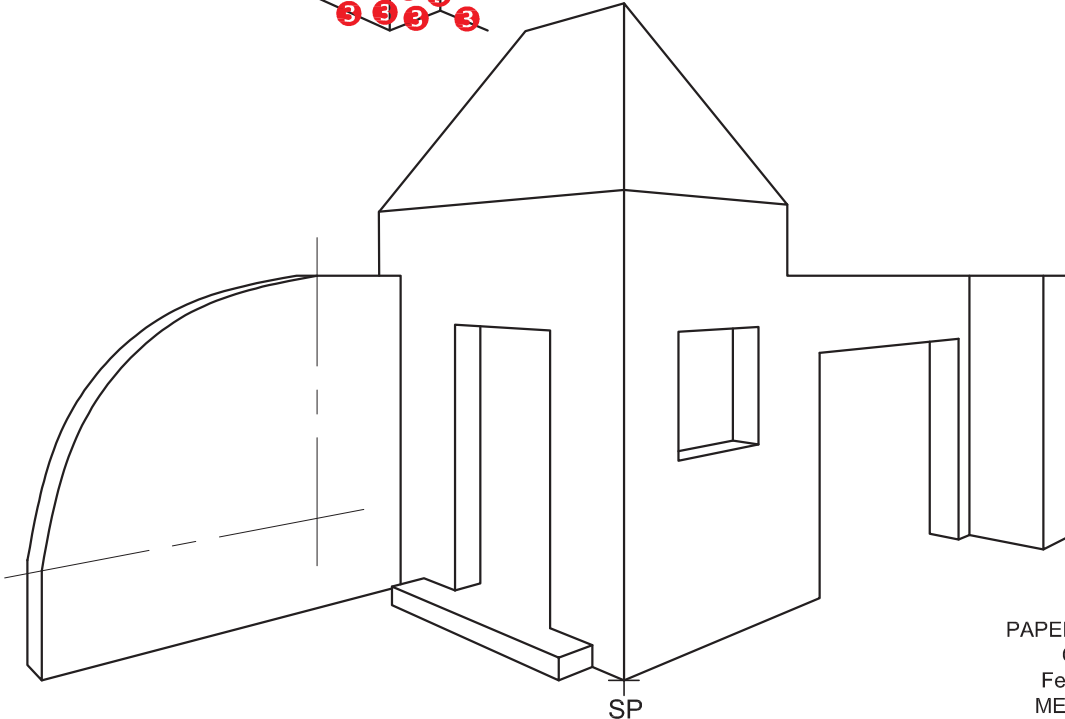
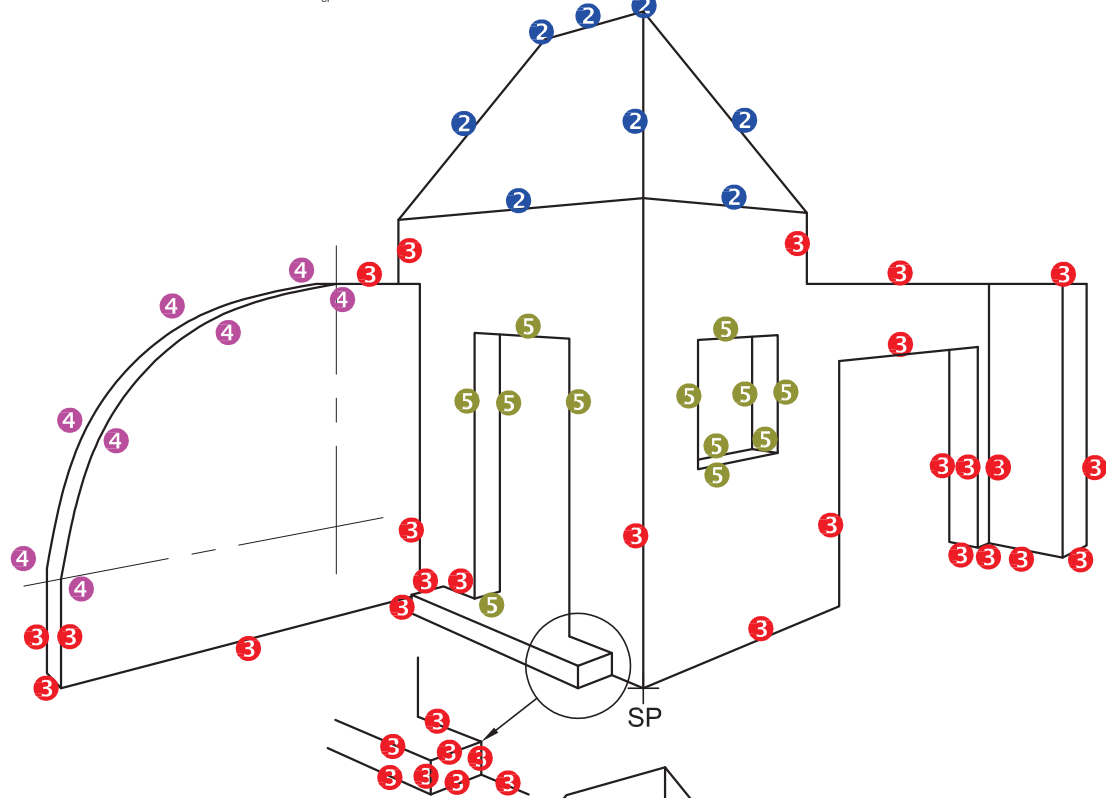
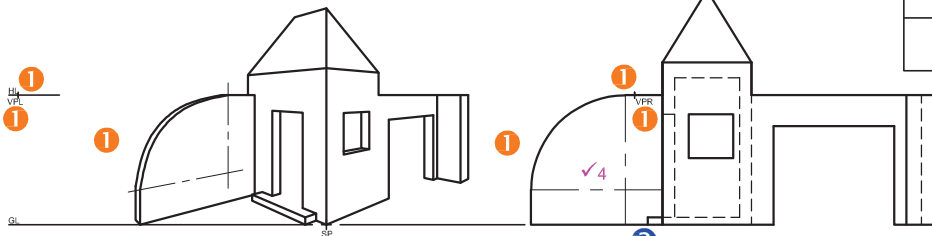
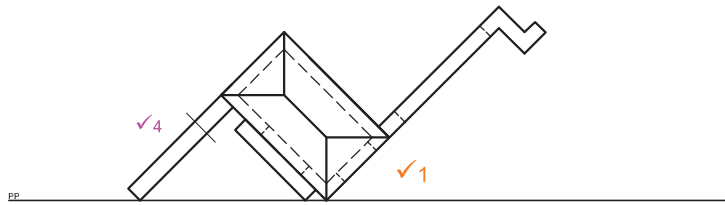

PAPER 1 QUESTION 3
 GRADE 12
 Feb.-Mar. 2015
 MEMORANDUM

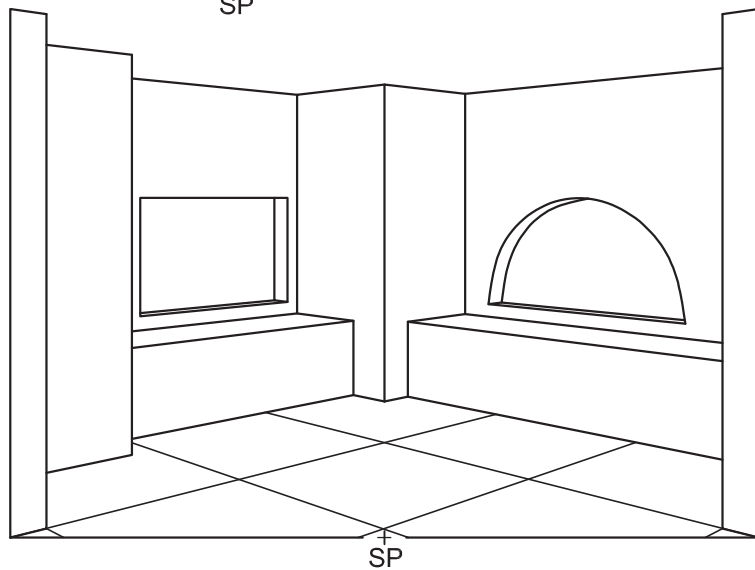
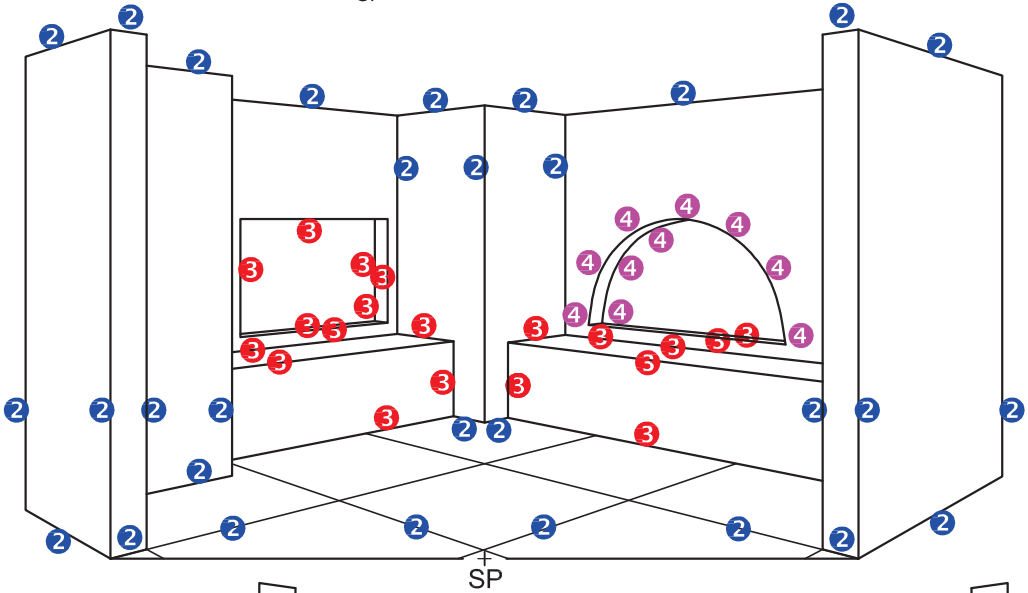
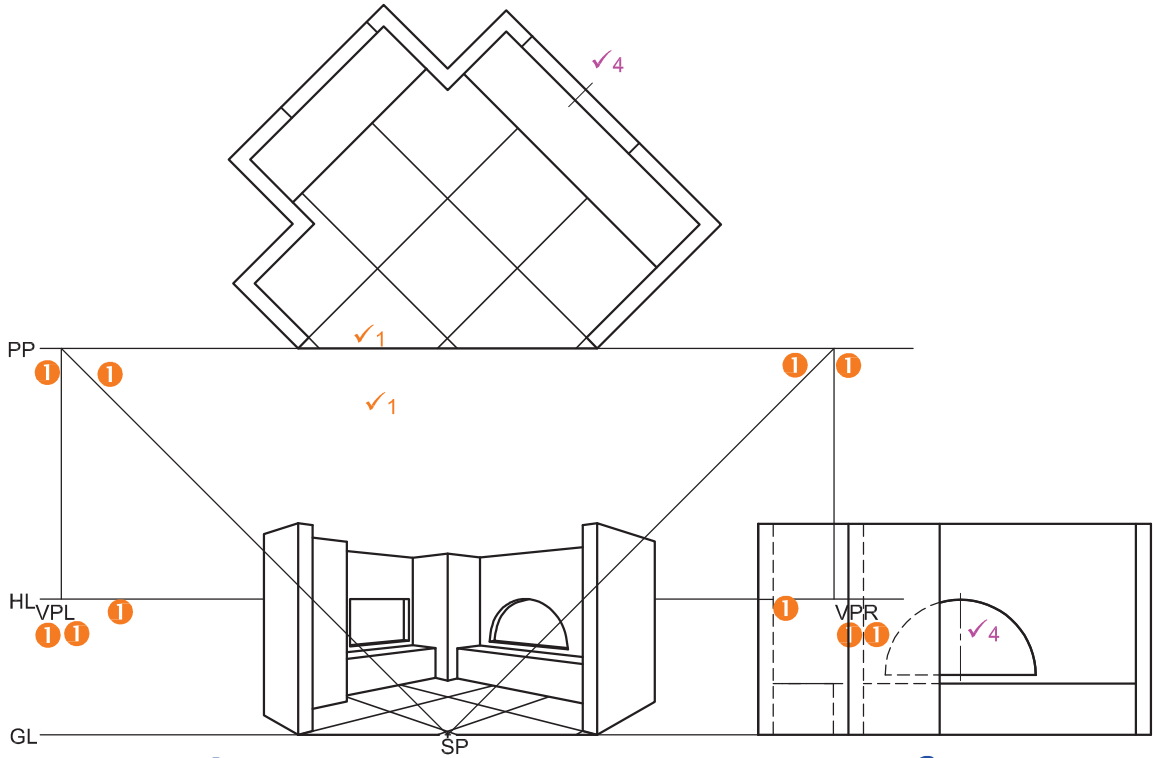

ASSESSMENT CRITERIA		
1	CONSTRUCTION + VPs	7
2	WALLS + TILES	15
3	OPENINGS + SEATING	10
4	SEMI-CIRCLE	7
TOTAL		39

PAPER 1 QUESTION 3
 GRADE 12
 NOVEMBER 2014
 MEMORANDUM

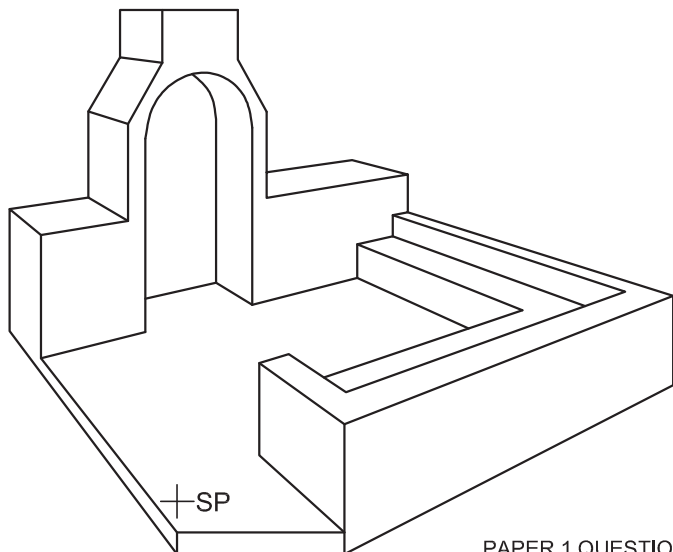
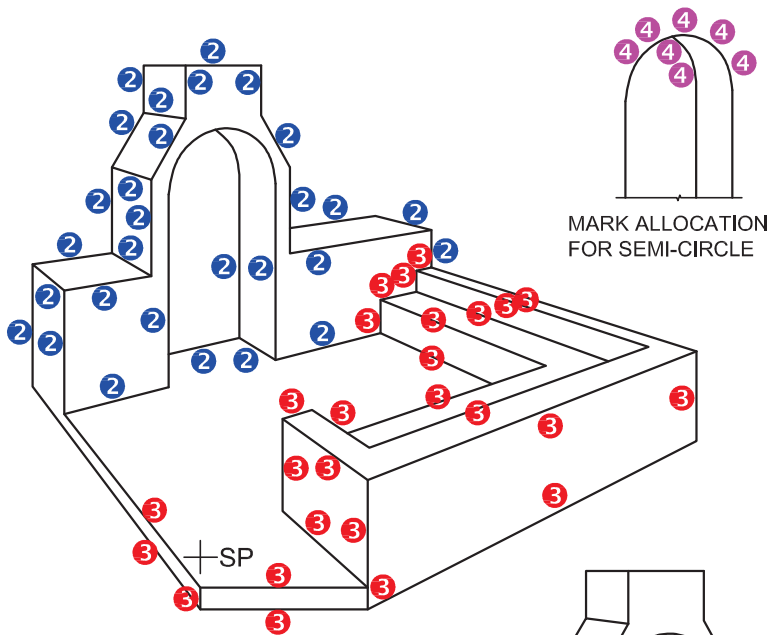
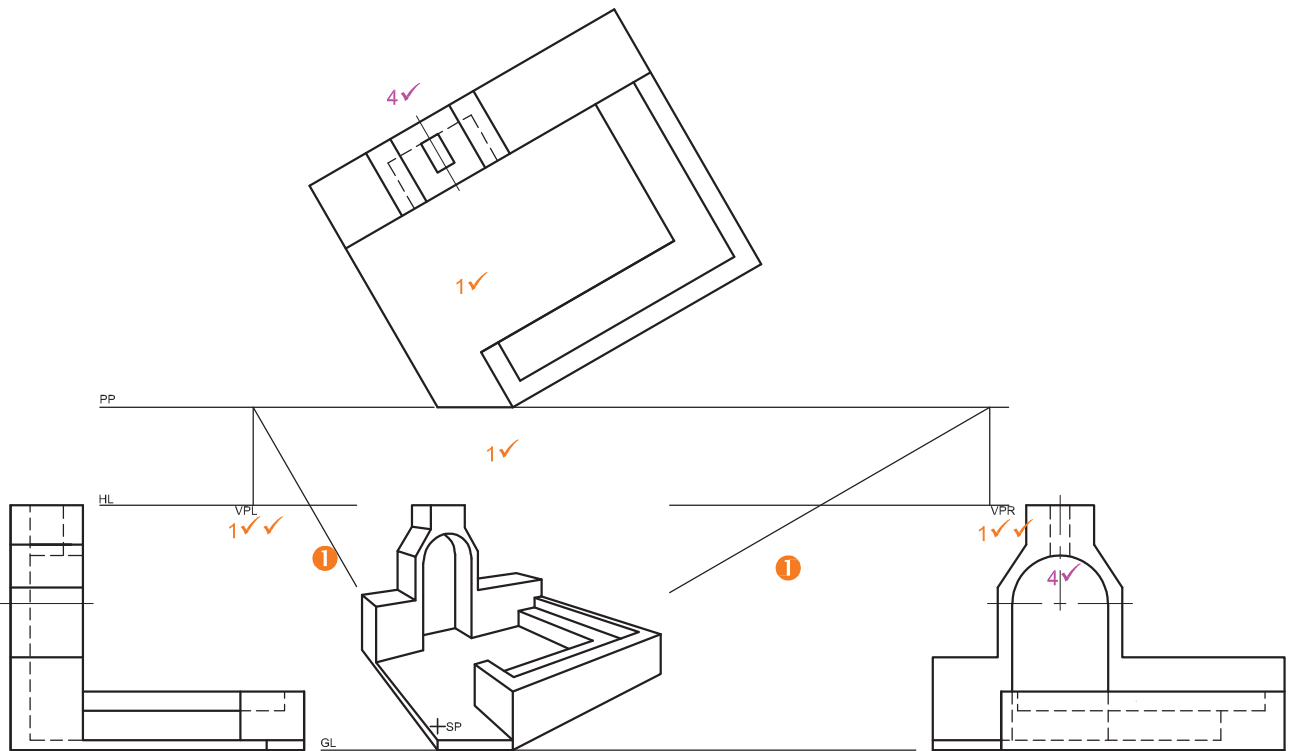

ASSESSMENT CRITERIA		
1	CONSTRUCTION + VPs	7
2	BRAAI	14½
3	SEATING	13
4	SEMI-CIRCLE	5½
TOTAL		40

PAPER 1 QUESTION 3
 GRADE 12
 EXEMPLAR 2014
 MEMORANDUM

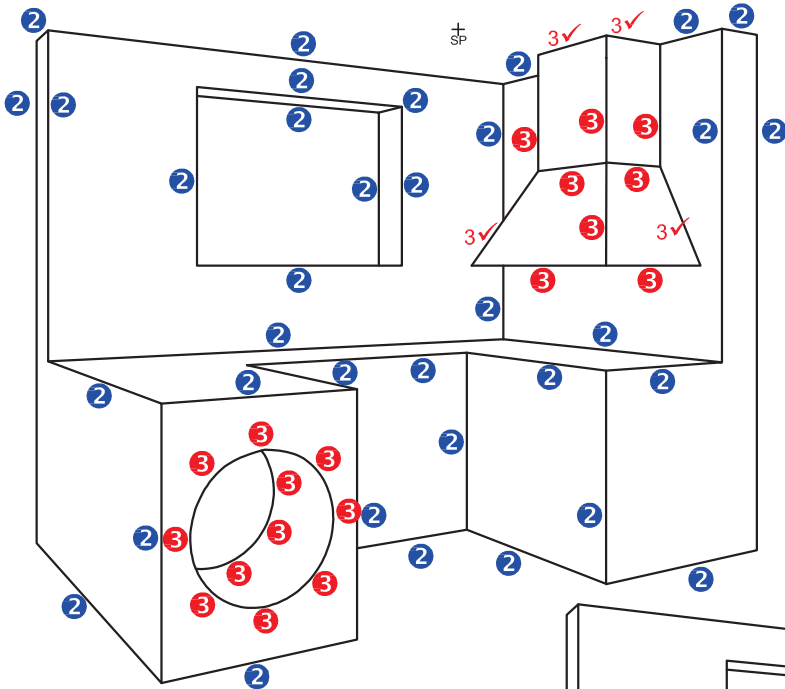
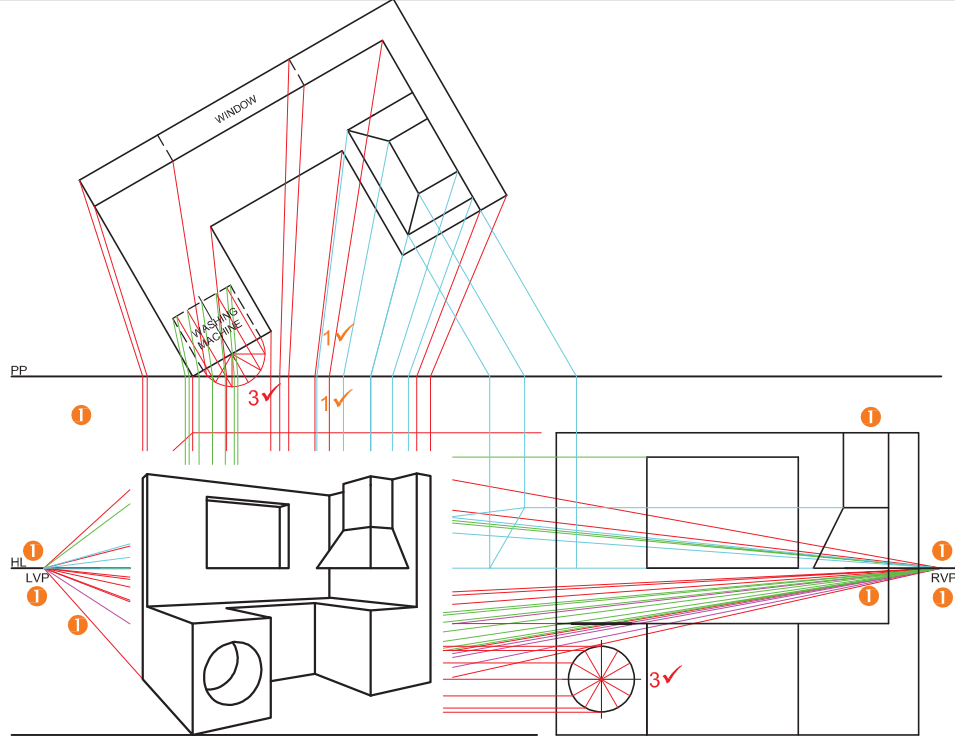

SP

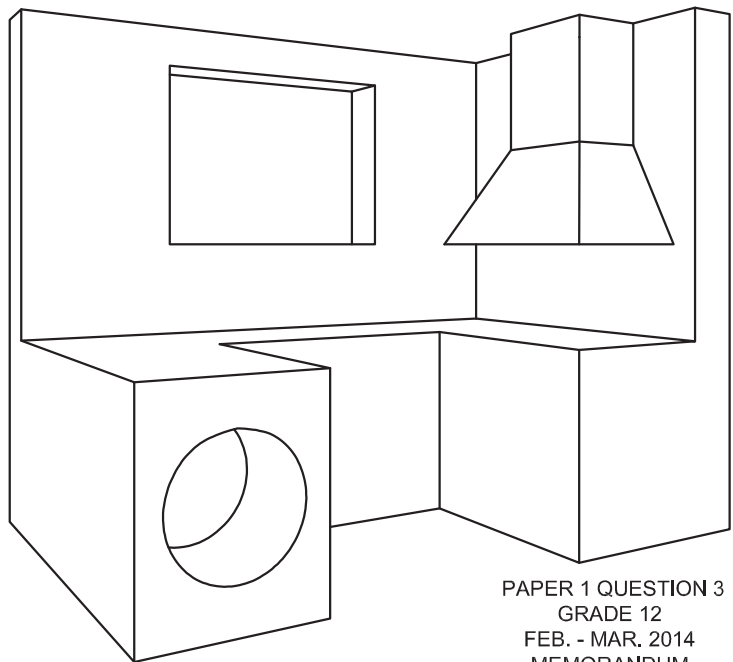

ASSESSMENT CRITERIA		
1	CONSTRUCTION + VPs	6
2	WALLS + CUPBOARDS	17½
3	EXTRACTOR + CIRCLES	15½
TOTAL		39

PAPER 1 QUESTION 3
 GRADE 12
 FEB. - MAR. 2014
 MEMORANDUM

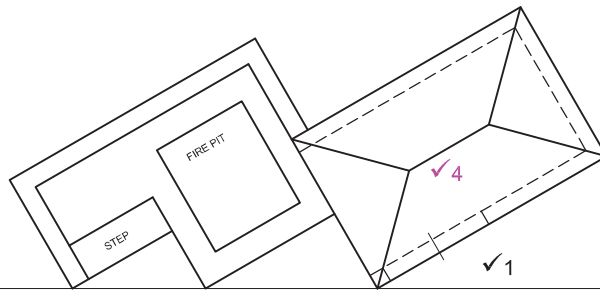

PP

1 1

✓1

1 1

1
HL
VPR

1
VPL

✓1

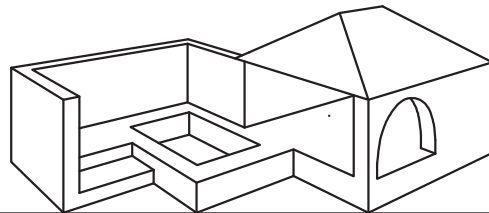

✓1

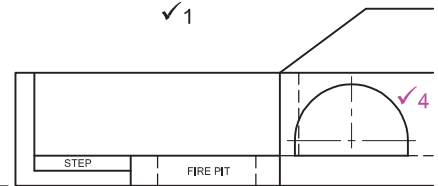

GL

+

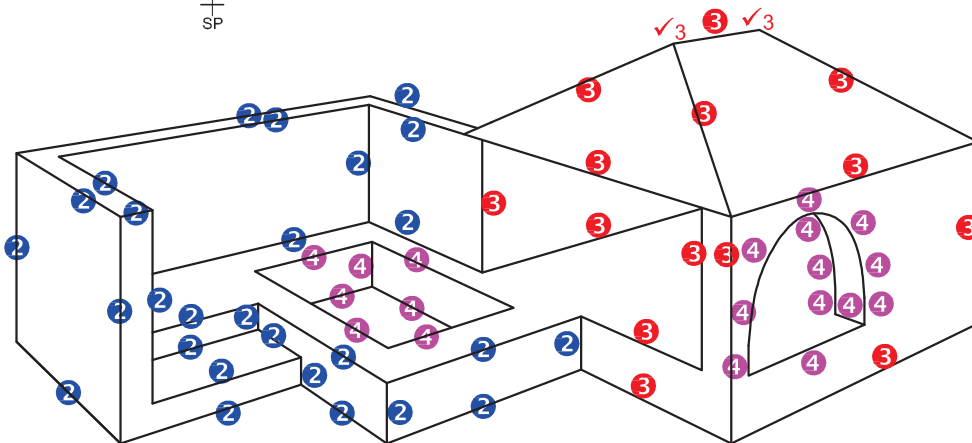

+

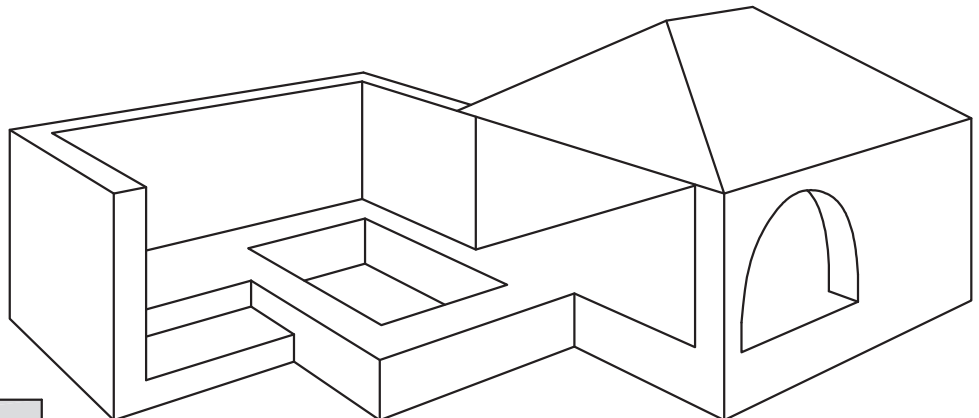

+

ASSESSMENT CRITERIA		
1	CONSTRUCTION + VPs	7
2	WALLS	13½
3	BUILDING + ROOF	9
4	ARCH + CONSTR' + PIT	11½
TOTAL		41

PAPER 1 QUESTION 3
GRADE 12
November 2013
MEMORANDUM

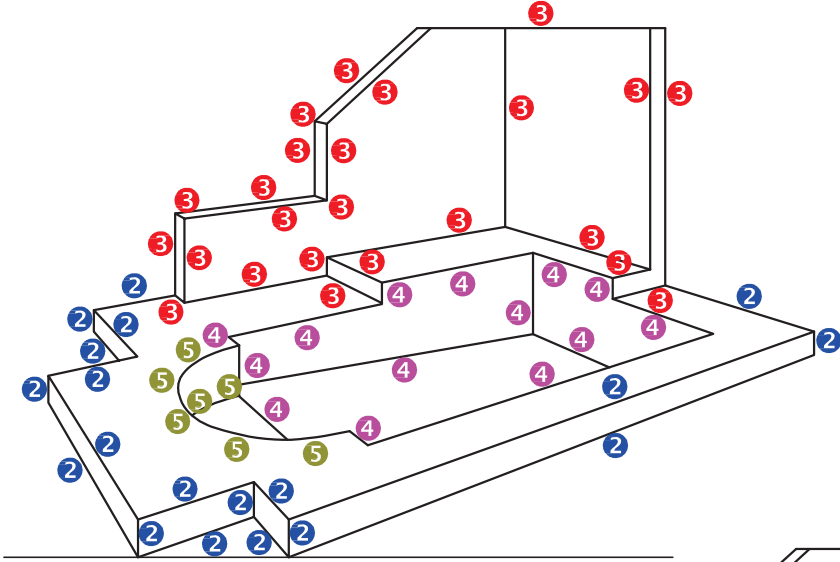
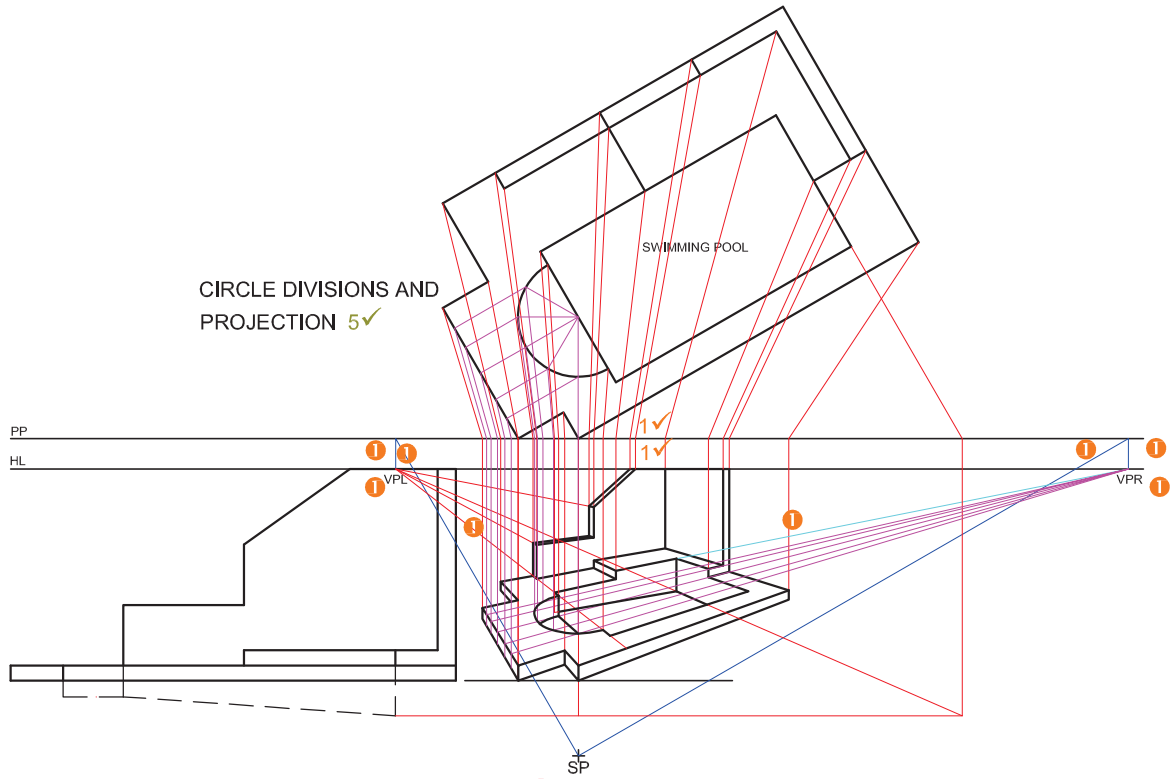

SP

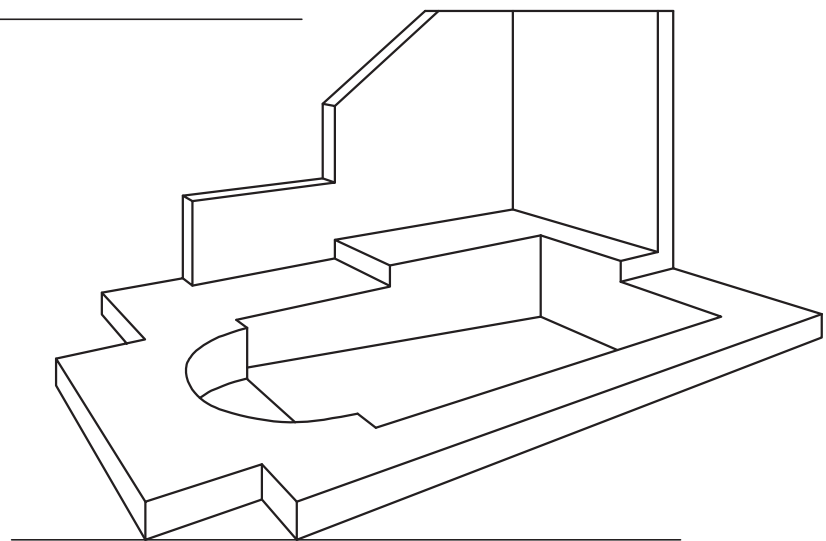

ASSESSMENT CRITERIA		
1	CONSTRUCTION + VPs	6
2	SURROUND	9½
3	WALL + STEP	12
4	SWIMMING POOL	7
5	SEMI-CIRCLE	4½
TOTAL		39

PAPER 1 QUESTION 3
 GRADE 12
 FEB. - MAR. 2013
 MEMORANDUM

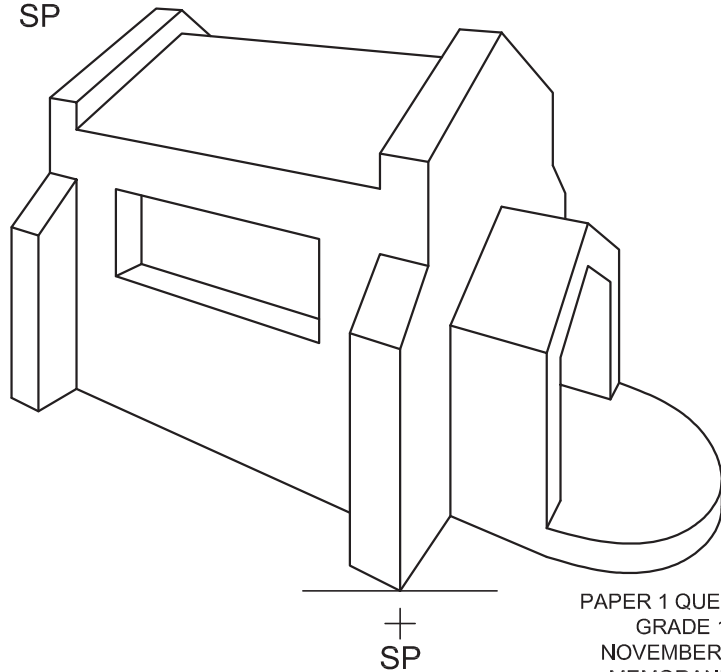
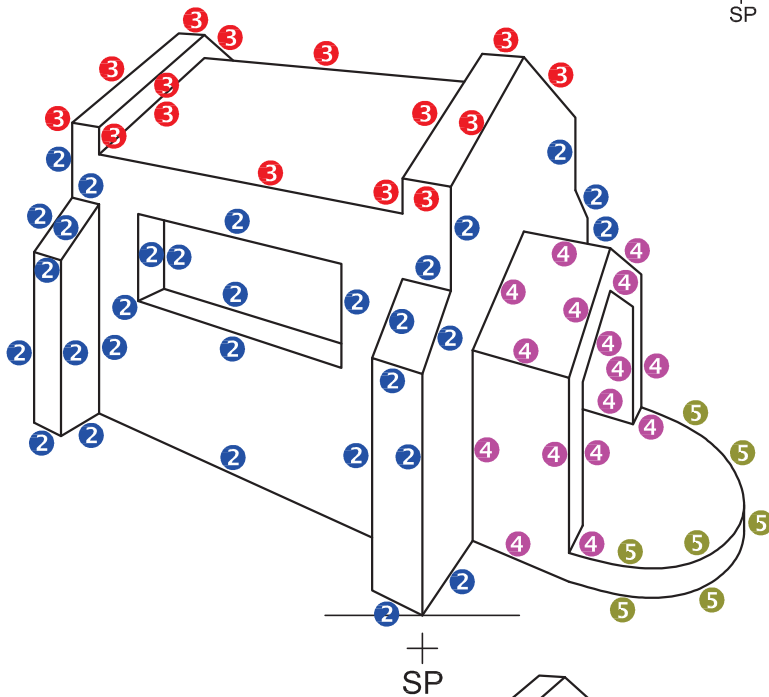
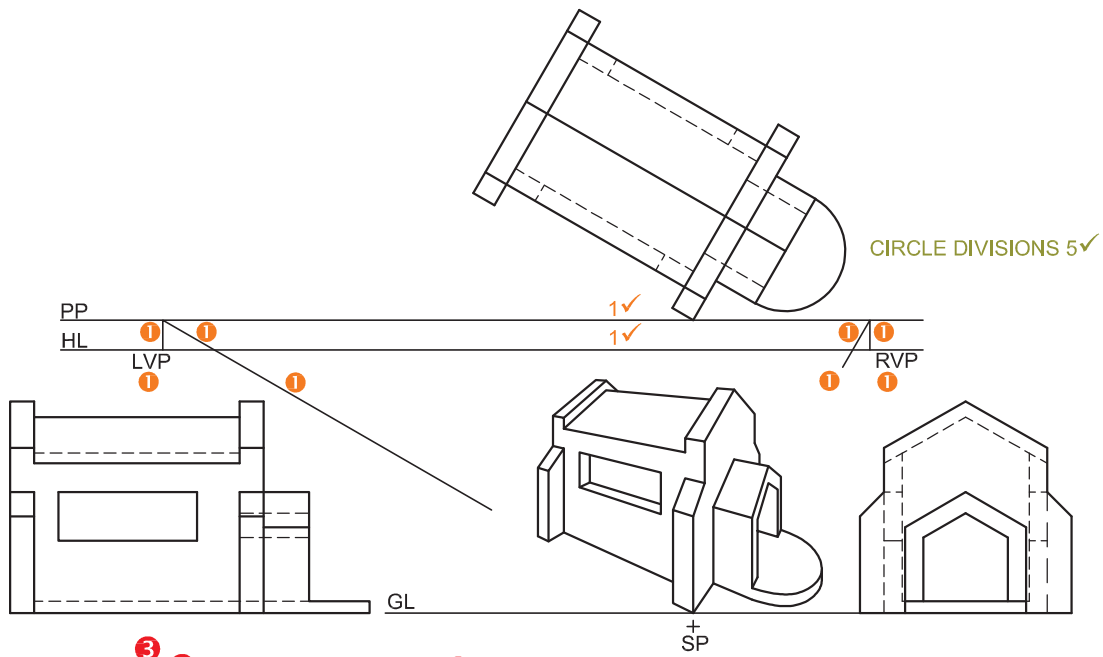

ASSESSMENT CRITERIA		
1	CONSTRUCTION + VPs	6
2	BUILDING + WINDOW	15
3	ROOF	7½
4	ENTRANCE	8
5	SEMICIRCLE	4½
TOTAL		41

PAPER 1 QUESTION 3
 GRADE 12
 NOVEMBER 2012
 MEMORANDUM

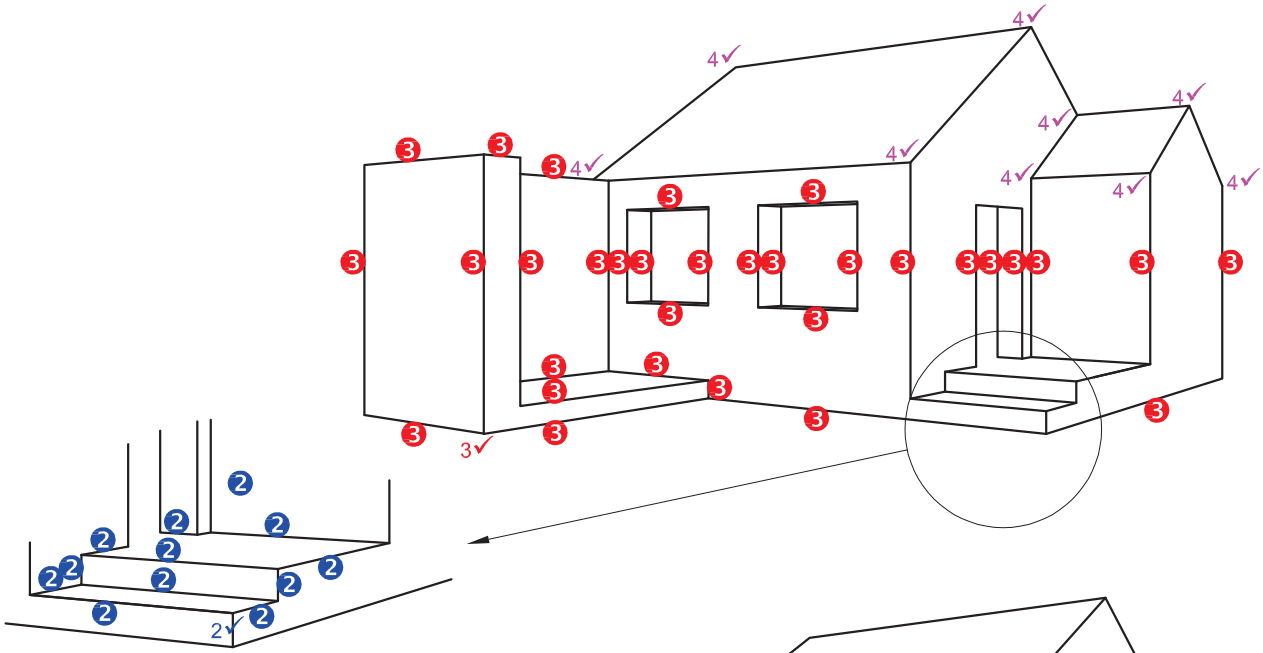
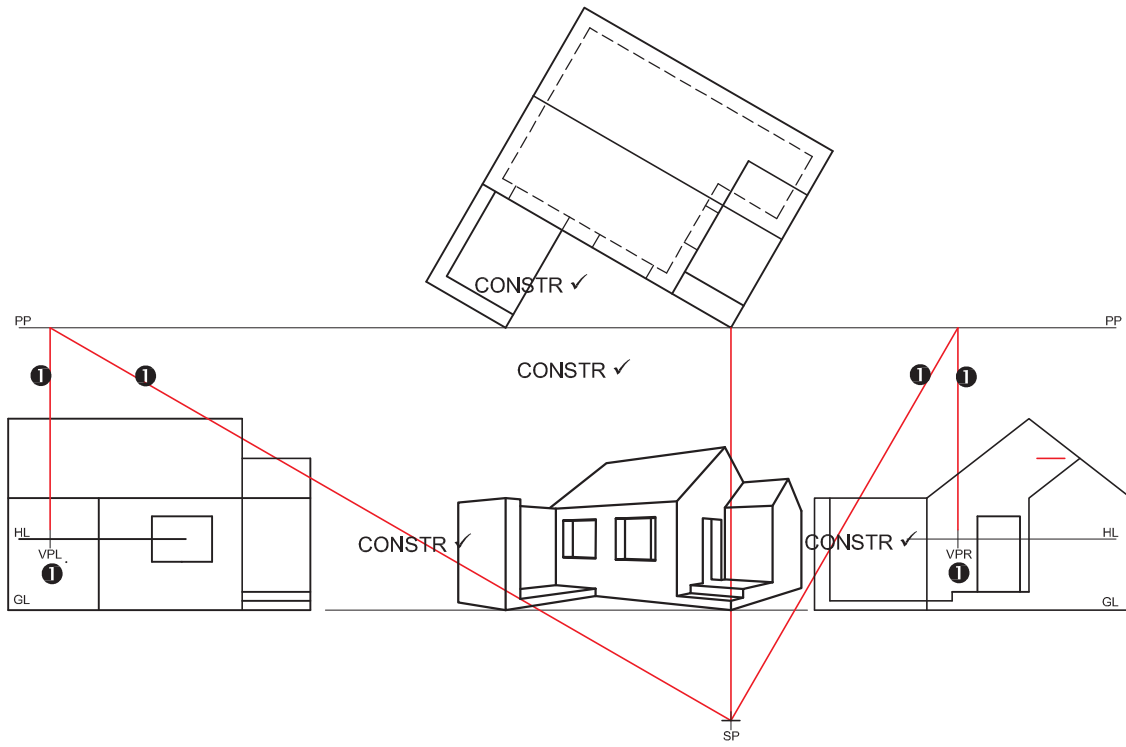

DETAIL OF MARK ALLOCATION FOR STAIRS

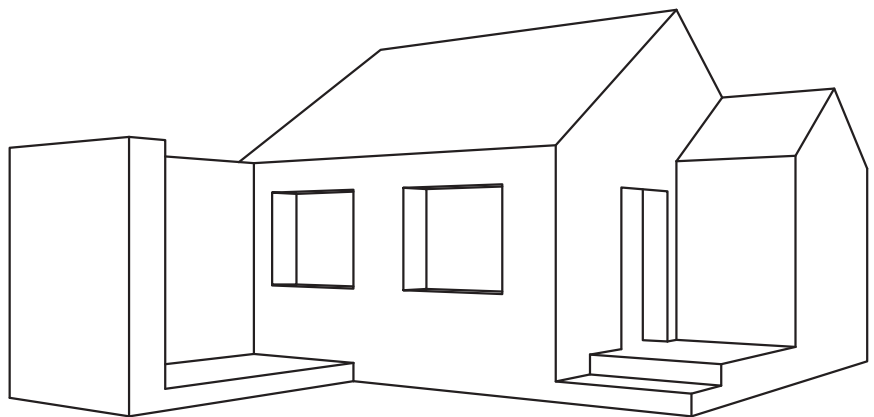

ASSESSMENT CRITERIA		
1	CONSTRUCTION + VPs	7
2	STAIRS	7
3	WALLS + DOOR + WINDOW	17
4	ROOF	9
TOTAL		40

PAPER 1 QUESTION 3
 GRADE 12
 Feb.-Mar. 2012
 MEMORANDUM

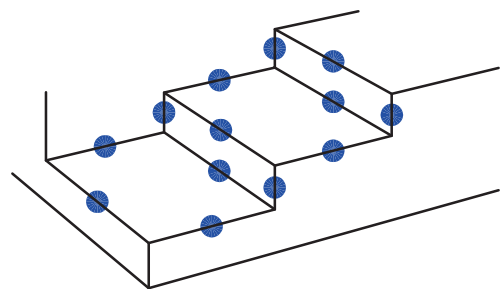
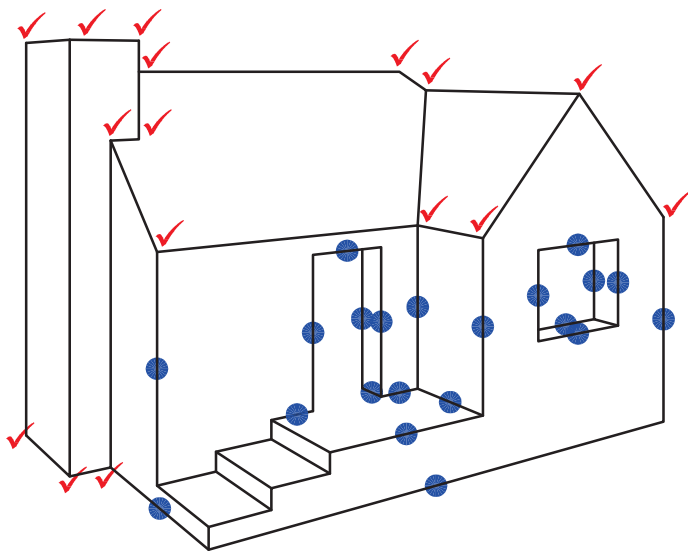
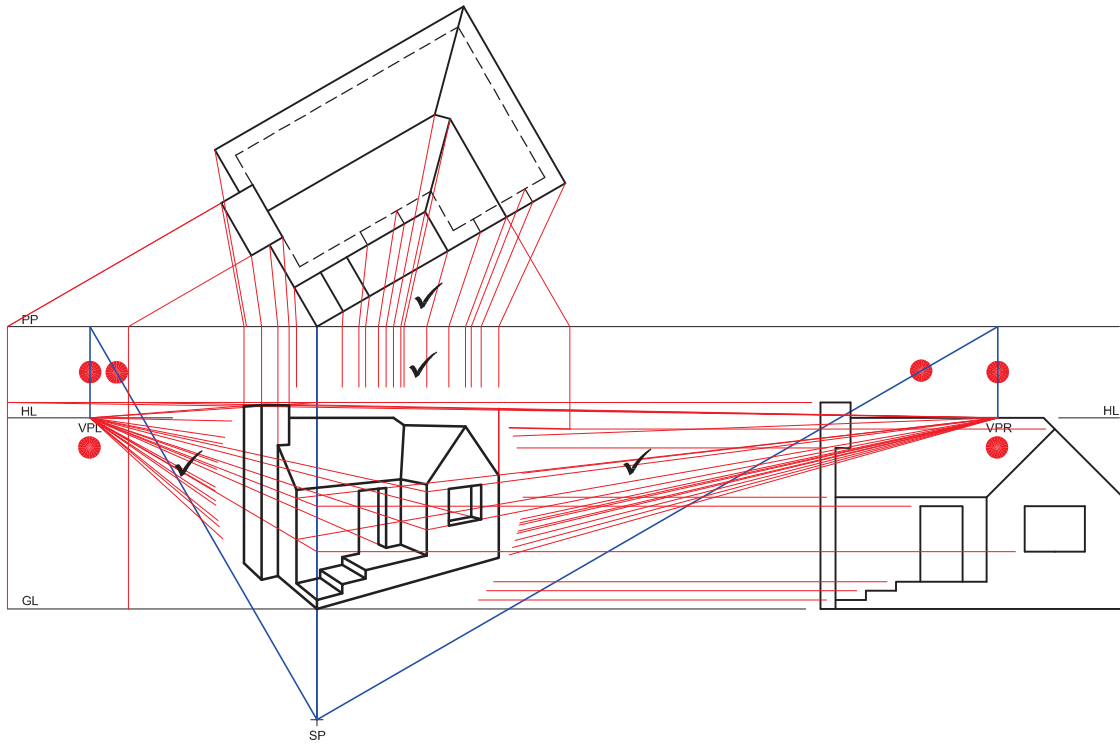

✓ DETAIL OF MARK ALLOCATION FOR STEPS (7)

+

SP

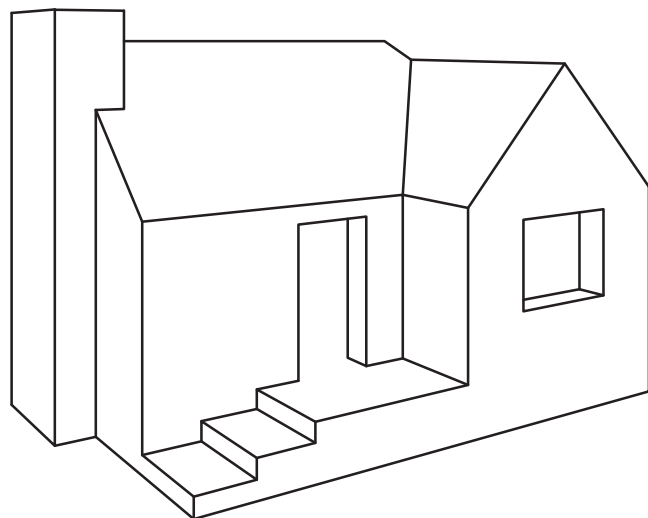

ASSESSMENT CRITERIA	
CONSTRUCTION + VPs	7
BUILDING	18
ROOF + CHIMNEY	16
TOTAL	41

PAPER 1 QUESTION 3
 GRADE 12
 NOVEMBER 2011
 MEMORANDUM

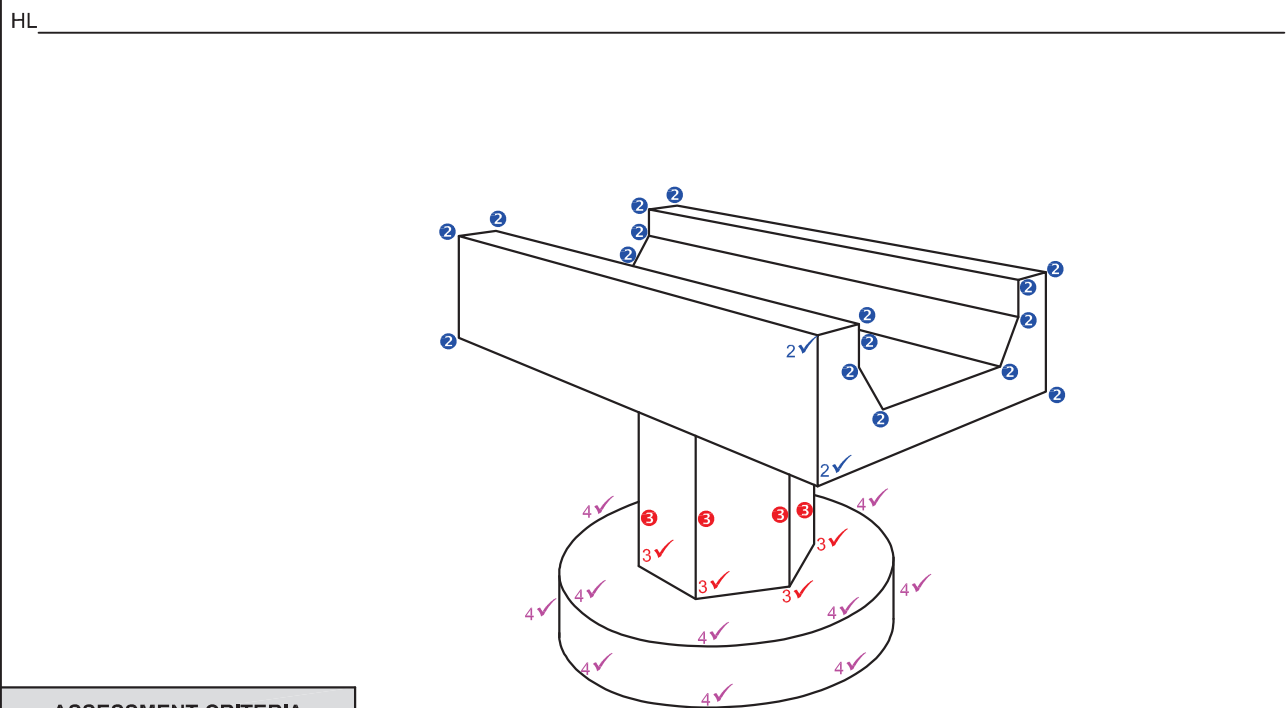
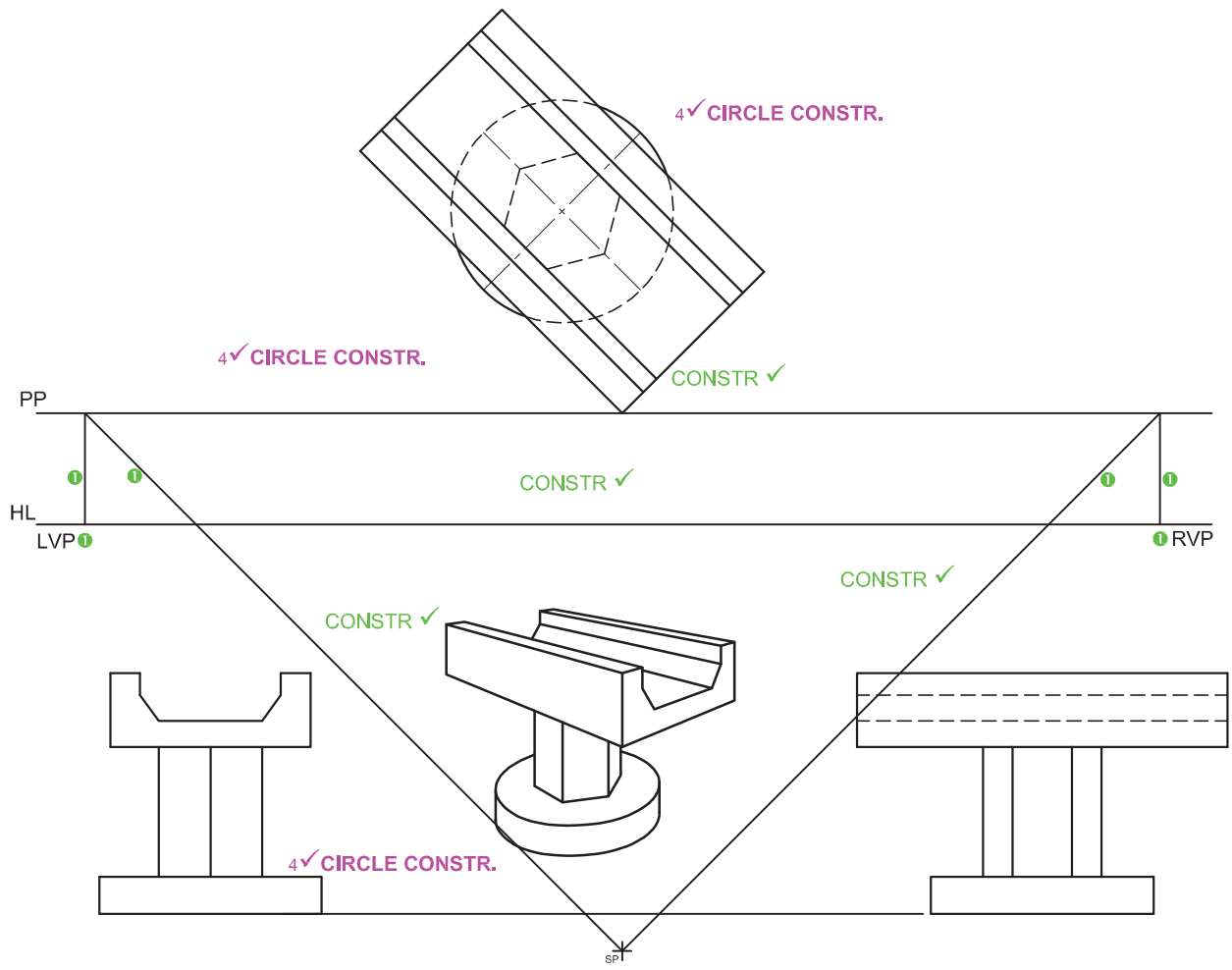

ASSESSMENT CRITERIA	
1. CONSTRUCTION + VPs	7
2. ROAD	10
3. HEXAGONAL PILLAR	6
4. ROUND BASE	13
TOTAL	36

GL

SP↑

PAPER 1 QUESTION 3
 GRADE 12
 FEBRUARY/MARCH 2011
 MEMORANDUM

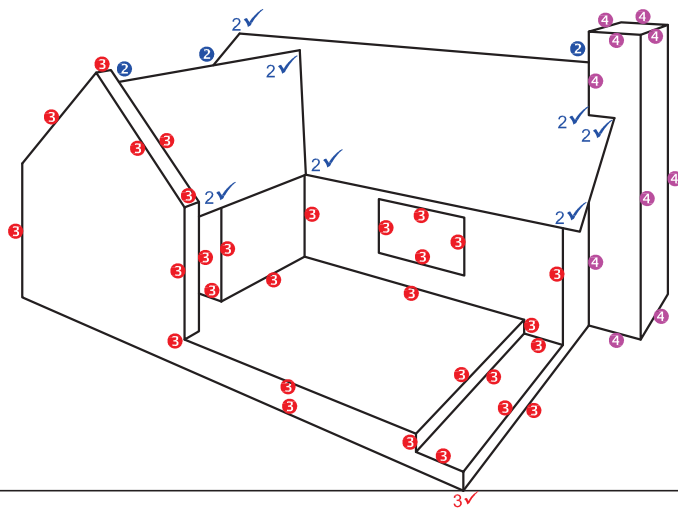
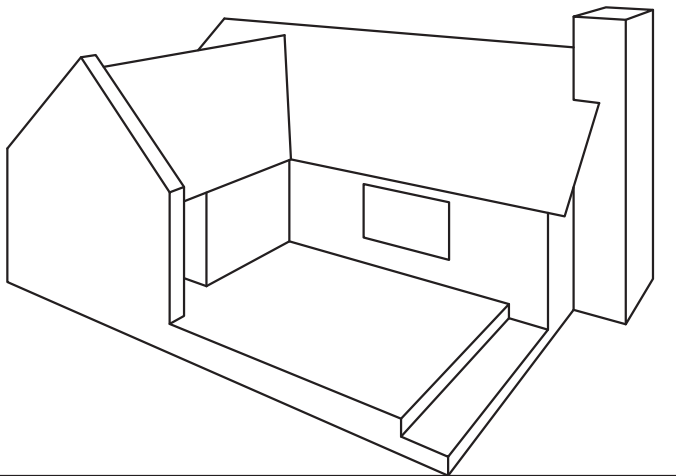
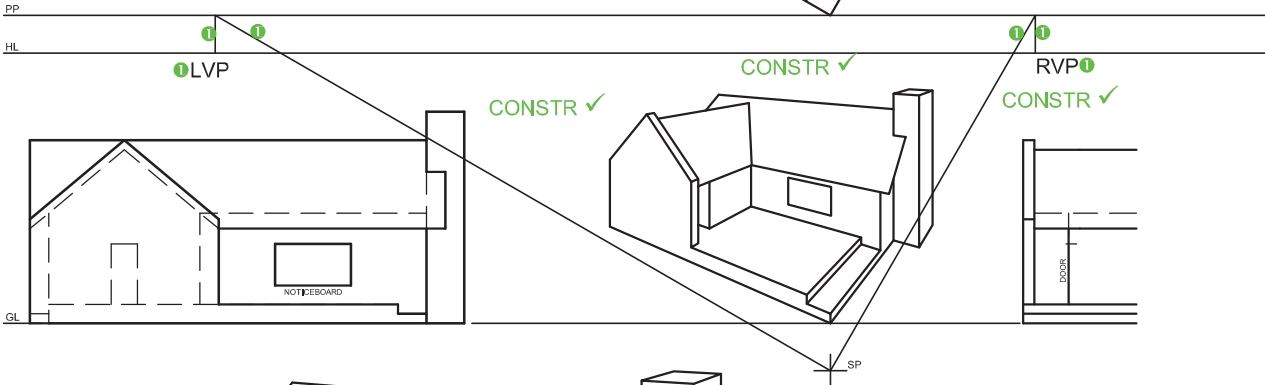
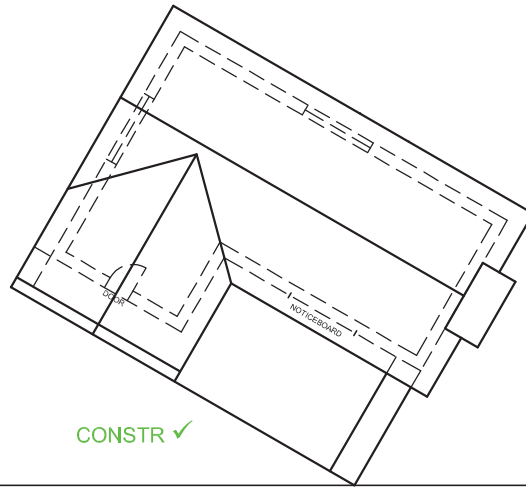

ASSESSMENT CRITERIA	
1. CONSTRUCTION + VPs	7
2. ROOF	8½
3. WALLS + WINDOW	15½
4. CHIMNEY	5
TOTAL	36

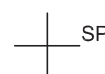

PAPER 1 QUESTION 3
 GRADE 12
 NOVEMBER 2010
 MEMORANDUM

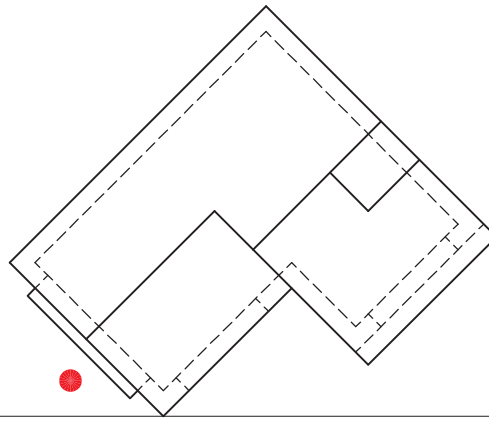

PP

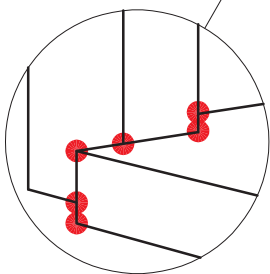
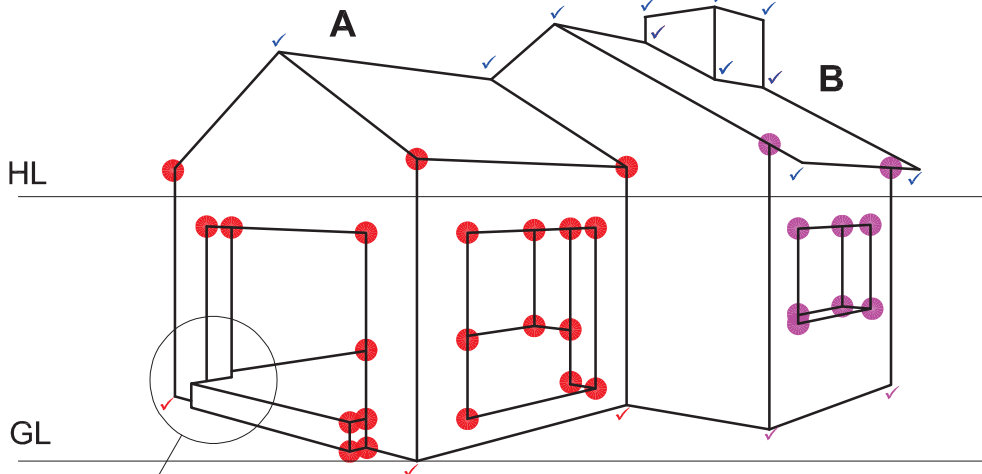
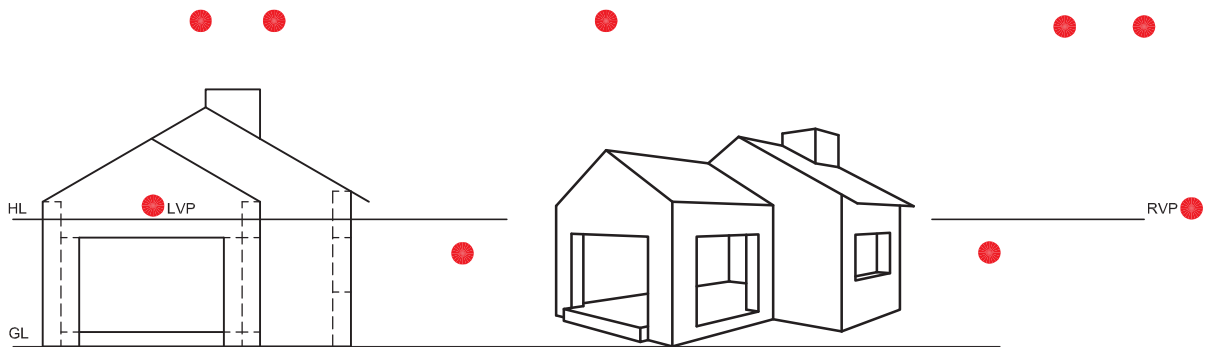

+
SP

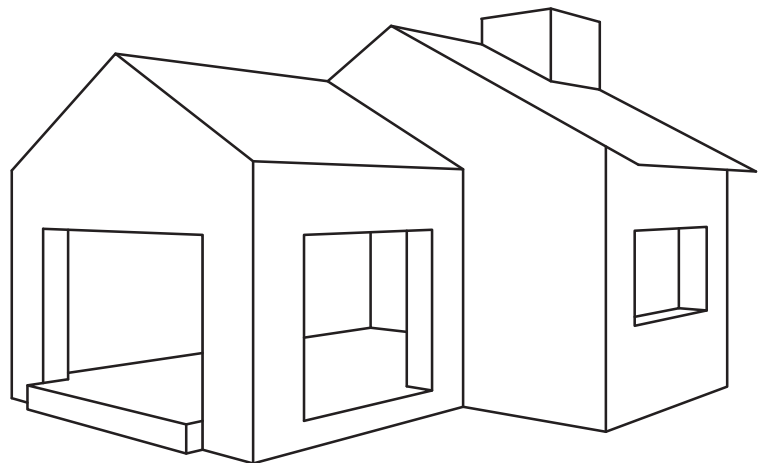

ASSESSMENT CRITERIA

CONSTRUCTION + VPs

PART (A)

PART (B)

ROOF + CHIMNEY

TOTAL

5

16 $\frac{1}{2}$

6 $\frac{1}{2}$

11

39

PAPER 1 QUESTION 3
GRADE 12
FEBRUARY/MARCH 2010
MEMORANDUM

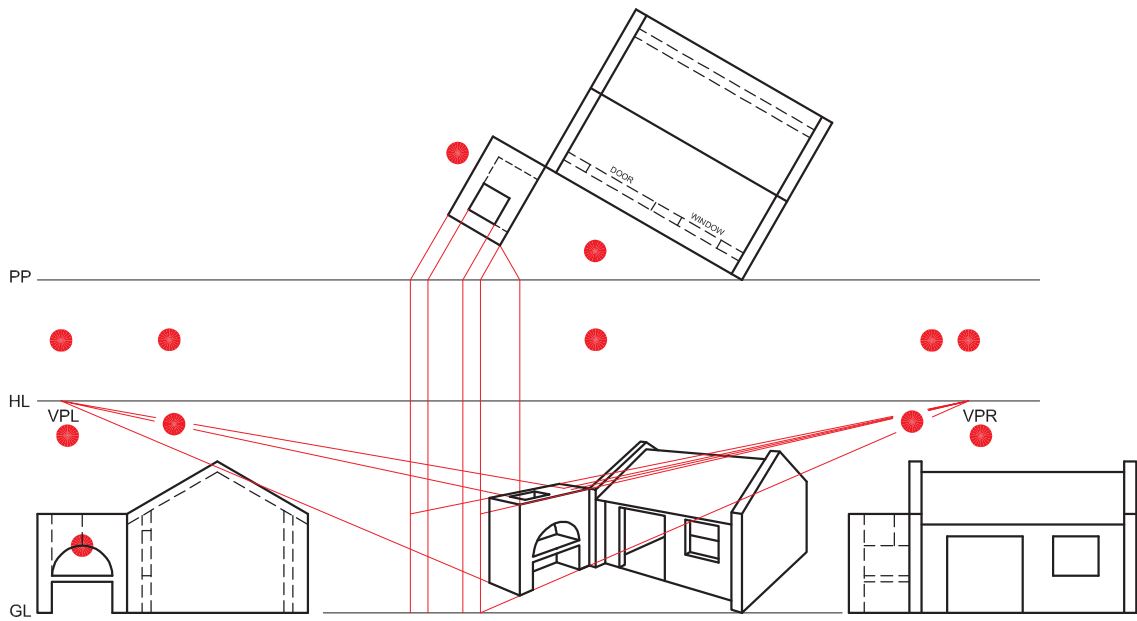

CONSTRUCTION AND VPs 6

+
SP

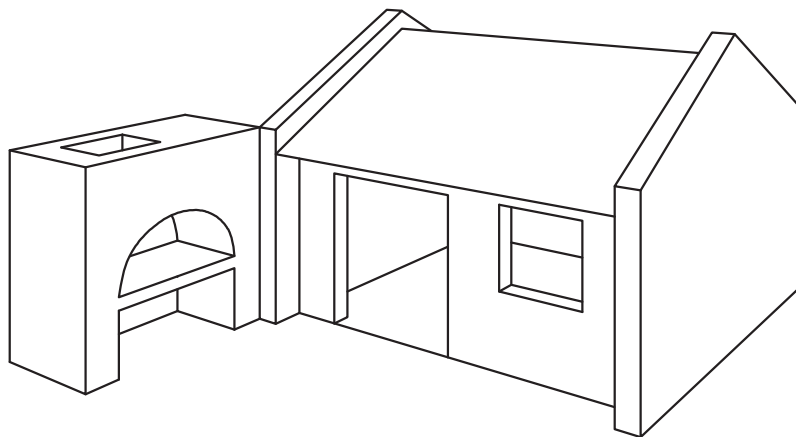

PART A

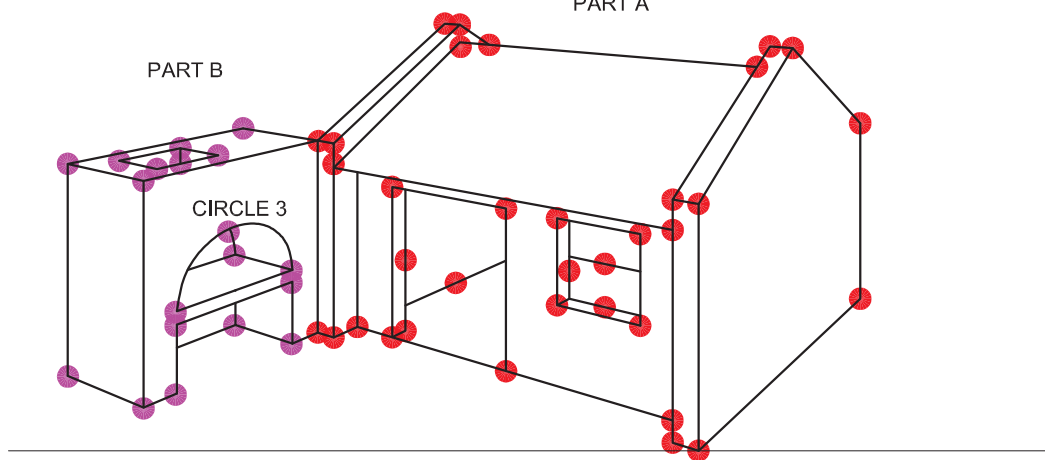

PART B

CIRCLE 3

ASSESSMENT CRITERIA

CONSTRUCTION + VPs	6
DWELLING (PART A)	17½
BRAAI (PART B + CIRCLE)	12½
TOTAL	36

+
SP

PAPER 1 QUESTION 3
GRADE 12 NOVEMBER 2009
MEMORANDUM

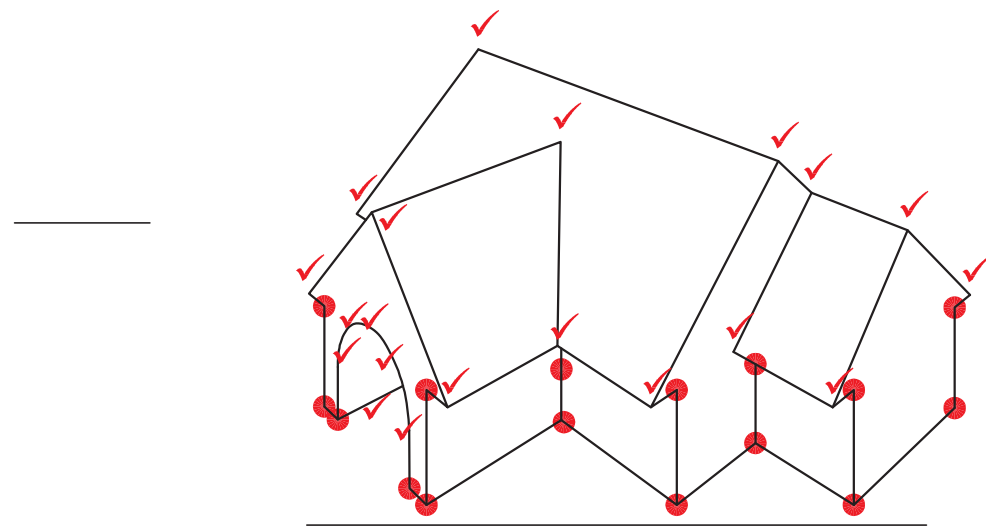
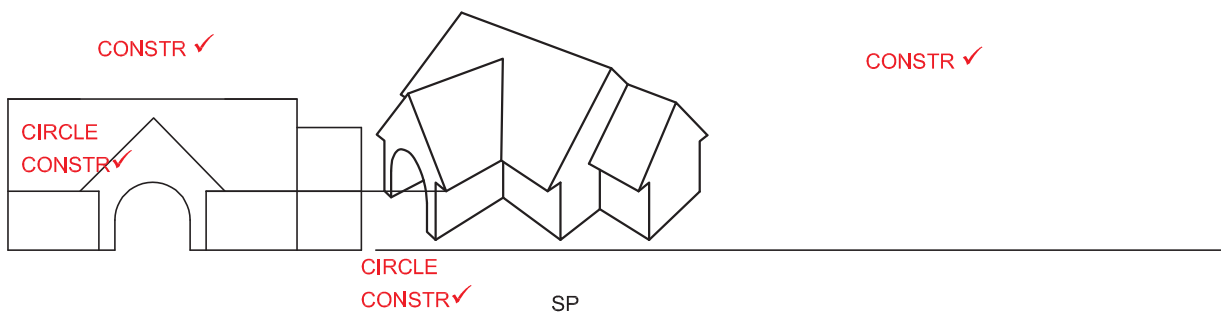
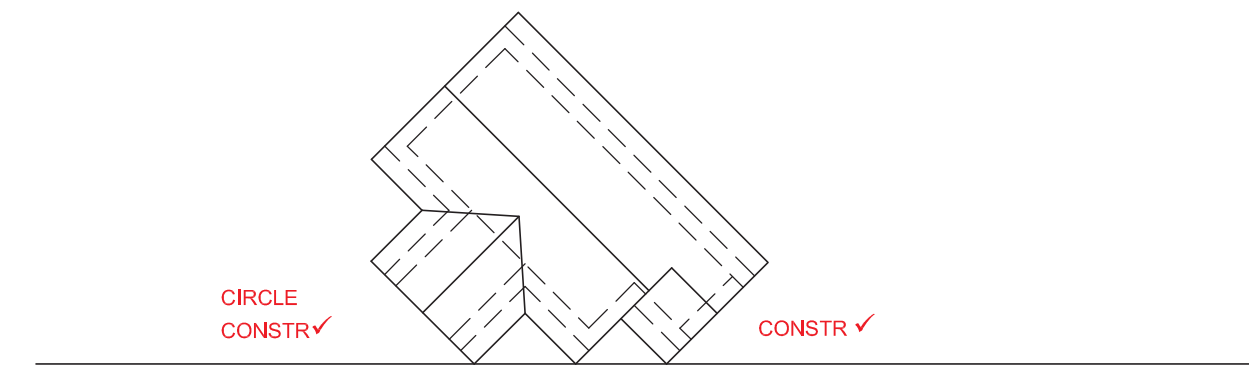

ASSESSMENT CRITERIA

CONSTRUCTION	4
FIND AND LABEL VP'S	4
CIRCLE + CONSTRUCTION	8
ROOF	14
WALLS, DOOR	9
TOTAL	39

SP

PAPER 1 QUESTION 3
 GRADE 12
 FEBRUARY/MARCH 2009
 MEMORANDUM

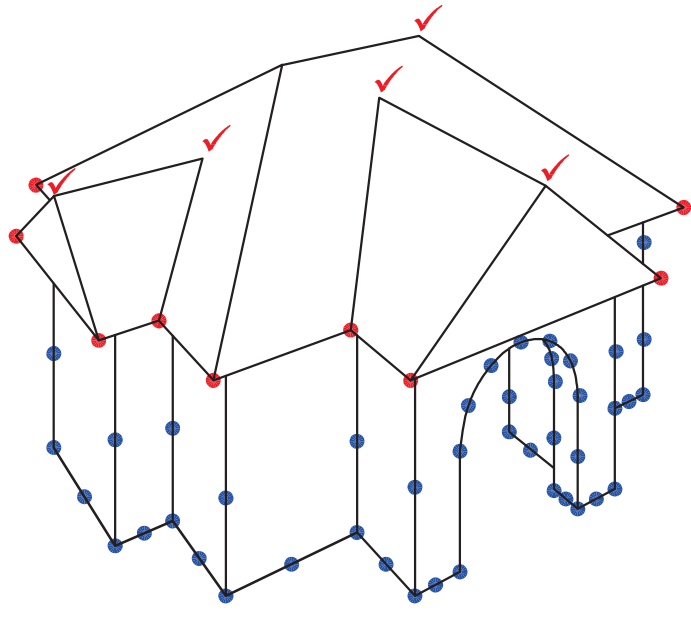
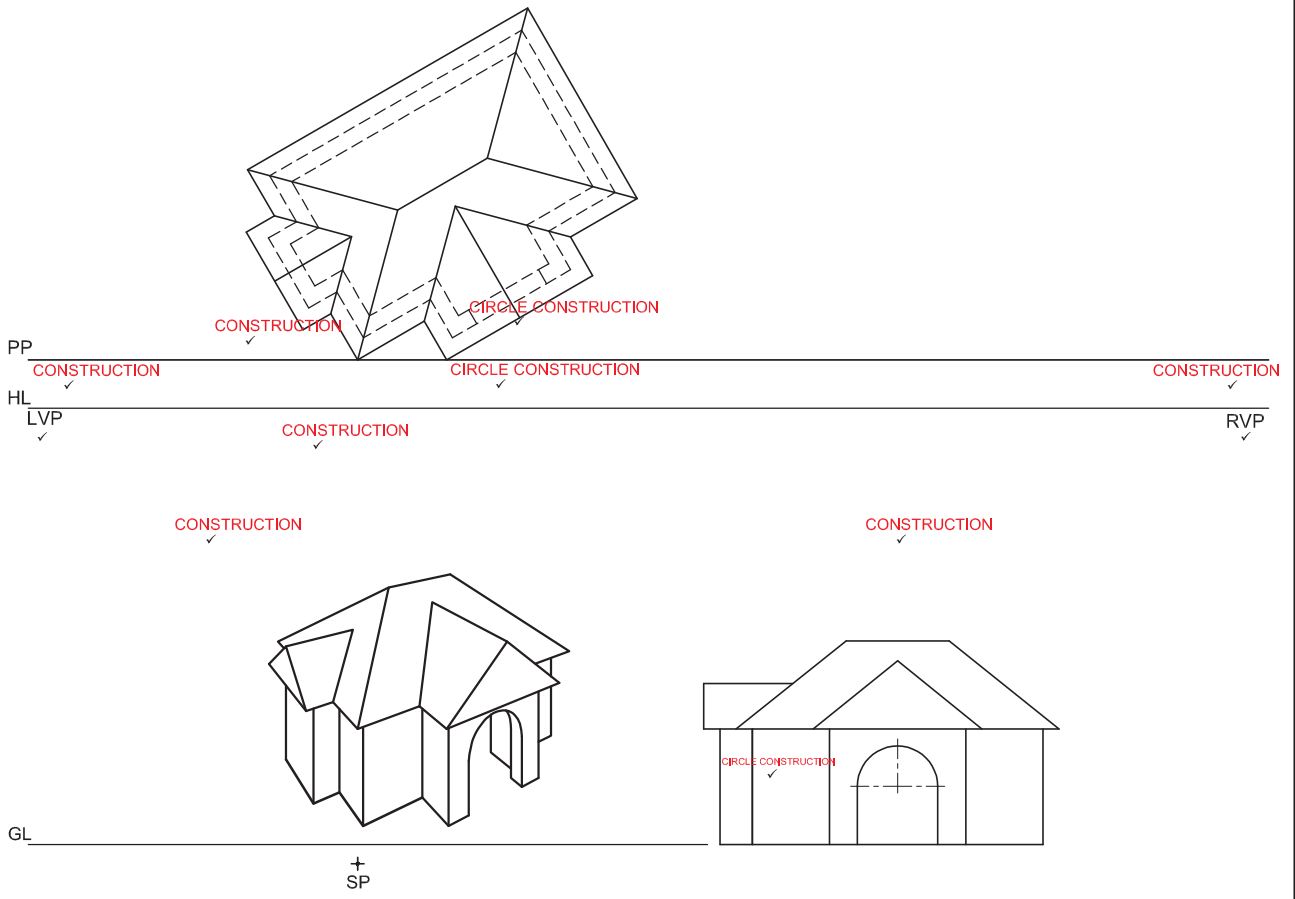

	+
	SP
ASSESSMENT CRITERIA	
CONSTRUCTION	6
LABEL THE VPs	2
CIRCLE CONSTRUCTION	3
ROOF	10
WALLS, DOOR	22
TOTAL	43

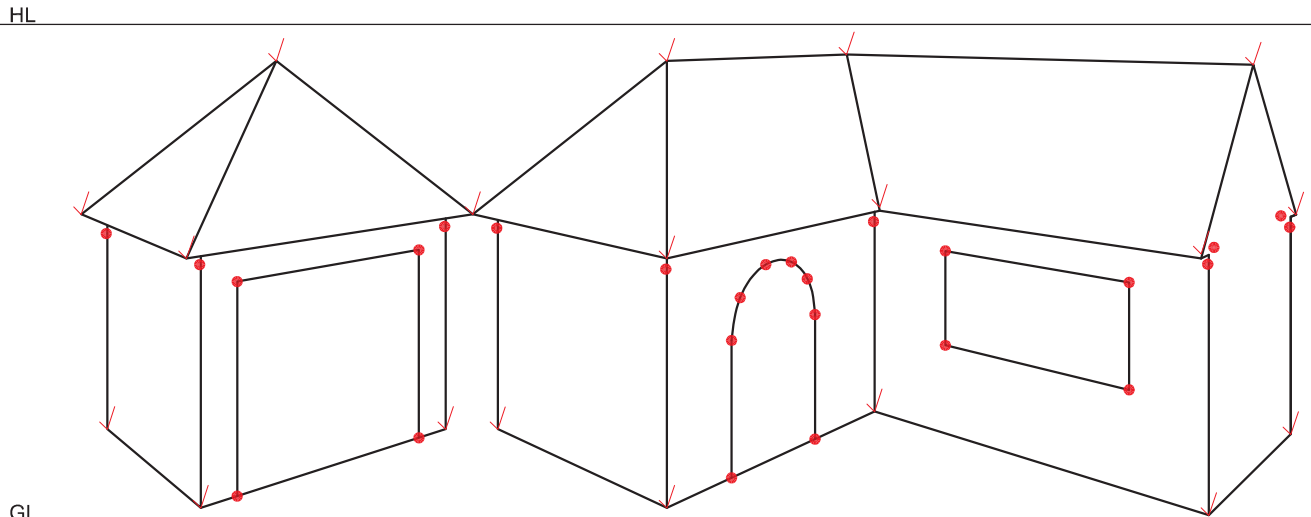
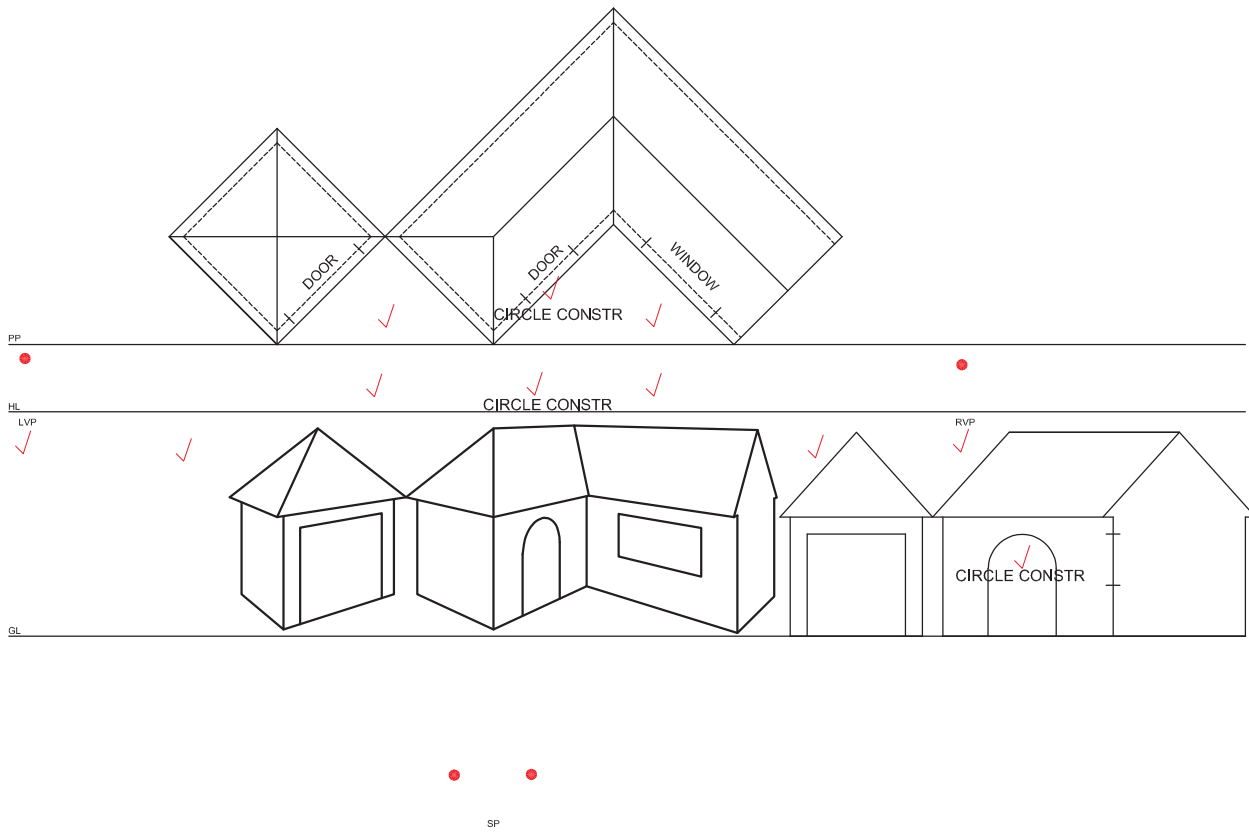

ASSESSMENT CRITERIA

PROJECTION	=	10
CIRCLE CONSTRUCTION	=	3
ROOF	=	11
WALLS, WINDOW, DOORS	=	21
TOTAL		45

SP

2008 GRADE 12
PAPER 1
EXEMPLAR
QUESTION 3
MEMORANDUM