

ASSESSMENT CRITERIA		
1	SECTIONAL TOP VIEW	15 ½
2	FRONT VIEW	8 ½
3	SECTIONAL LEFT VIEW	14
TOTAL		38

PAPER 1 QUESTION 2
 GRADE 12
 NOVEMBER 2023
 MARKING GUIDELINES

START AT AB 4

4 EQUAL SPACES 4

NOT REQUIRED

10

CENTRE POINT

AUXILIARY VIEW CORRECTLY ROTATED

ASSESSMENT CRITERIA

ASSESSMENT CRITERIA	6 1/2
1 TOP VIEW	6 1/2
2 FRONT VIEW	11 1/2
3 LEFT VIEW	12 1/2
4 DEVELOPMENT	7 1/2
TOTAL	38

PAPER 1 QUESTION 2
GRADE 12
2023
MARKING GUIDELINES

CONSTRUCTION SQUARE @ 45° ✓ 1

CONSTRUCTION SIZE 37 mm ✓ 2
SHAPE 72° ✓ 2

ASSESSMENT CRITERIA	
1	FRONT VIEW
2	SECTIONAL TOP VIEW
3	SECTIONAL RIGHT VIEW
SUBTOTAL	

ASSESSMENT CRITERIA

1 FRONT VIEW 7

2 SECTIONAL TOP VIEW 12 1/2

3 SECTIONAL RIGHT VIEW 10

SUBTOTAL 29 1/2

PAPER 1 QUESTION 2
GRADE 12
NOVEMBER 2022
MARKING GUIDELINES

Turn over for true shape

TRUE SHAPE
 ANY RECOGNISED METHOD ✓4

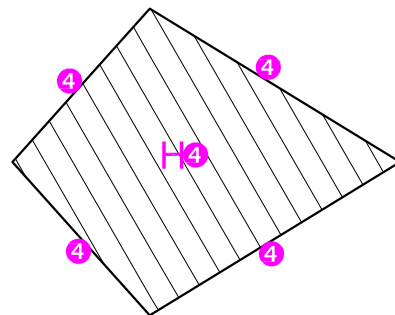
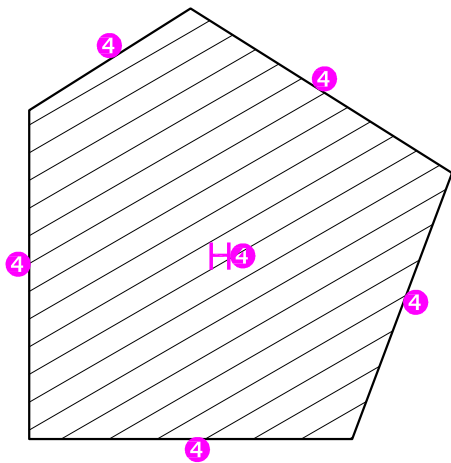

5. NOTE ON CORRECT HATCHING
 DIFFERENT DIRECTIONS ✓5

ASSESSMENT CRITERIA		
4	TRUE SHAPE	6 ½
5	CORRECT HATCHING	1
SUBTOTAL		7 ½

PAPER 1 QUESTION 2
 GRADE 12
 NOVEMBER 2022
 MARKING GUIDELINES

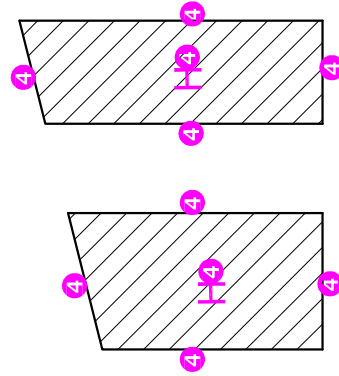
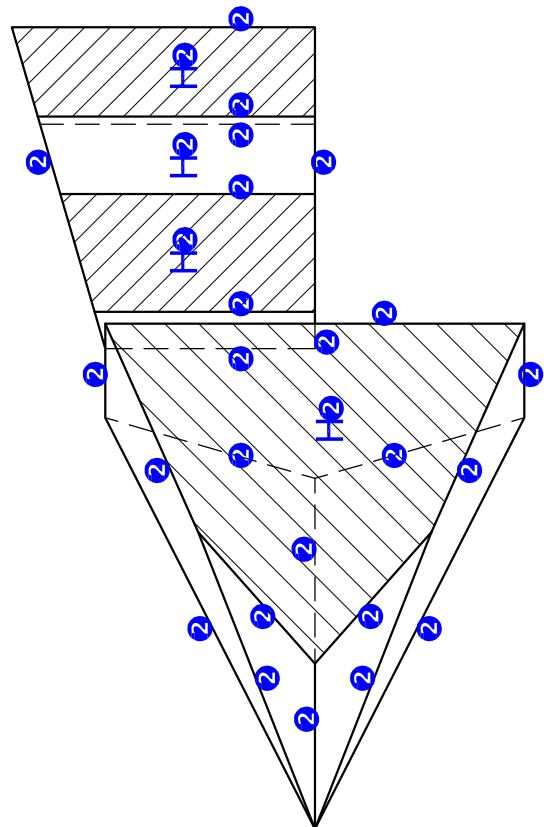
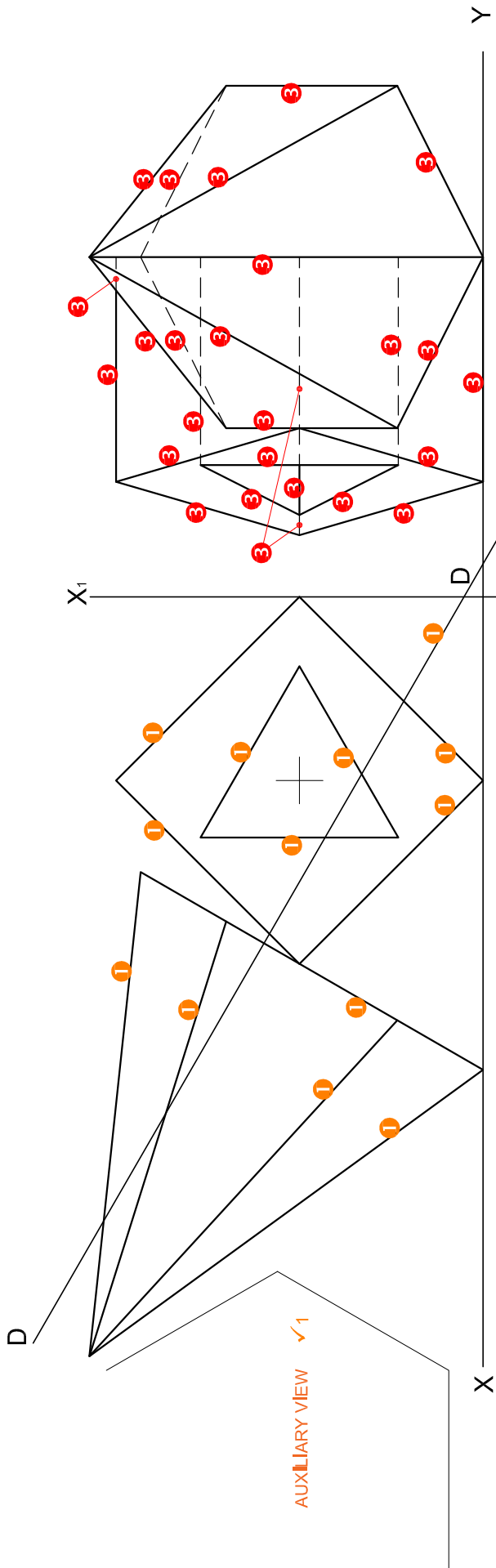

ASSESSMENT CRITERIA	
1	FRONT VIEW 7 ½
2	SECTIONED TOP VIEW 14
3	LEFT VIEW 12 ½
4	TRUE SHAPE 6
TOTAL 40	

4. TRUE SHAPE ANY RECOGNIZED METHOD ✓4

PAPER 1 QUESTION 2
GRADE 12
2022
MARKING GUIDELINES

ASSESSMENT CRITERIA	
1	TOP VIEW 6
2	RIGHT VIEW 5
3	FRONT VIEW 16 $\frac{1}{2}$

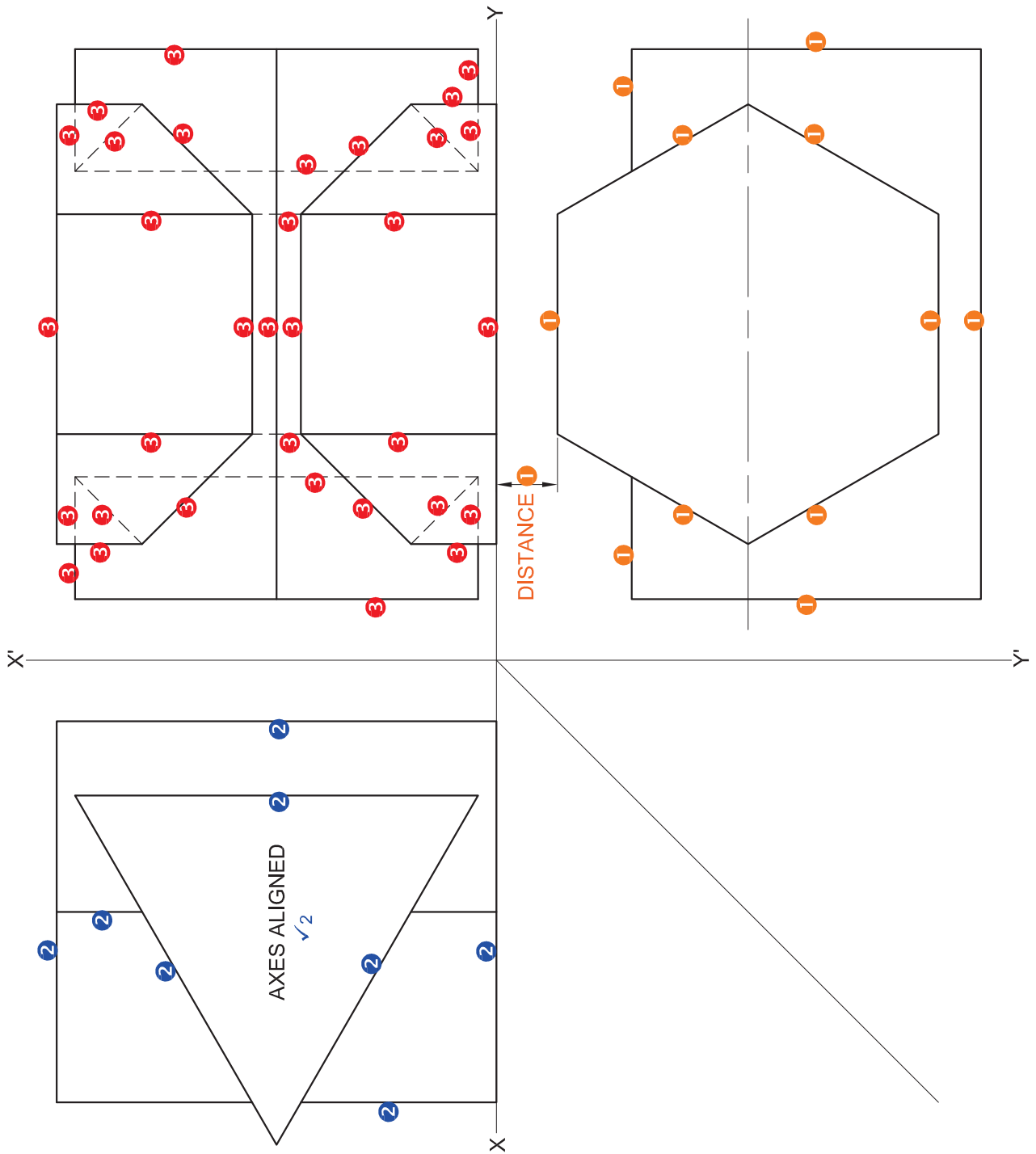

PAPER 1 QUESTION 2
 GRADE 12
 NOVEMBER 2021
 MARKING GUIDELINE

ASSESSMENT CRITERIA	
4	DEVELOPMENT 10 $\frac{1}{2}$
TOTAL 38	

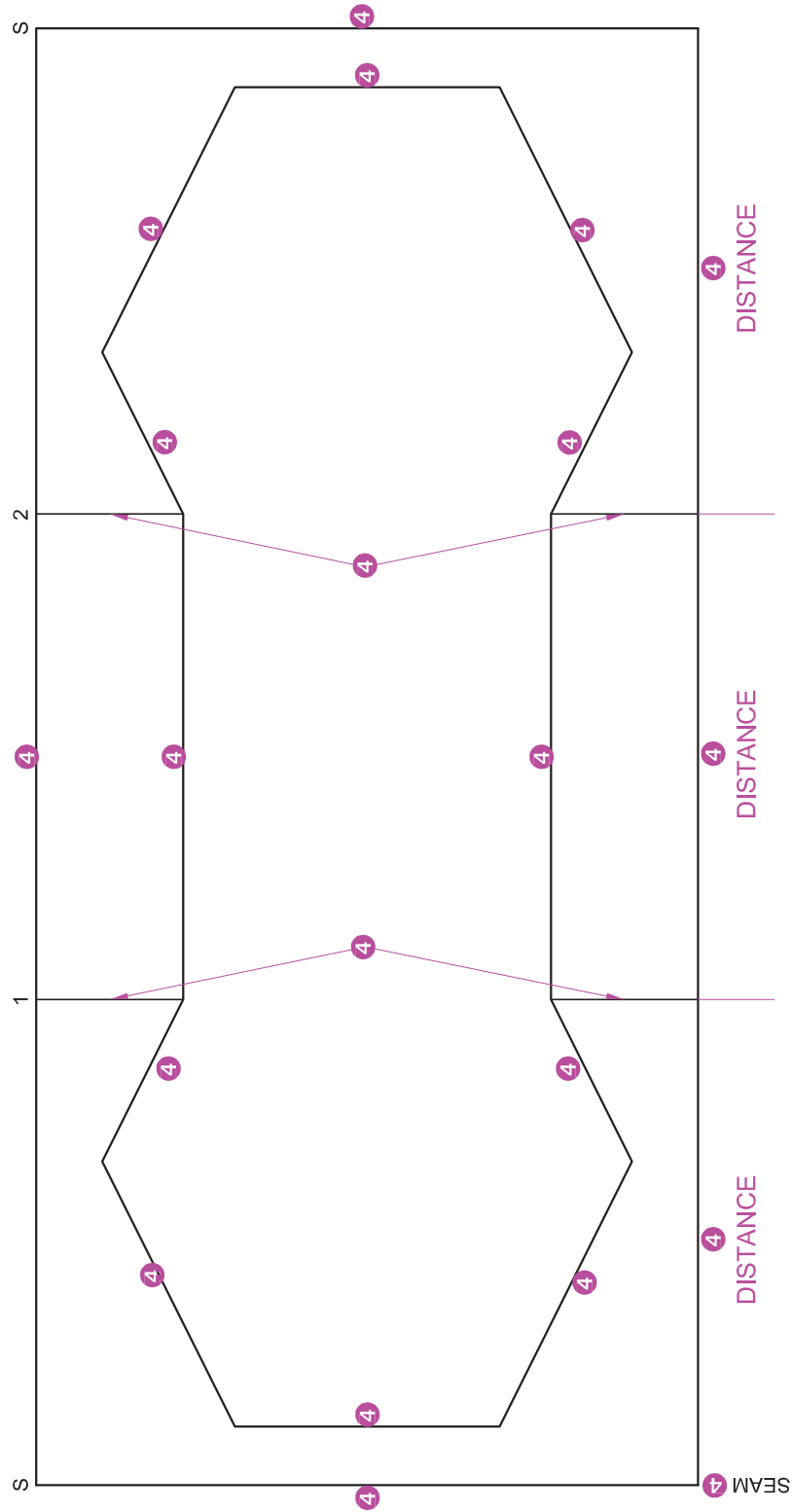

PAPER 1 QUESTION 2
 GRADE 12
 NOVEMBER 2021
 MARKING GUIDELINE

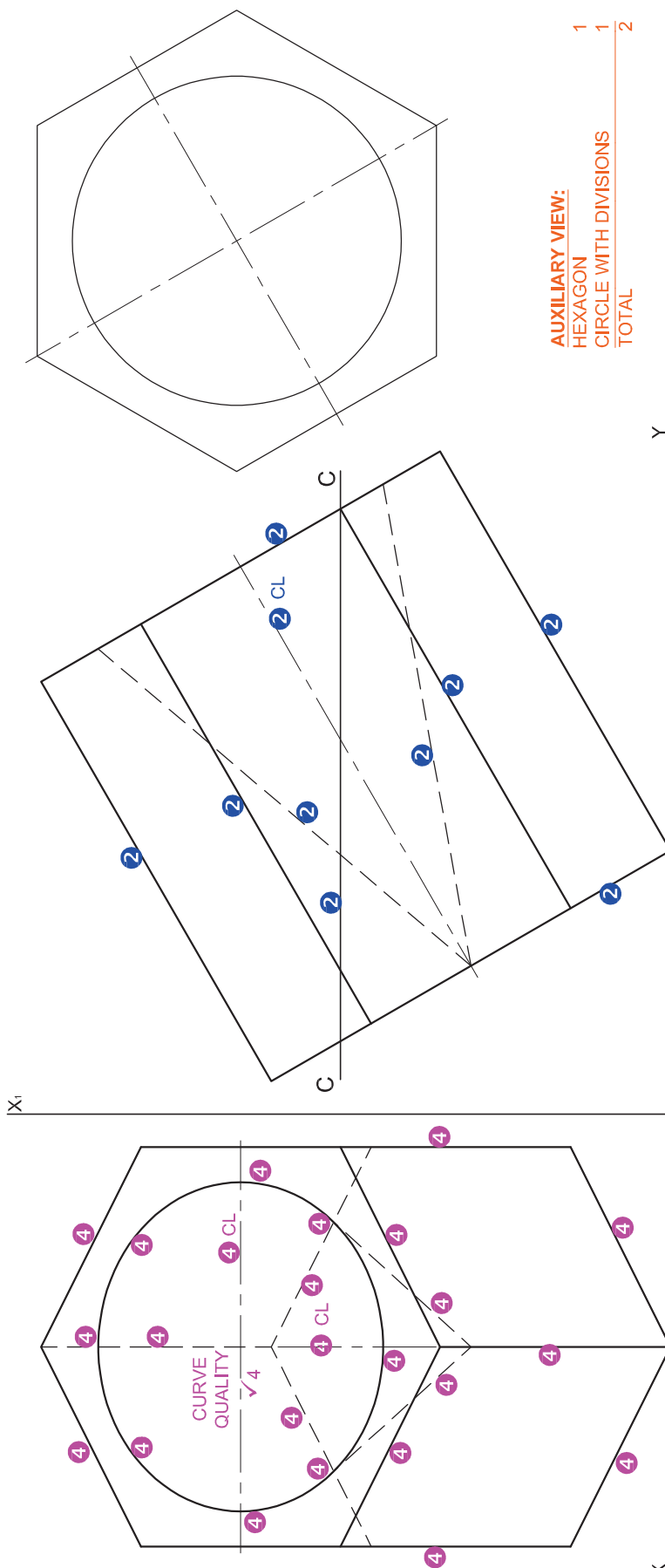

AUXILIARY VIEW:
 HEXAGON 1
 CIRCLE WITH DIVISIONS 1
 TOTAL 2

ANY RECOGNIZED METHOD CAN BE USED

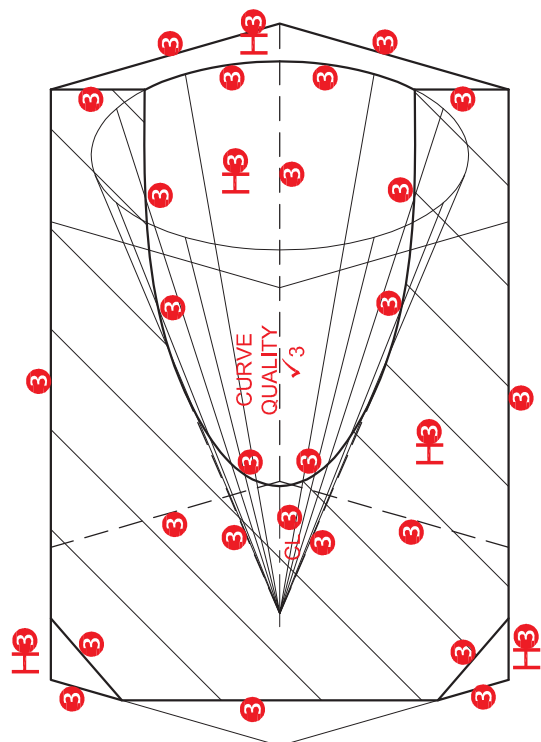

ASSESSMENT CRITERIA	
1	AUXILIARY VIEW 2
2	FRONT VIEW 5
3	SECTIONAL TOP VIEW 16
4	RIGHT VIEW 13
TOTAL 36	

PAPER 1 QUESTION 2
 GRADE 12
 2021
 MARKING GUIDELINES

2. CONSTRUCTION
 HEXAGON 1
 ROTATION 1
 TOTAL 2

3. TRUE SHAPE
 ANY RECOGNIZED METHOD 1

ASSESSMENT CRITERIA	
1	FRONT VIEW 7½
2	SECTIONAL TOP VIEW + CONSTRUCTION 13½
3	SECTIONAL RIGHT VIEW 11½
4	TRUE SHAPE 5½
TOTAL 38	

PAPER 1 QUESTION 2
 GRADE 12
 NOVEMBER 2019
 MARKING GUIDELINES

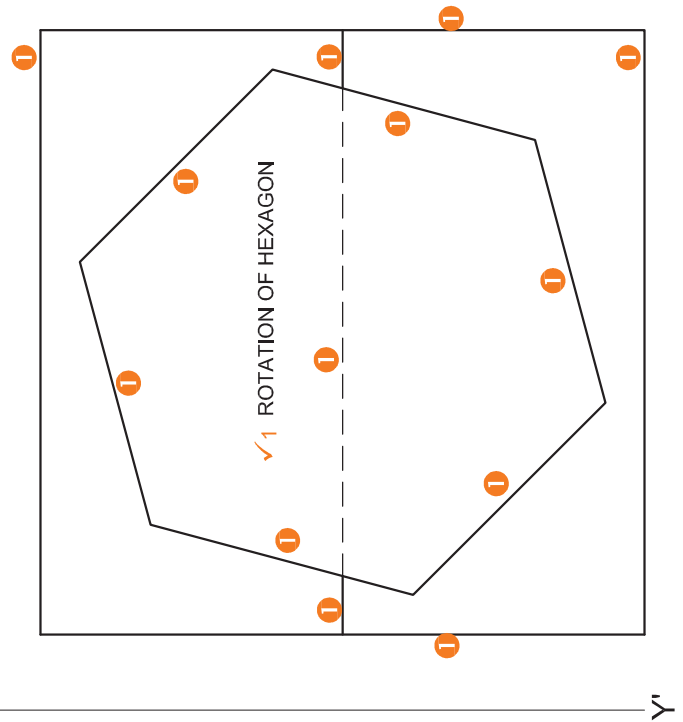
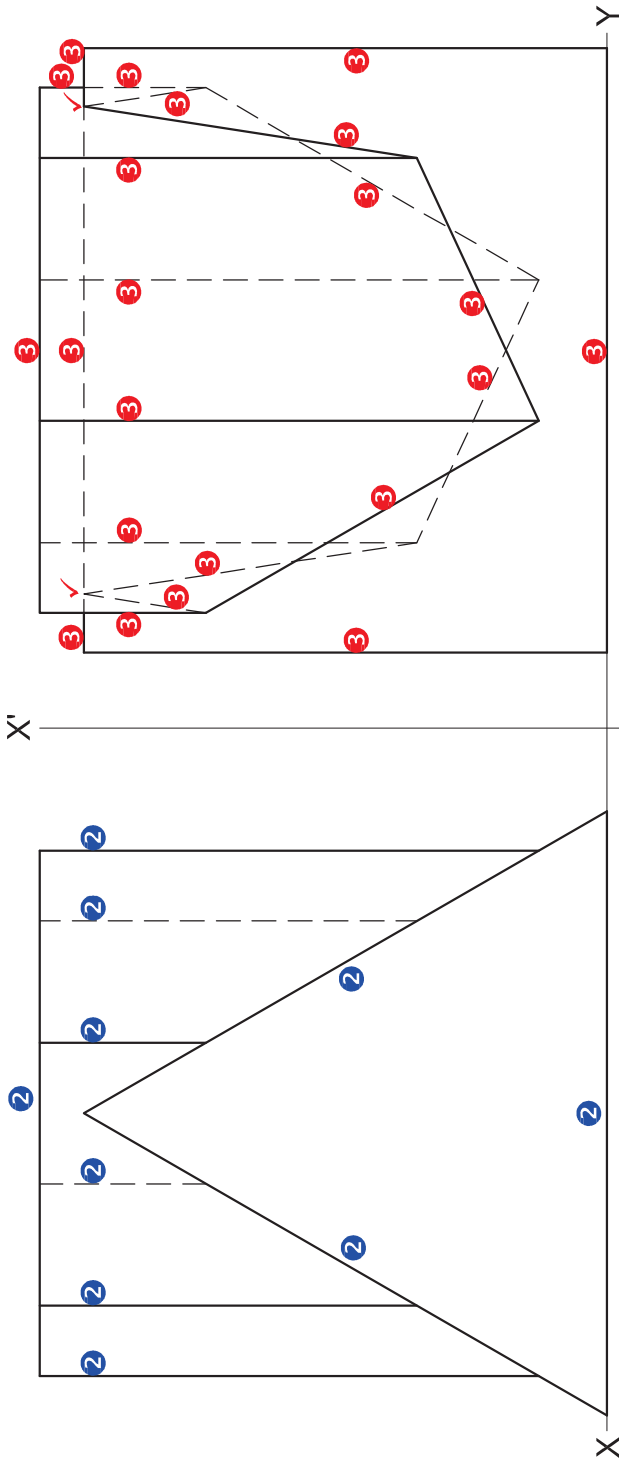

ASSESSMENT CRITERIA	
1	TOP VIEW
2	RIGHT VIEW
3	FRONT VIEW
4	DEVELOPMENT
TOTAL	

PAPER 1 QUESTION 2
 GRADE 12
 NOVEMBER 2019
 MARKING GUIDELINES

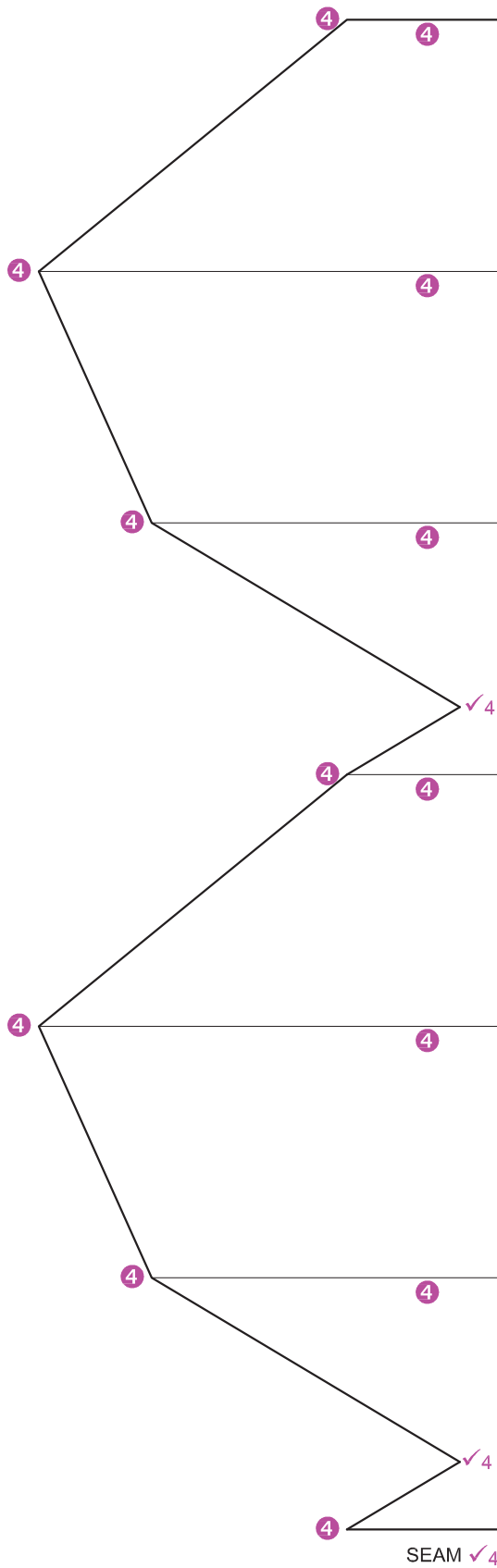

✓ 4 SIX EQUAL SPACES
✓ 4 BASE LINE

PAPER 1 QUESTION 2
GRADE 12
NOVEMBER 2019
MARKING GUIDELINES

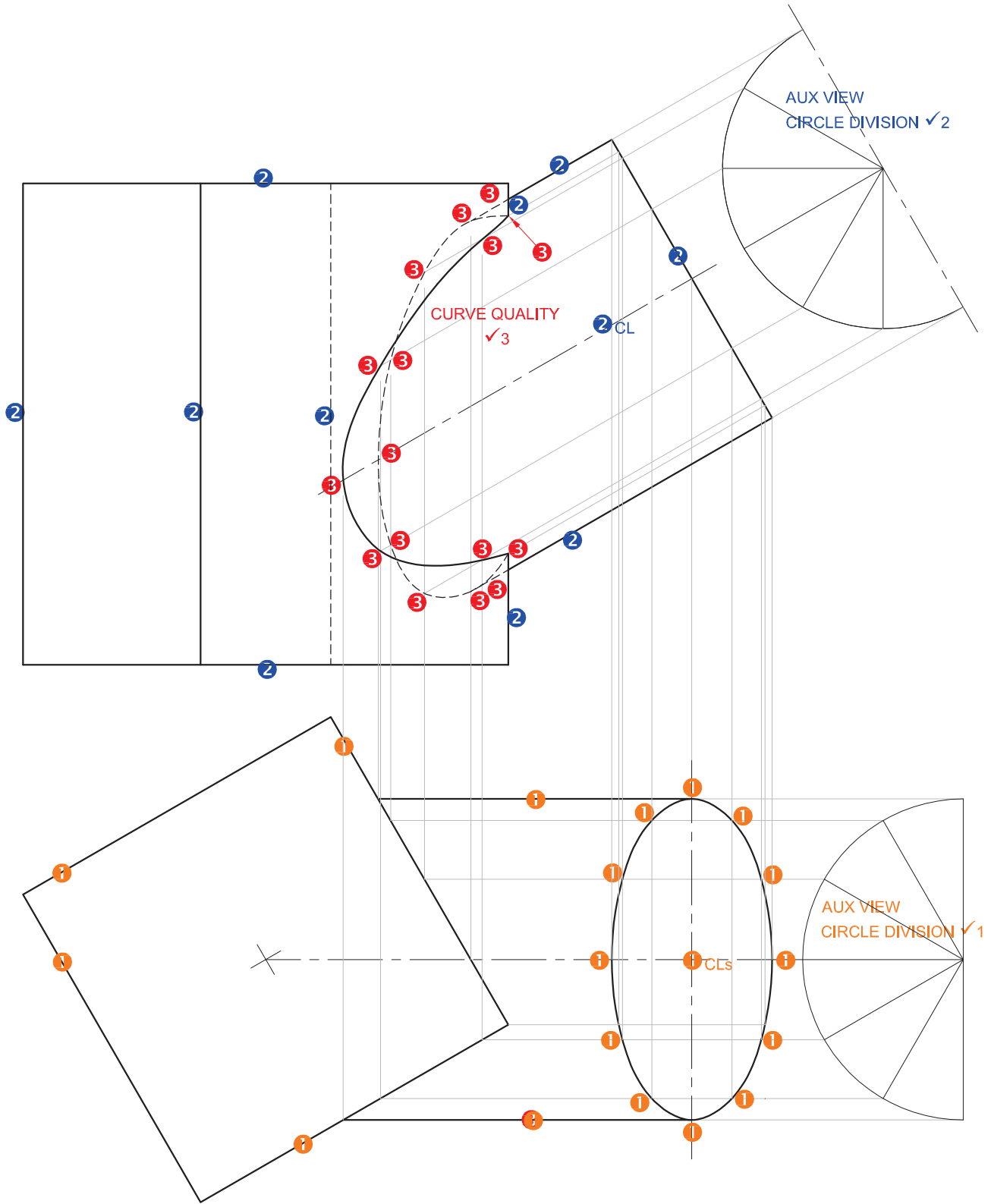

NOTE:
THE DEVELOPMENT AND
ASSESSMENT TABLE IS ON
PAGE 4

APPROVED
PAPER 1 QUESTION 2
GRADE 12
SC/NSC 2019
MARKING GUIDELINES

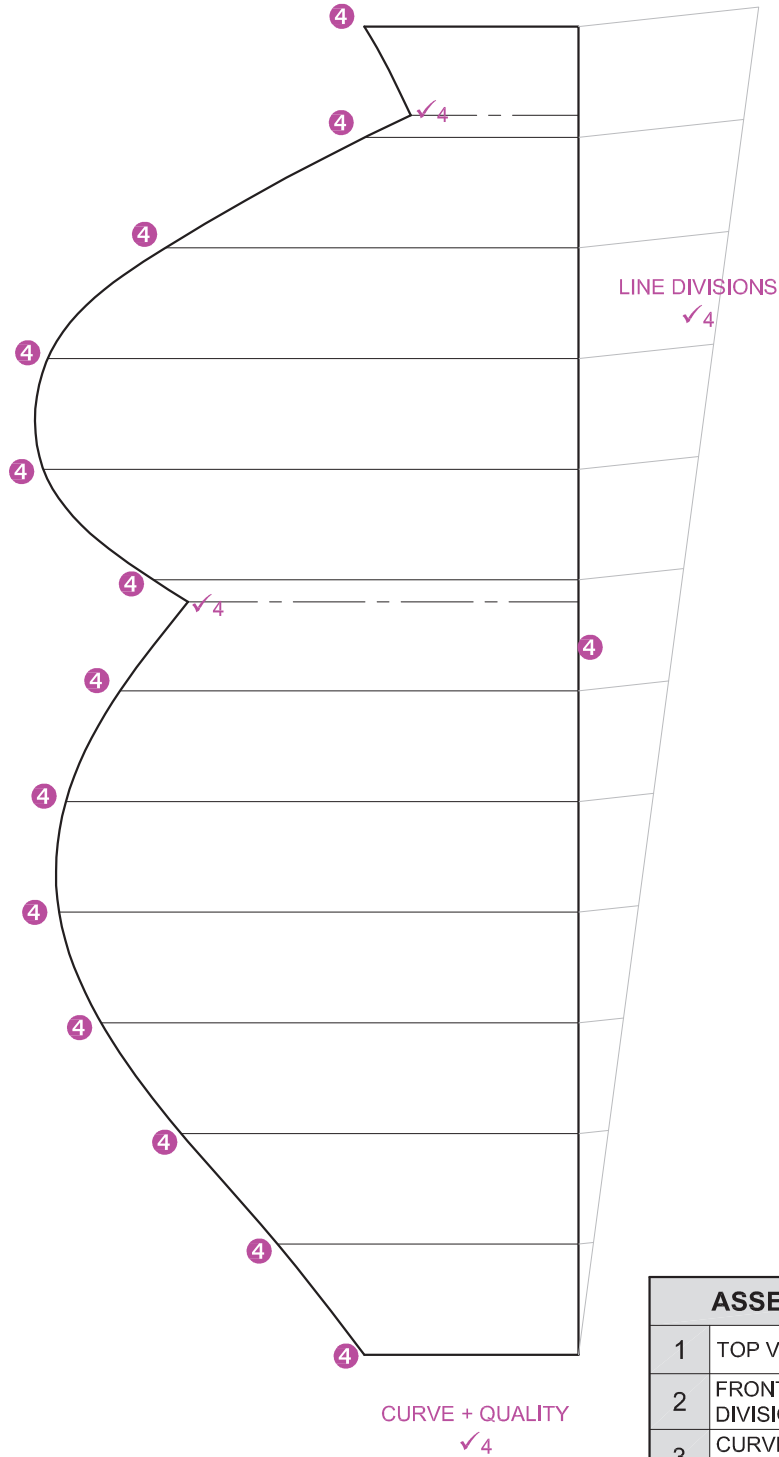

ASSESSMENT CRITERIA		
1	TOP VIEW	10 1/2
2	FRONT VIEW + CIRCLE DIVISION	6 1/2
3	CURVE OF INTERPENETRATION	9
4	DEVELOPMENT	11
TOTAL		37

APPROVED
 PAPER 1 QUESTION 2
 GRADE 12
 SC/NSC 2019
 MARKING GUIDELINES

5. HATCHING MARK ALLOCATION

- PRISM $\frac{1}{2}$
- PYRAMID $\frac{1}{2}$
- DIFFERENT DIRECTIONS $\frac{1}{2}$
- ANY RECOGNIZED METHOD FOR TRUE SHAPE $\frac{1}{2}$

TOTAL 2

4. HATCHING MARK ALLOCATION

- PRISM $\frac{1}{2}$
- PYRAMID $\frac{1}{2}$
- DIFFERENT DIRECTIONS $\frac{1}{2}$

TOTAL 2

1. CONSTRUCTION

- TRIANGLE $\frac{1}{2}$
- HEXAGON + POSITION $\frac{1}{2}$

TOTAL 1

3. HATCHING MARK ALLOCATION

- PRISM $\frac{1}{2}$
- PYRAMID $\frac{1}{2}$
- DIFFERENT DIRECTIONS $\frac{1}{2}$

TOTAL 2

ASSESSMENT CRITERIA		
1	CONSTRUCTION	1
2	FRONT VIEW	5 $\frac{1}{2}$
3	SECTIONAL TOP VIEW	14 $\frac{1}{2}$
4	SECTIONAL LEFT VIEW	12 $\frac{1}{2}$
5	TRUE SHAPE	6 $\frac{1}{2}$
TOTAL		40

PAPER 1 QUESTION 2
 GRADE 12
 NOVEMBER 2018
 MARKING GUIDELINE

PAPER 1 QUESTION 2
 GRADE 12
 SCE 2018
 MARKING GUIDELINES

ASSESSMENT CRITERIA	
1	TOP VIEW
2	FRONT VIEW
3	RIGHT VIEW
TOTAL	
	37

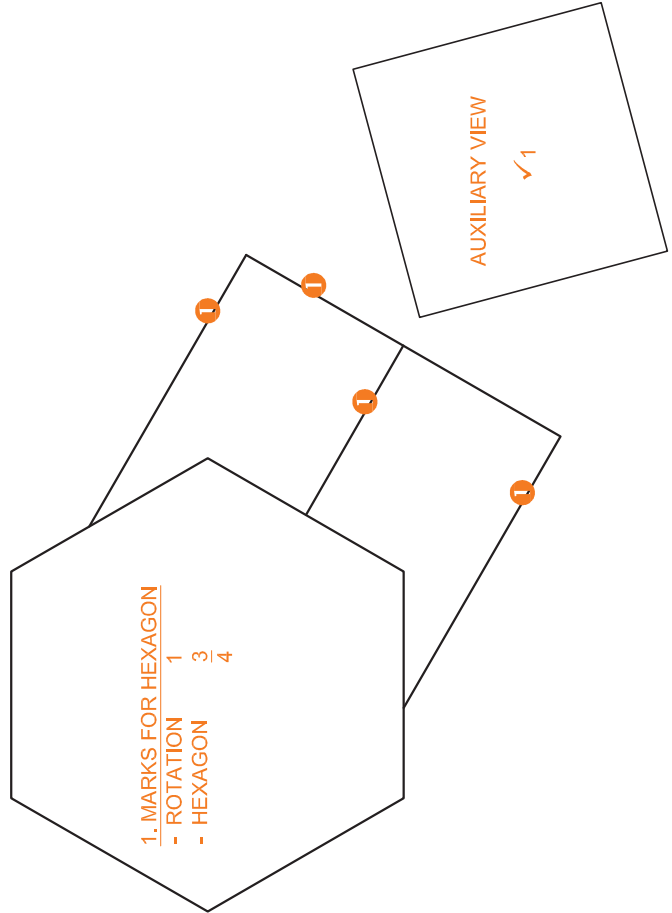
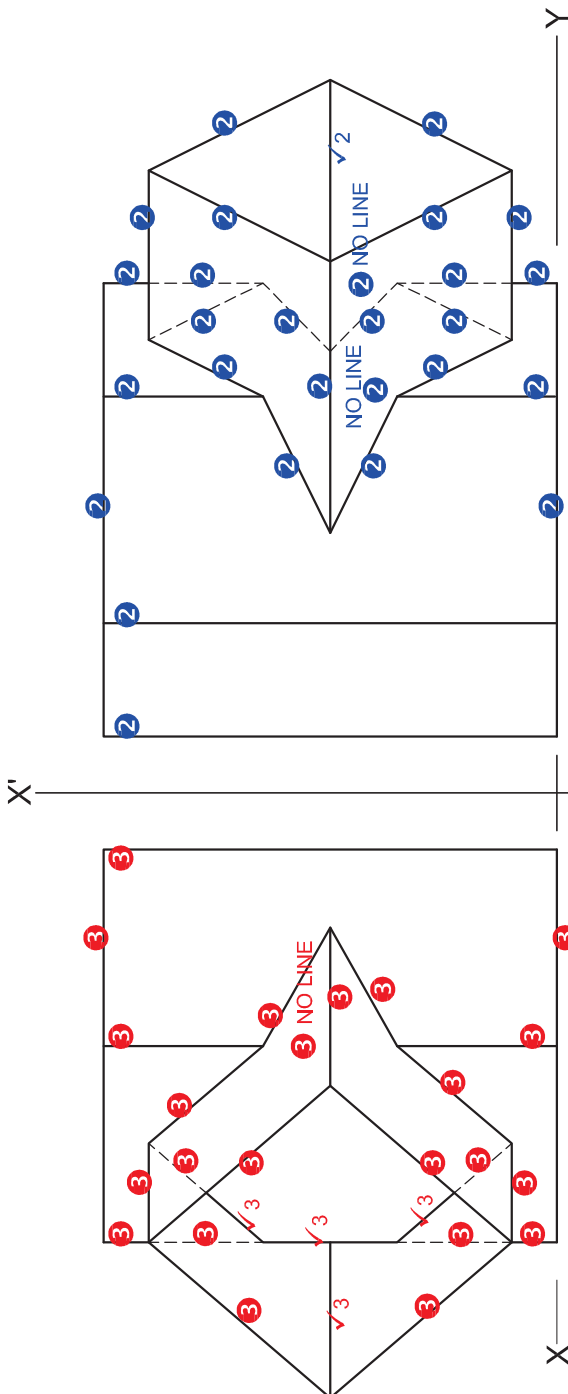

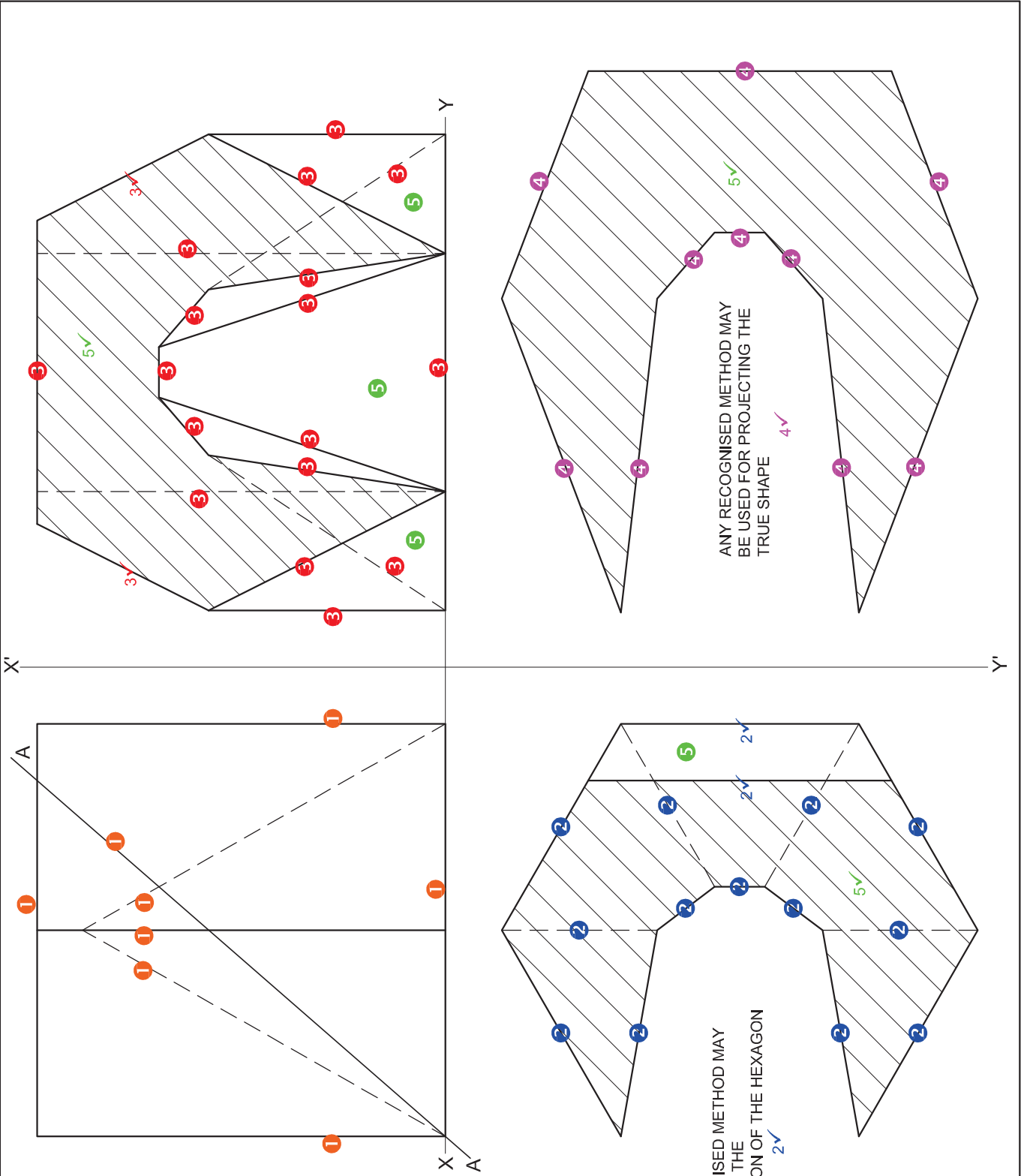

ASSESSMENT CRITERIA	
1	FRONT VIEW
4	
2	SECTIONAL TOP VIEW
9½	
3	SECTIONAL LEFT VIEW
10½	
4	TRUE SHAPE
6	
5	HATCHING
5	
TOTAL	
35	

ANY RECOGNISED METHOD MAY BE USED FOR THE CONSTRUCTION OF THE HEXAGON

ANY RECOGNISED METHOD MAY BE USED FOR PROJECTING THE TRUE SHAPE

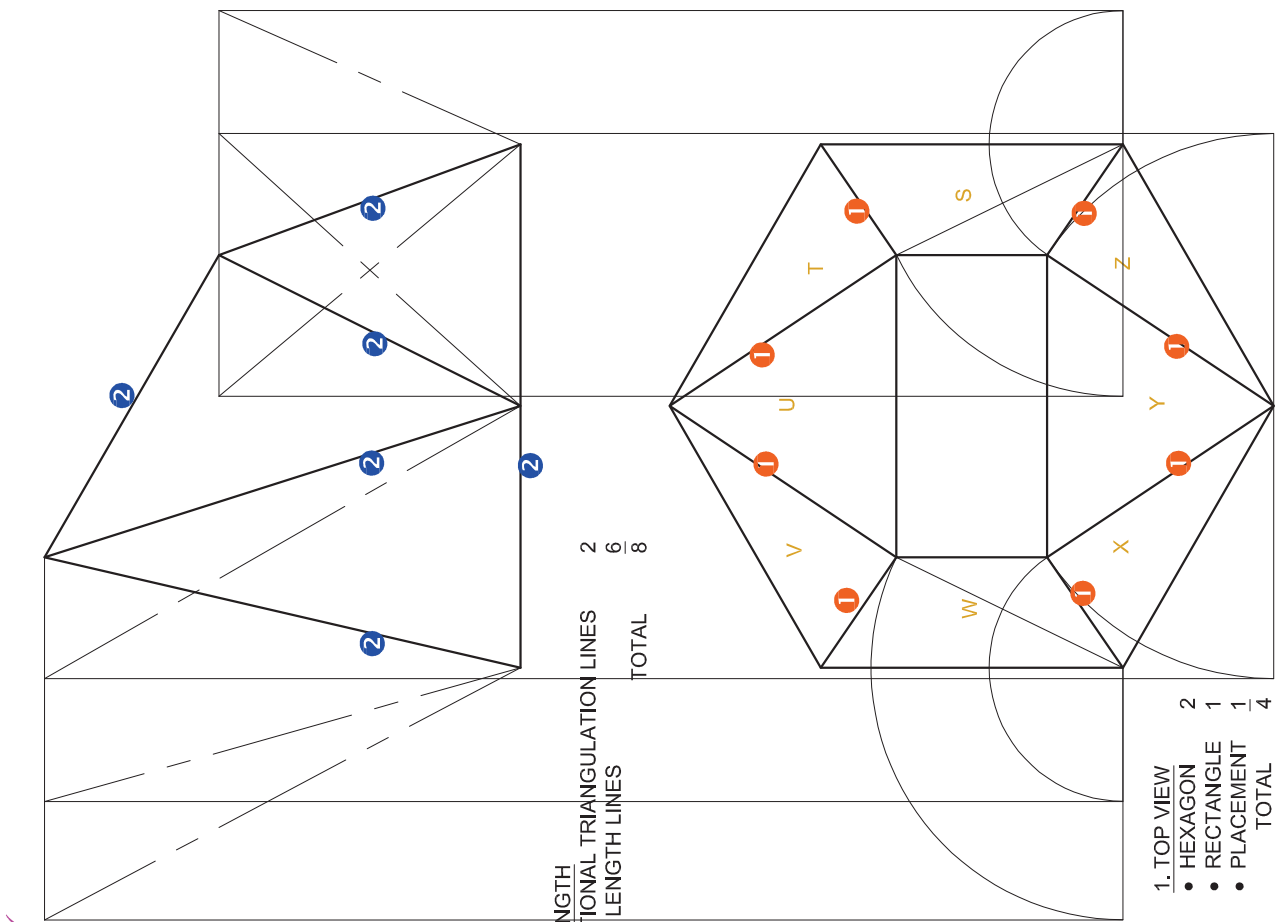

3. TRUE LENGTH
 • 2 x ADDITIONAL TRIANGULATION LINES 2
 • 6 x TRUE LENGTH LINES 6
 TOTAL 8

1. TOP VIEW
 • HEXAGON 2
 • RECTANGLE 1
 • PLACEMENT 1
 TOTAL 4

ASSESSMENT CRITERIA		
1	TOP VIEW	8
2	FRONT VIEW	3
3	TRUE LENGTH	8
4	DEVELOPMENT	19
TOTAL		38

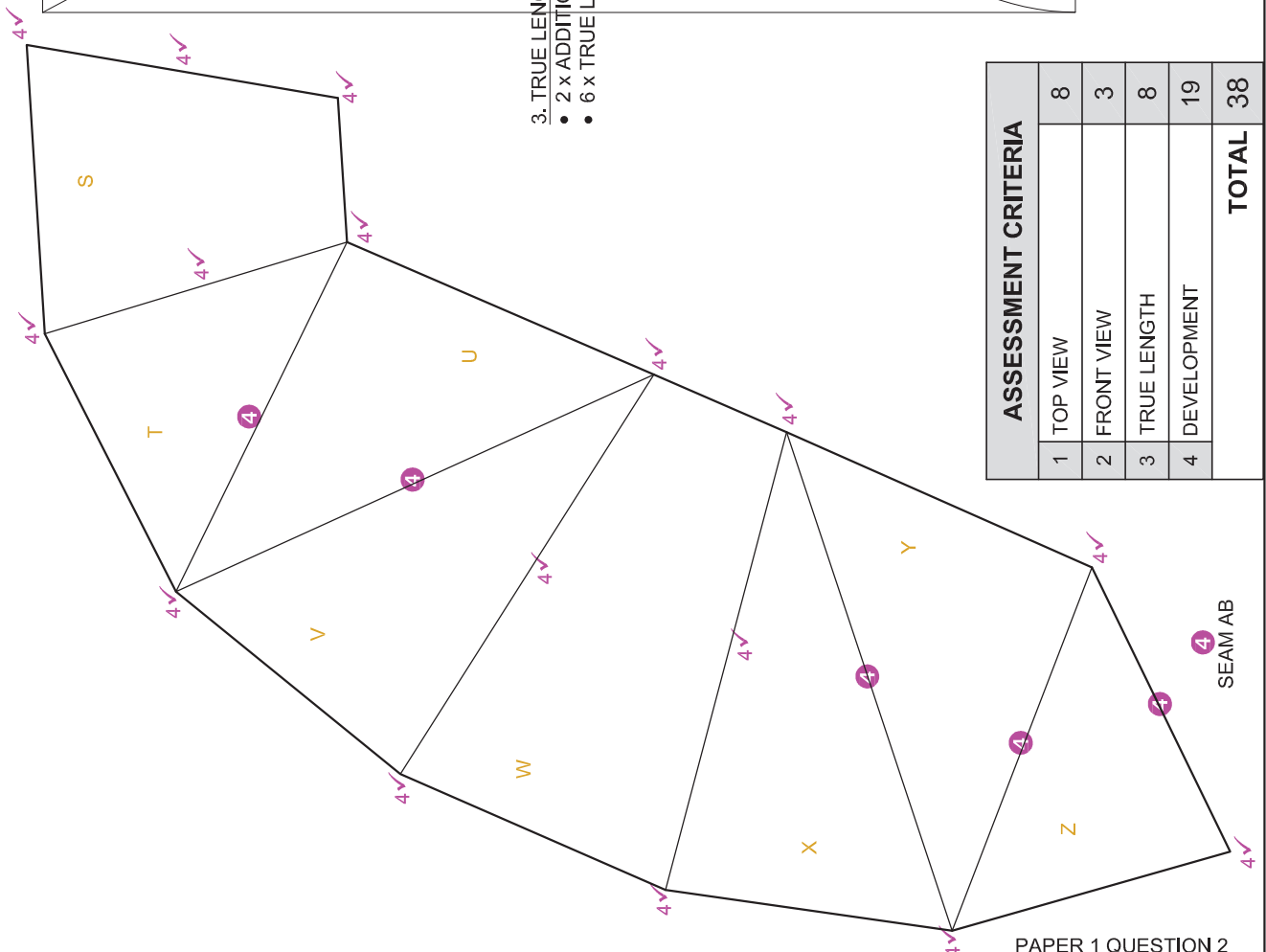

PAPER 1 QUESTION 2
 GRADE 12
 SSE 2017
 MARKING GUIDELINES

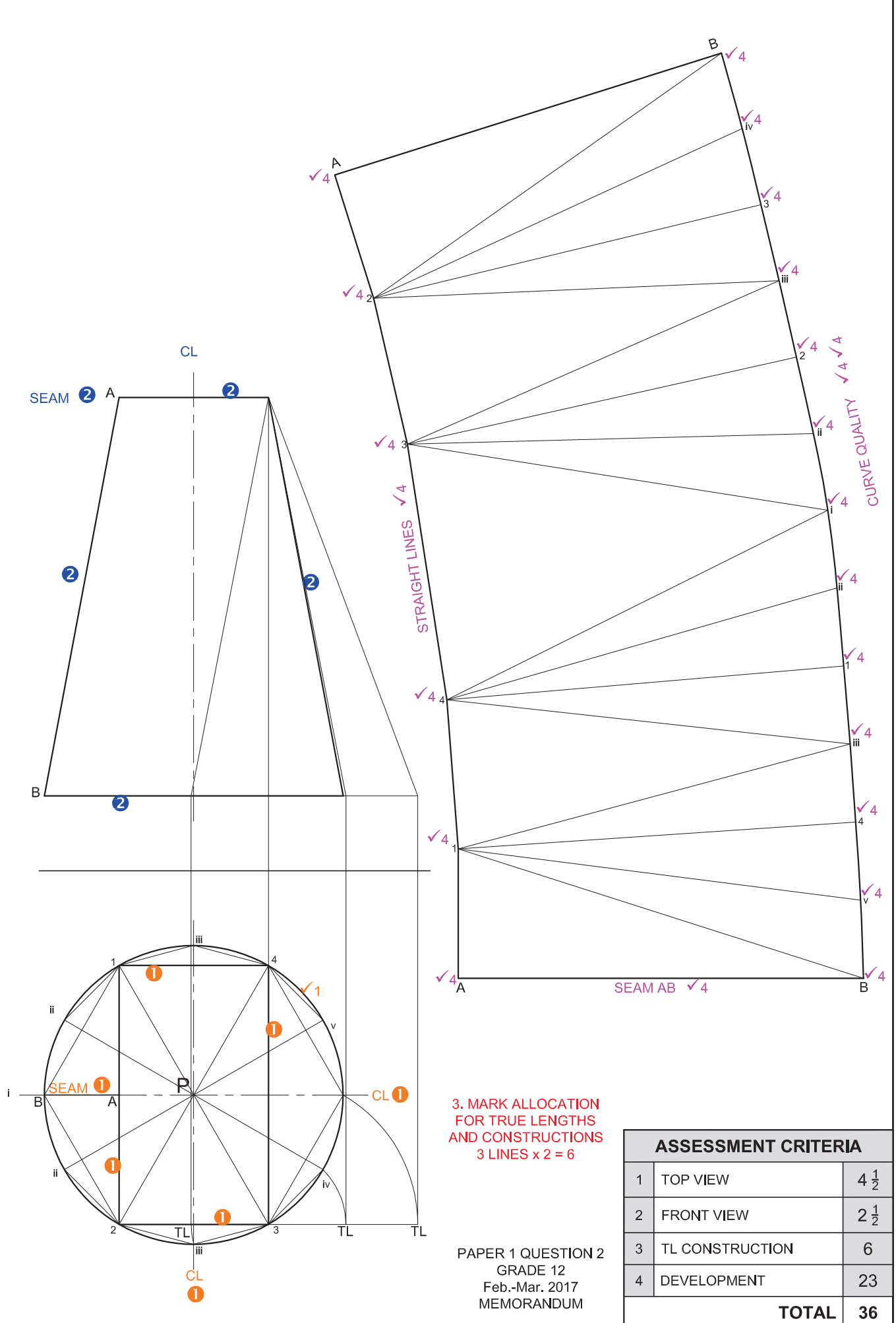

3. MARK ALLOCATION FOR TRUE LENGTHS AND CONSTRUCTIONS
3 LINES x 2 = 6

PAPER 1 QUESTION 2
GRADE 12
Feb.-Mar. 2017
MEMORANDUM

ASSESSMENT CRITERIA		
1	TOP VIEW	4 1/2
2	FRONT VIEW	2 1/2
3	TL CONSTRUCTION	6
4	DEVELOPMENT	23
TOTAL		36

1. POLYGON CONSTRUCTION

- TRIANGLE 1
- HEXAGON 1
- HEXAGON ROTATION 1
- TOTAL 3**

PAPER 1 QUESTION 2
 GRADE 12
 NOVEMBER 2016
 MEMORANDUM

ASSESSMENT CRITERIA	
1	CONSTRUCTION 3
2	FRONT VIEW 9
3	SECTIONAL TOP VIEW 11
4	SECTIONAL RIGHT VIEW 14
PENALTIES (-)	
TOTAL 37	

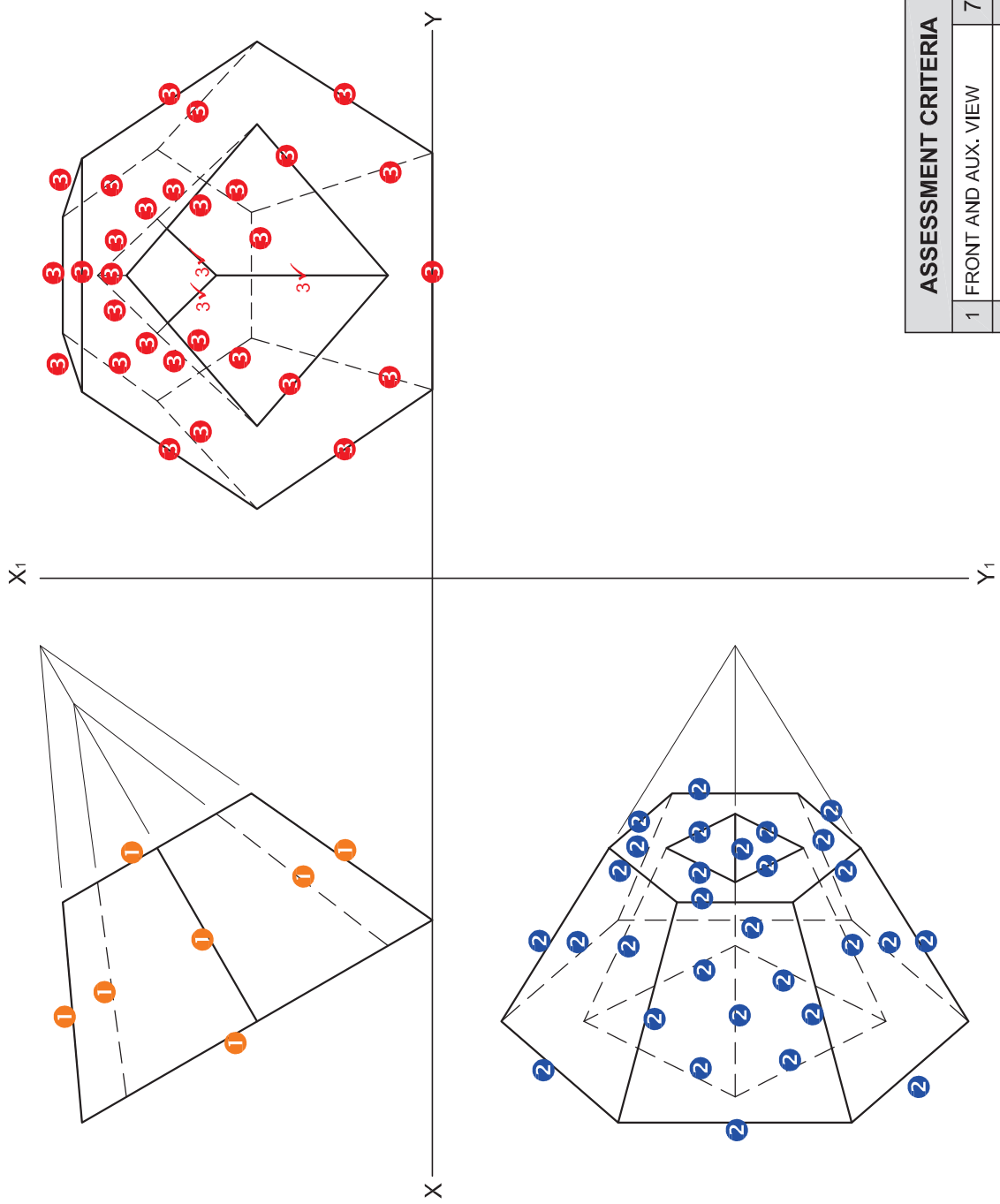

ASSESSMENT CRITERIA		
1	FRONT AND AUX. VIEW	7½
2	TOP VIEW	15
3	LEFT VIEW	17½
TOTAL		40

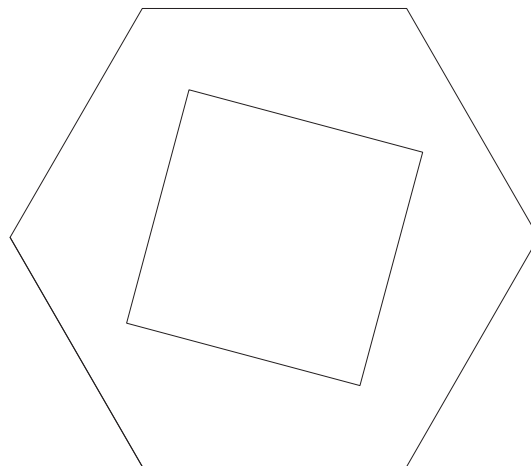

ANY ACCEPTABLE
CONSTRUCTION METHOD
USED FOR THE
AUXILIARY VIEW
1✓✓✓

PAPER 1 QUESTION 2
GRADE 12
Feb.-Mar.2016
MEMORANDUM

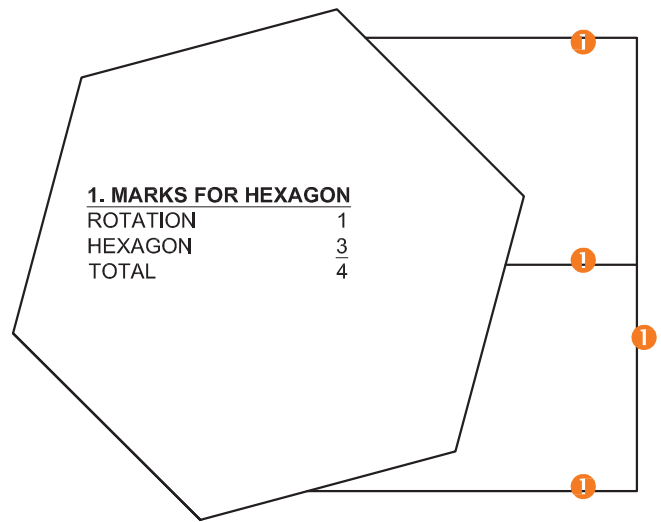
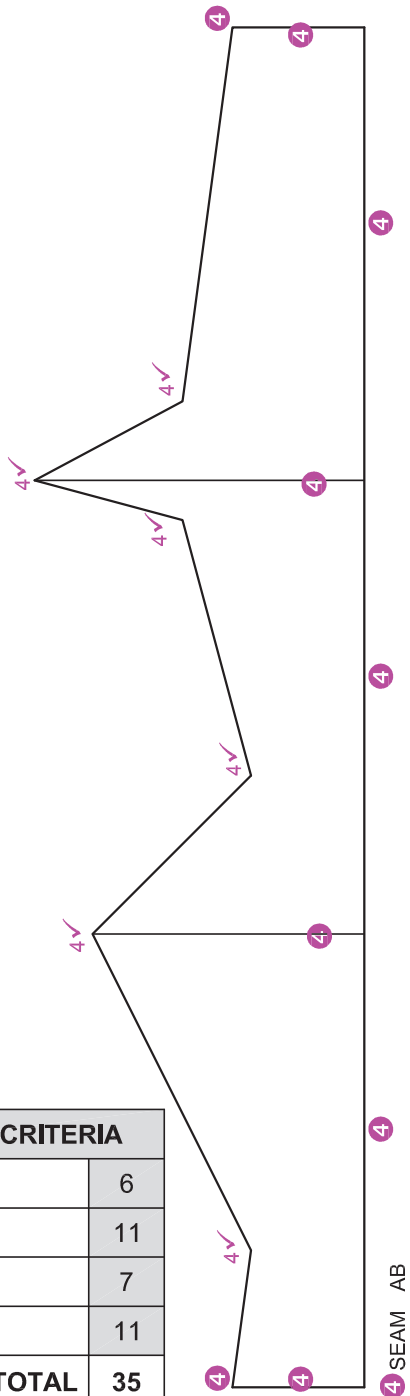
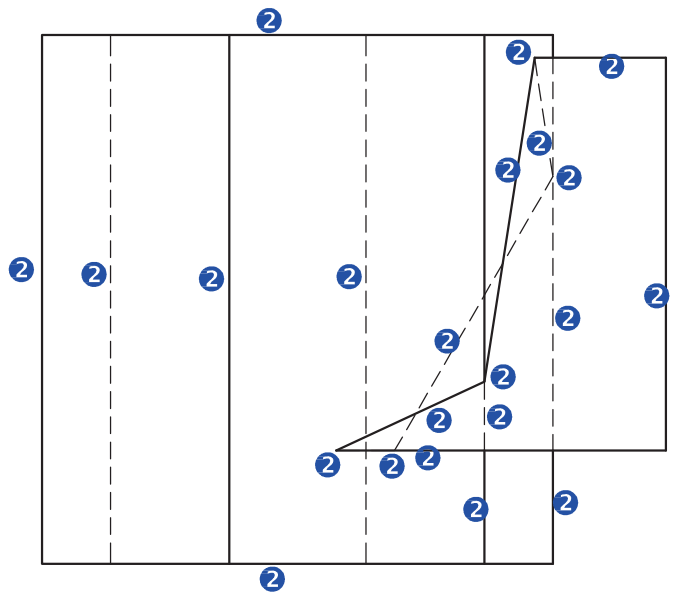
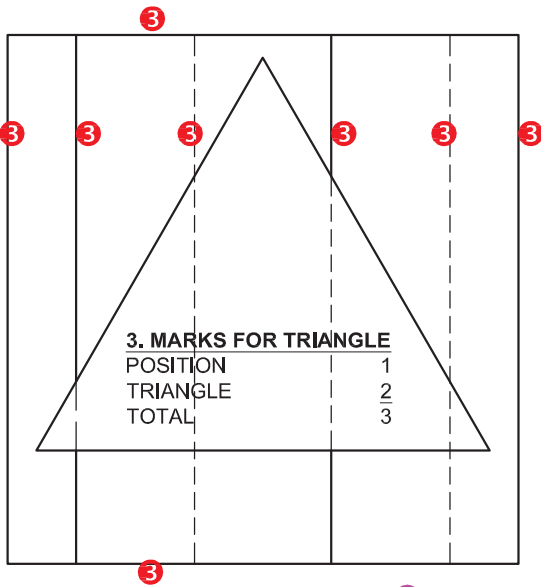

ASSESSMENT CRITERIA		
1	TOP VIEW	6
2	FRONT VIEW	11
3	RIGHT VIEW	7
4	DEVELOPMENT	11
TOTAL		35

4 SEAM AB

PAPER 1 QUESTION 2
 GRADE 12
 November 2015
 MEMORANDUM

(2) MARK ALLOCATION
FOR TRUE LENGTH
CONSTRUCTION:
4 LINES x 2 = 8

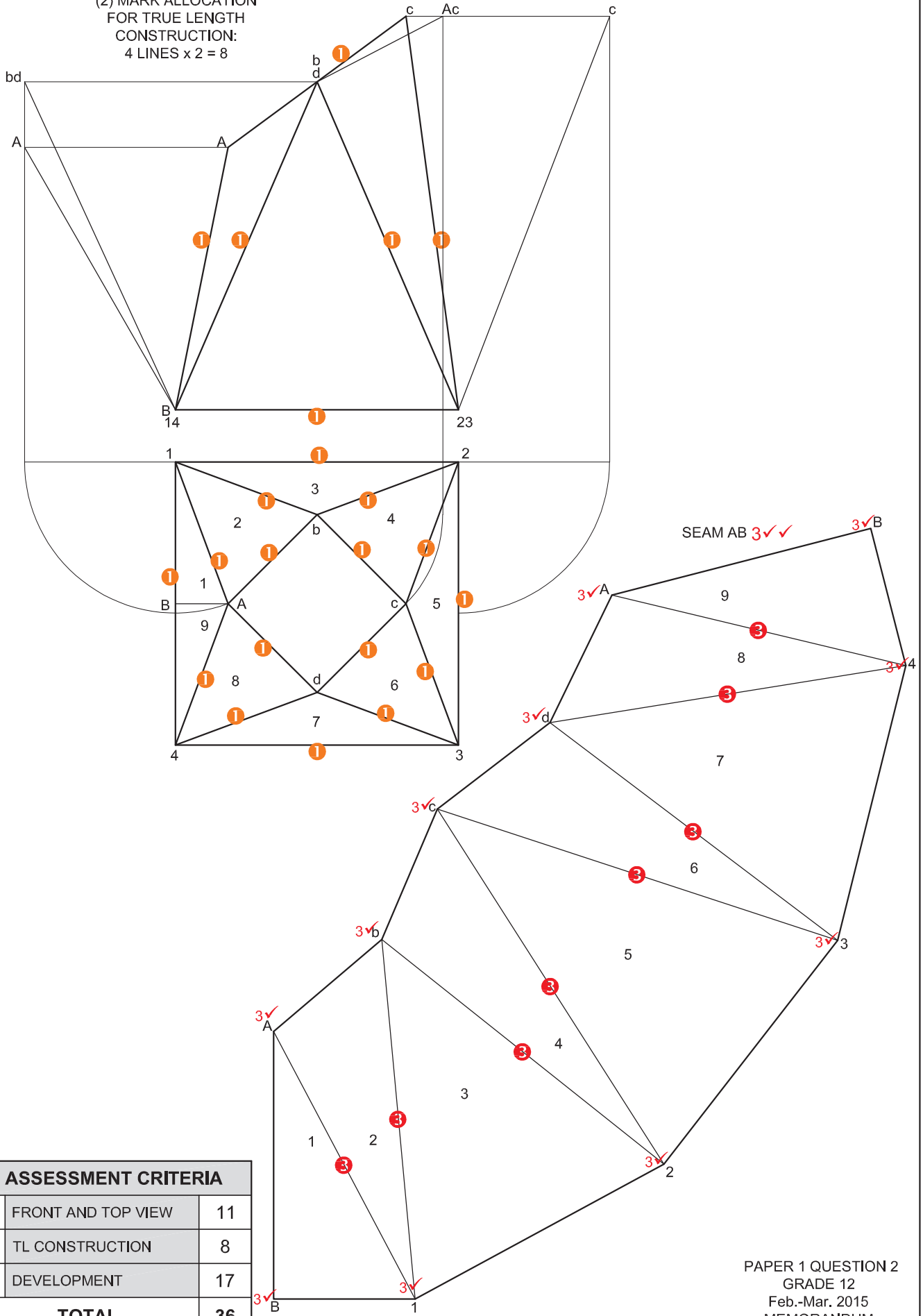

ASSESSMENT CRITERIA		
1	FRONT AND TOP VIEW	11
2	TL CONSTRUCTION	8
3	DEVELOPMENT	17
TOTAL		36

PAPER 1 QUESTION 2
GRADE 12
Feb.-Mar. 2015
MEMORANDUM

The drawing illustrates the construction of a composite object in three views: Front View (top), Top View (middle), and Left View (bottom). The object consists of a pentagonal pyramid on top of a hexagonal prism with a square hole. Construction lines and hatching are used to define the object's geometry. Markings include 'H4' for hidden lines, '3' for construction points, and '2' for construction points. Checkmarks indicate completed construction steps.

Front View (Top): Shows the profile of the object. The pentagonal pyramid is on the left, the hexagonal prism is in the middle, and the square hole is on the right. Construction lines and hatching are used to define the object's geometry. Markings include 'H4' for hidden lines and '3' for construction points.

Top View (Middle): Shows the object from above. The pentagonal pyramid is on the left, the hexagonal prism is in the middle, and the square hole is on the right. Construction lines and hatching are used to define the object's geometry. Markings include 'H4' for hidden lines and '2' for construction points.

Left View (Bottom): Shows the object from the left. The pentagonal pyramid is on the left, the hexagonal prism is in the middle, and the square hole is on the right. Construction lines and hatching are used to define the object's geometry. Markings include 'H4' for hidden lines and '2' for construction points.

Construction Labels:

- HEXAGONAL PRISM ✓1
- SQUARE HOLE ✓1
- PENTAGONAL PYRAMID ✓✓1
- HEXAGON ✓✓2
- SQUARE ✓✓2
- PENTAGON CONSTRUCTION ✓1
- POSITION ✓1

ASSESSMENT CRITERIA	
1	CONST. + FRONT VIEW 7
2	SECTIONAL TOP VIEW 12½
3	SECTIONAL LEFT VIEW 15
4	HATCHING 3½
TOTAL 38	

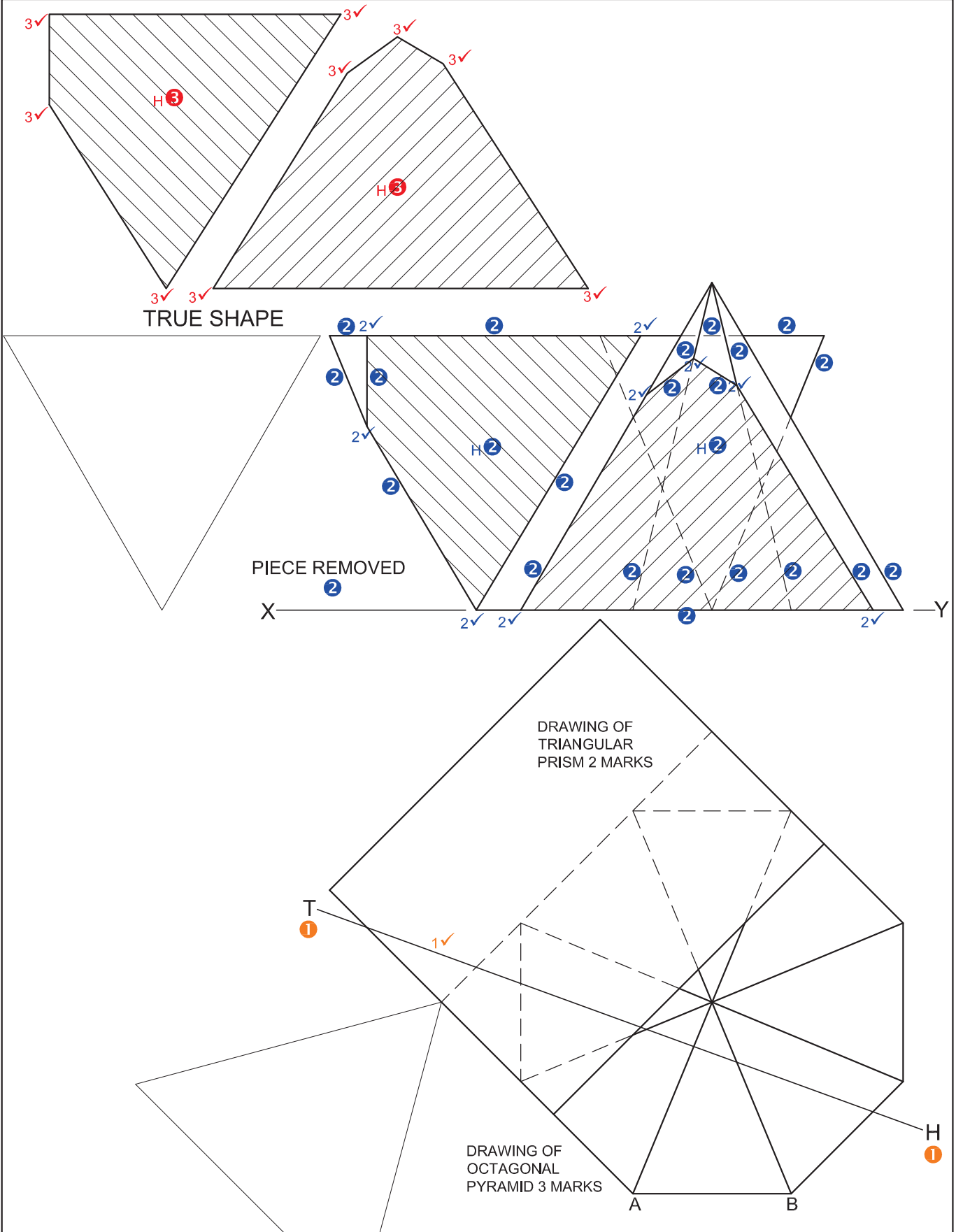

ASSESSMENT CRITERIA		
1	GIVEN TOP VIEW	7
2	FRONT VIEW	21
3	TRUE SHAPE	10
TOTAL		38

PAPER 1 QUESTION 2
 GRADE 12
 EXEMPLAR 2014
 MEMORANDUM

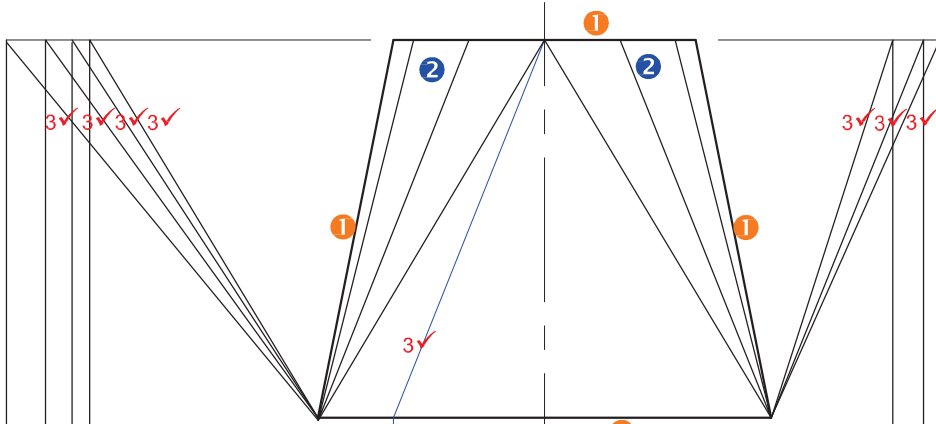

NOTE:
ANY RECOGNISED METHODS
OF DETERMINING THE TRUE
LENGTHS ARE ACCEPTABLE.

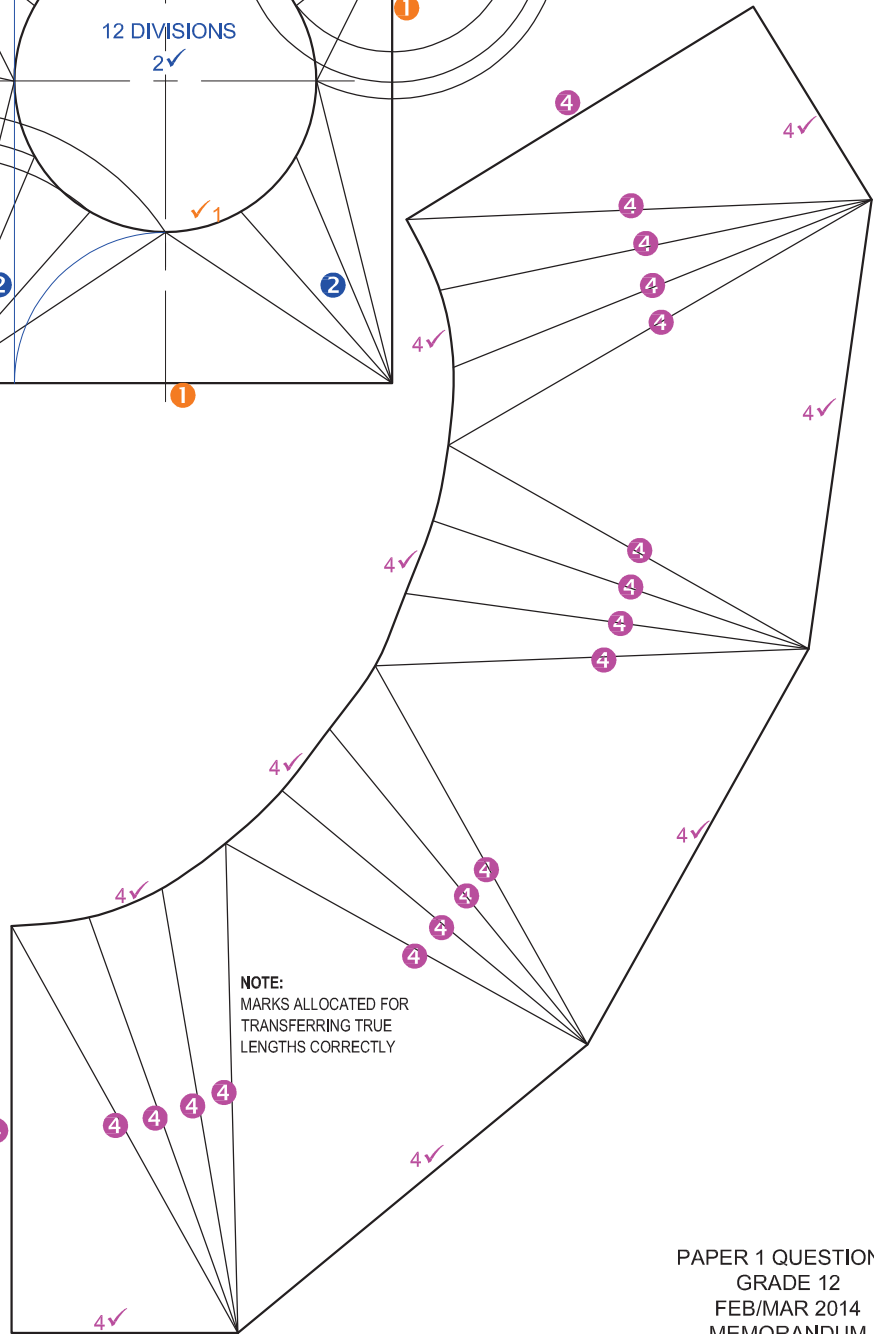
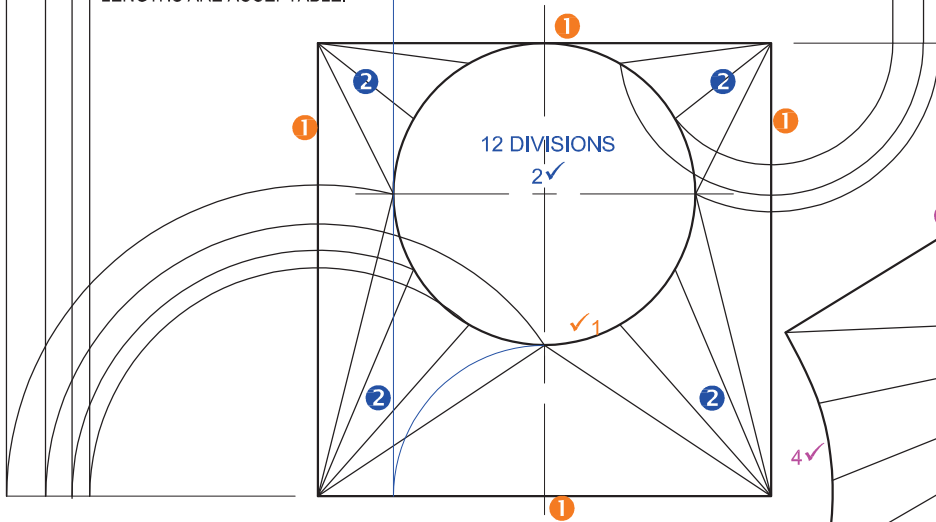

ASSESSMENT CRITERIA

1	GIVEN	5
2	CONSTRUCTION	4
3	TRUE LENGTHS	8
4	DEVELOPMENT	18
TOTAL		35

NOTE:
MARKS ALLOCATED FOR
TRANSFERRING TRUE
LENGTHS CORRECTLY

PAPER 1 QUESTION 2
GRADE 12
FEB/MAR 2014
MEMORANDUM

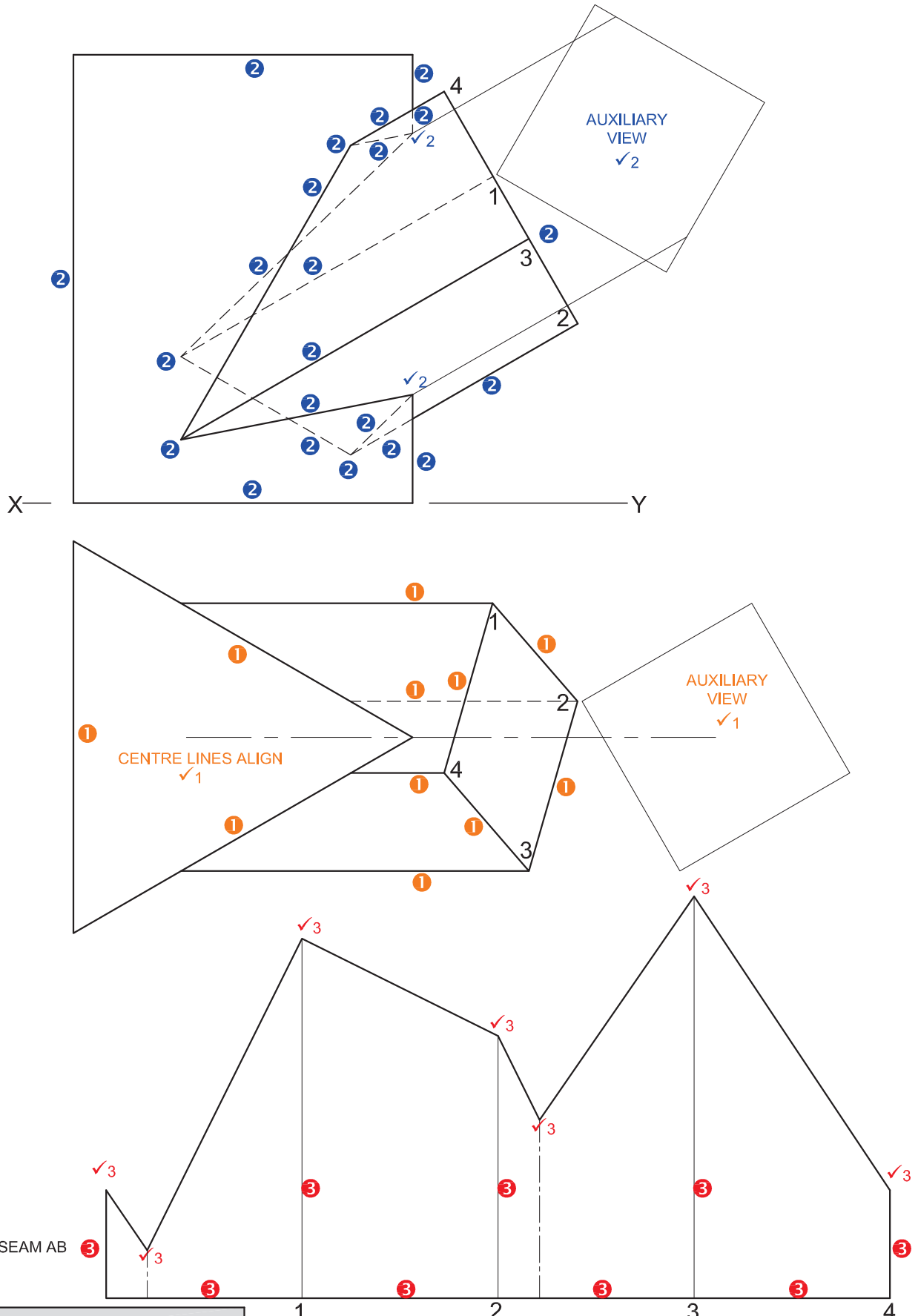

ASSESSMENT CRITERIA		
1	TOP VIEW	7½
2	FRONT VIEW	14
3	DEVELOPMENT	11½
TOTAL		33

PAPER 1 QUESTION 2
 GRADE 12
 November 2013
 MEMORANDUM

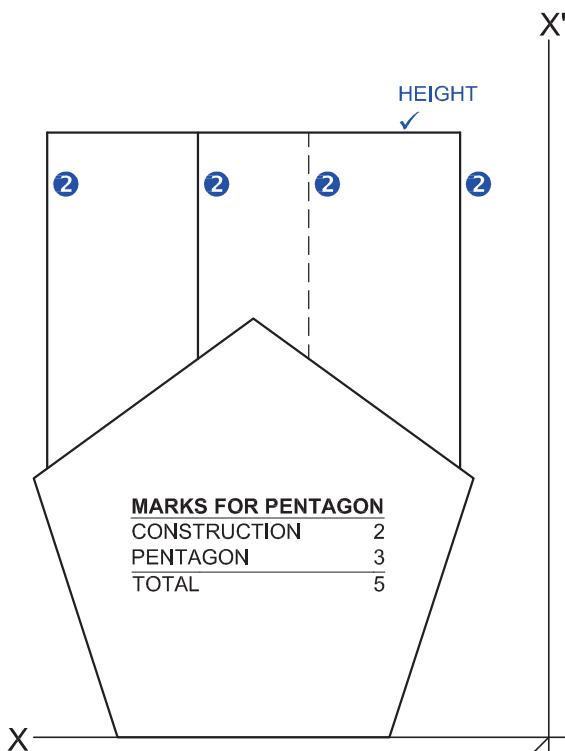
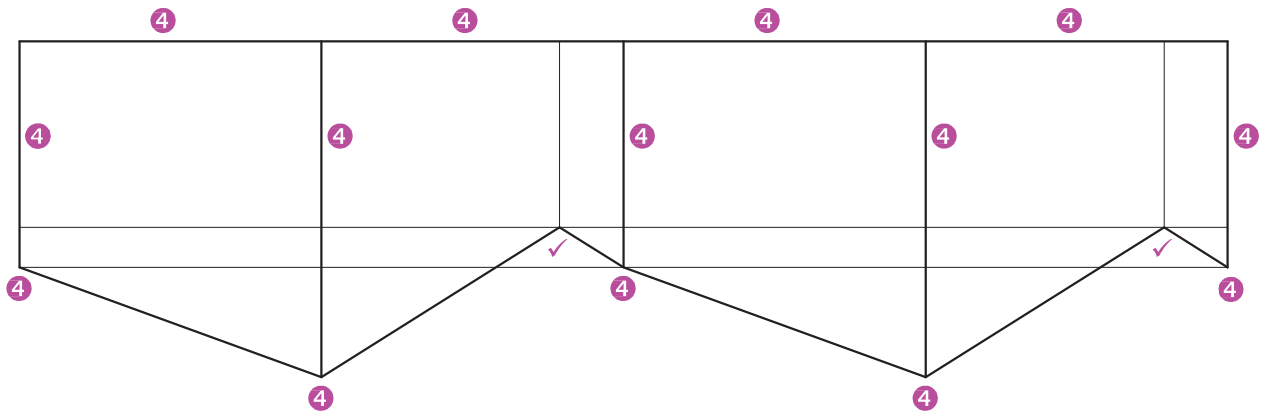

MARKS FOR PENTAGON	
CONSTRUCTION	2
PENTAGON	3
TOTAL	5

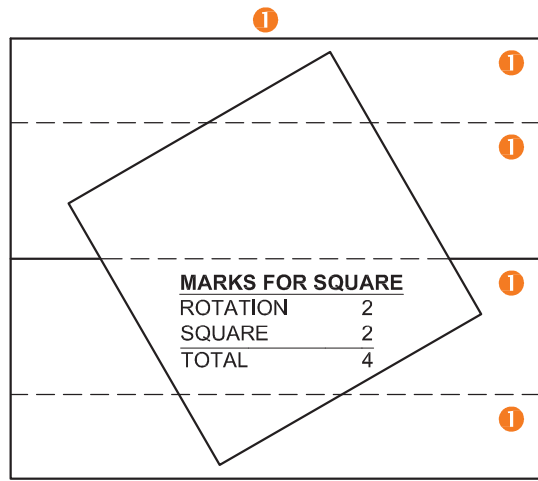
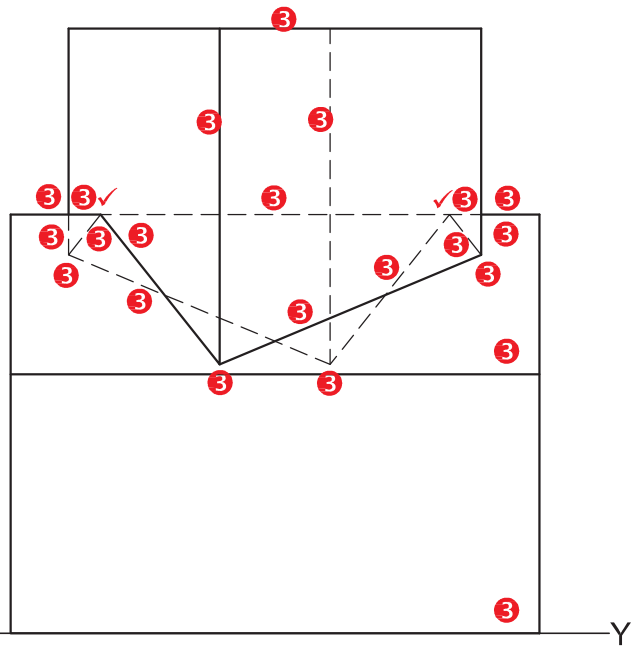

MARKS FOR SQUARE	
ROTATION	2
SQUARE	2
TOTAL	4

ASSESSMENT CRITERIA		
1	TOP VIEW	7
2	RIGHT VIEW	8
3	FRONT VIEW	13
4	DEVELOPMENT	9
TOTAL		37

PAPER 1 QUESTION 2
 GRADE 12
 FEB/MAR 2013
 MEMORANDUM

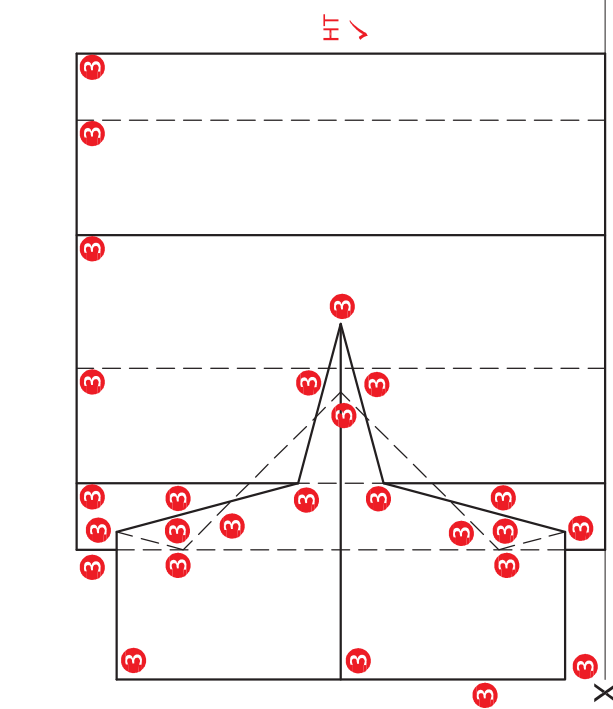
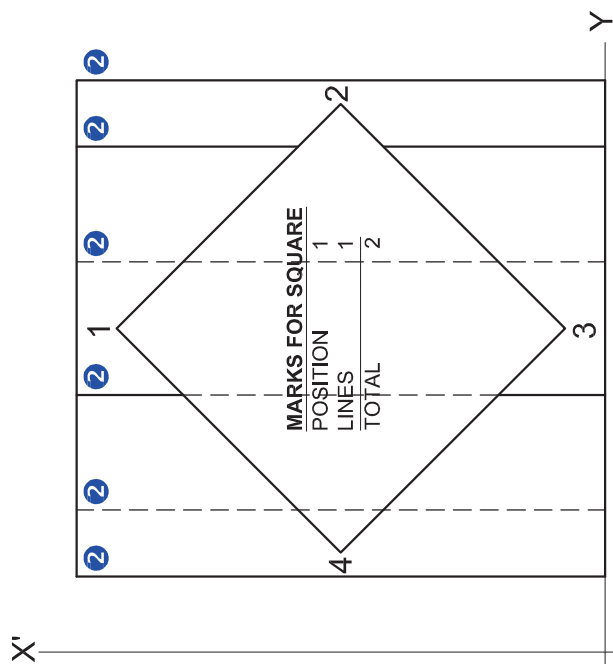
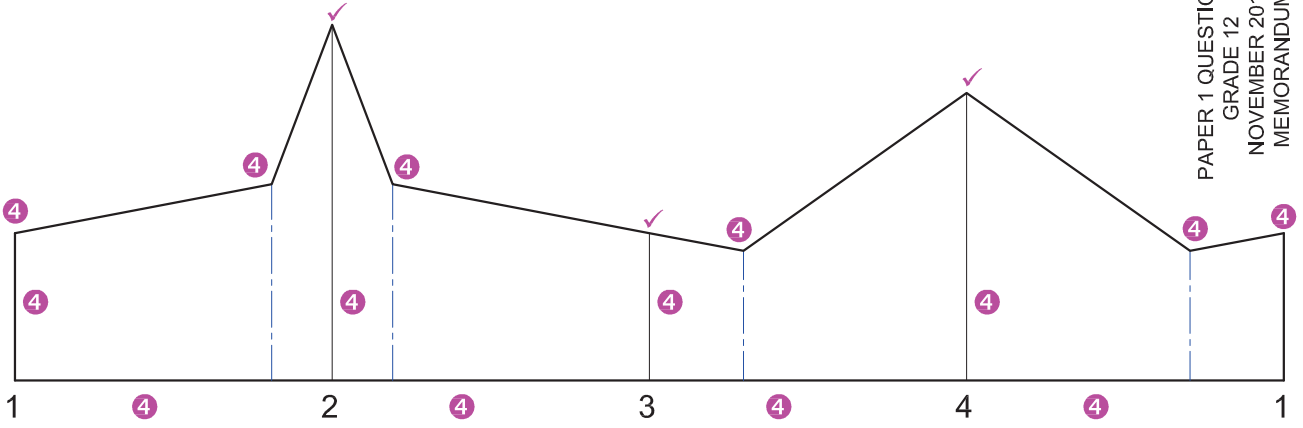

ASSESSMENT CRITERIA		
1	TOP VIEW	6
2	LEFT VIEW	5
3	FRONT VIEW	14
4	DEVELOPMENT	10
TOTAL		35

NOTE:
 ALL RECOGNISED METHODS OF
 DETERMINING THE TRUE LENGTH
 ARE ACCEPTABLE.

TRUE LENGTH ASSESSMENT
 5 x LINES = 5
 5 x METHOD = 5
 10

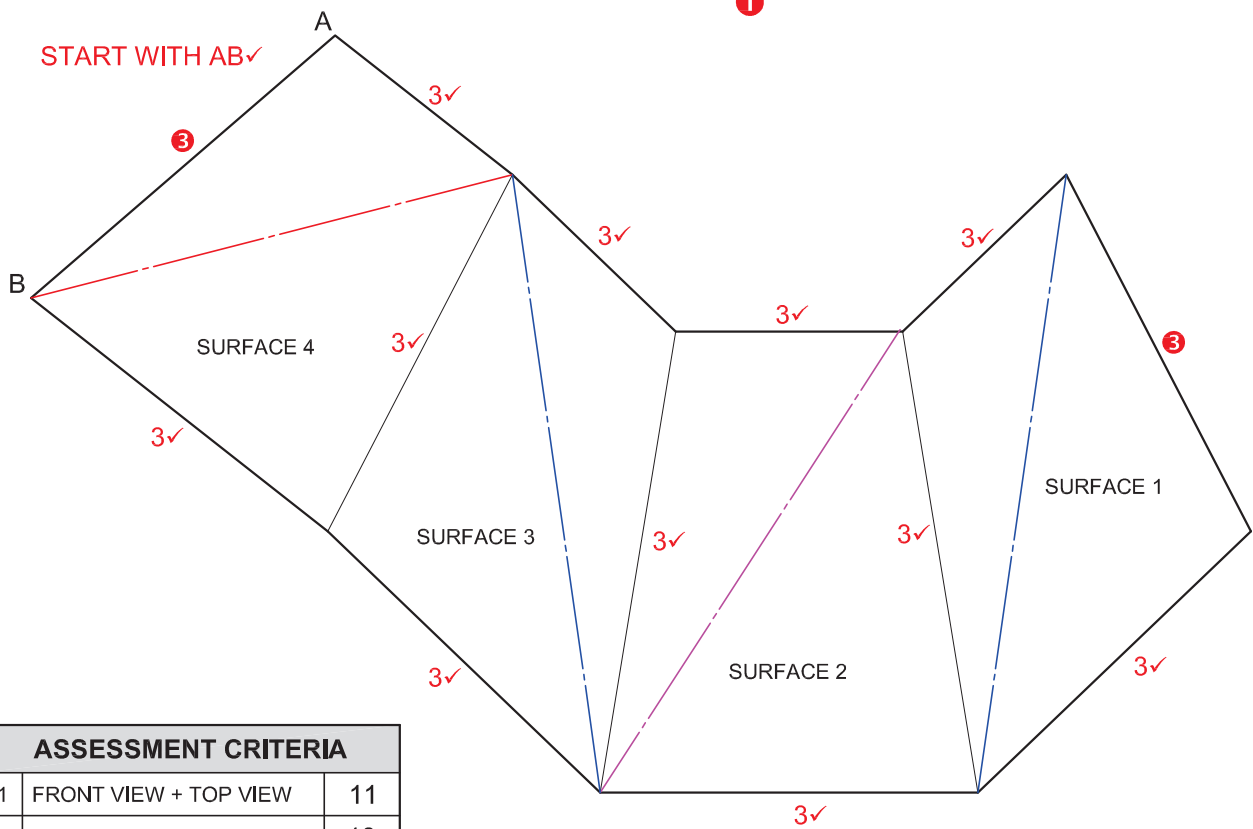
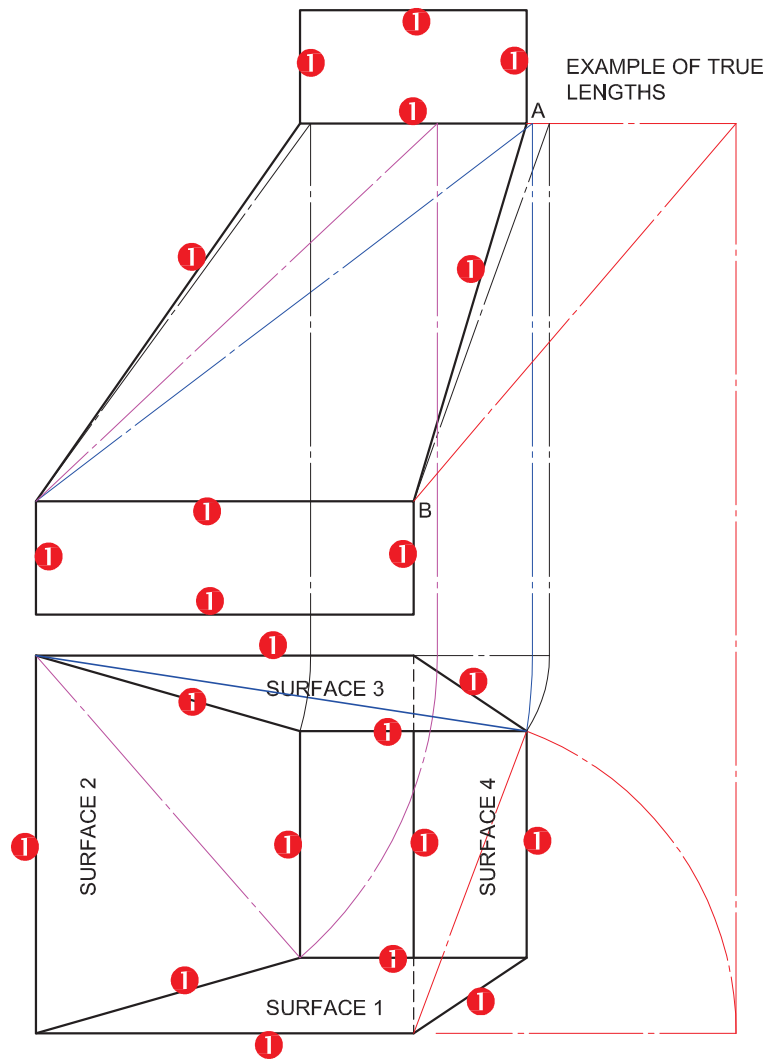

ASSESSMENT CRITERIA		
1	FRONT VIEW + TOP VIEW	11
2	TRUE LENGTH METHOD	10
3	DEVELOPMENT	13
TOTAL		34

PAPER 1 QUESTION 2
 GRADE 12
 Feb.-Mar. 2012
 MEMORANDUM

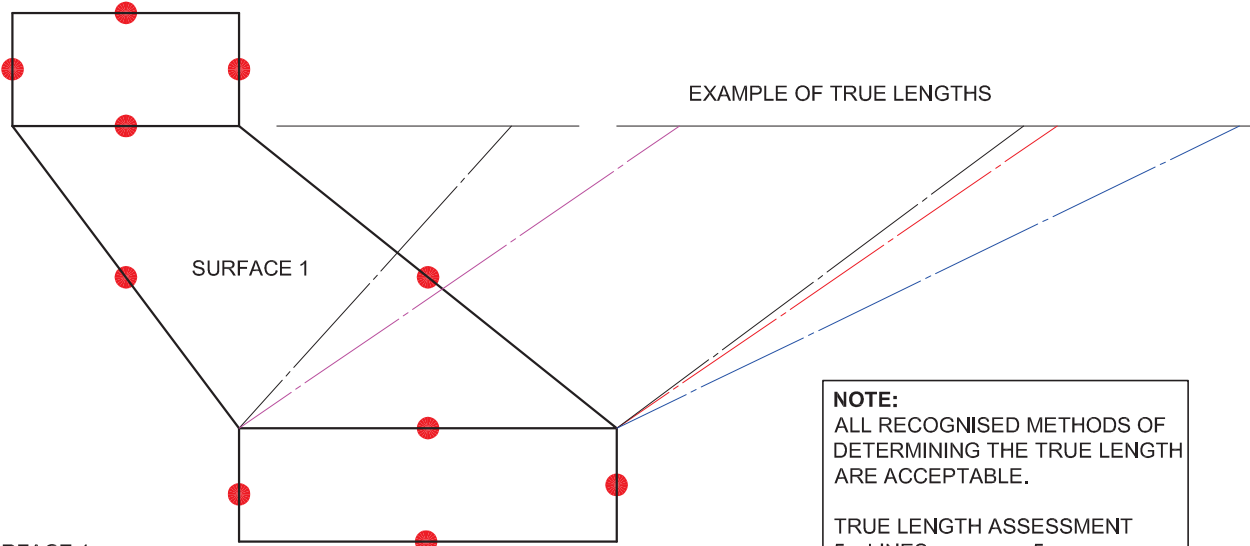

NOTE:
 ALL RECOGNISED METHODS OF
 DETERMINING THE TRUE LENGTH
 ARE ACCEPTABLE.

TRUE LENGTH ASSESSMENT
 5 x LINES = 5
 5 x METHOD = 5
 10

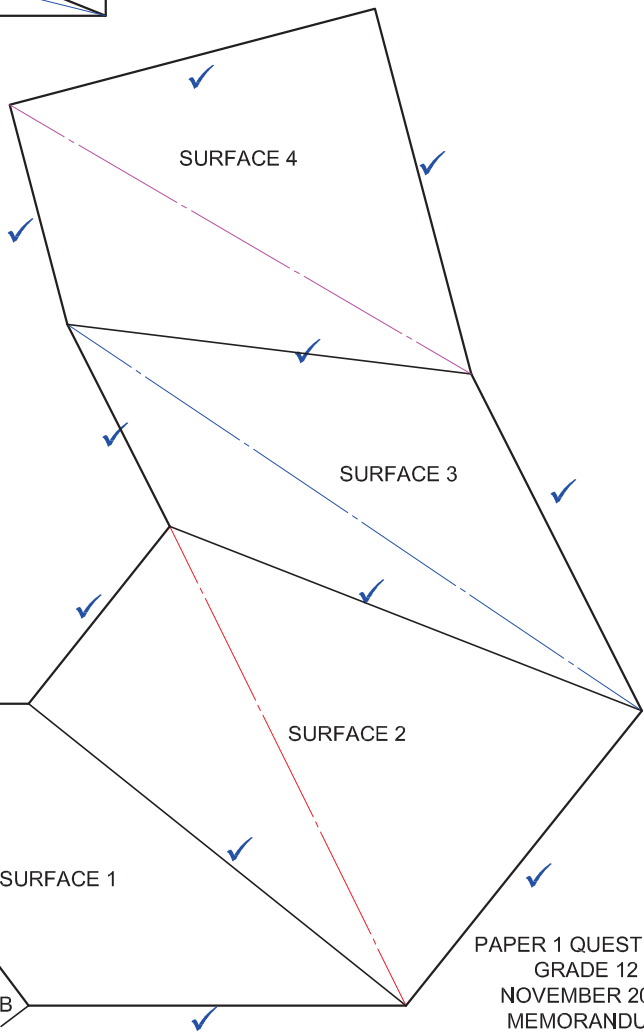
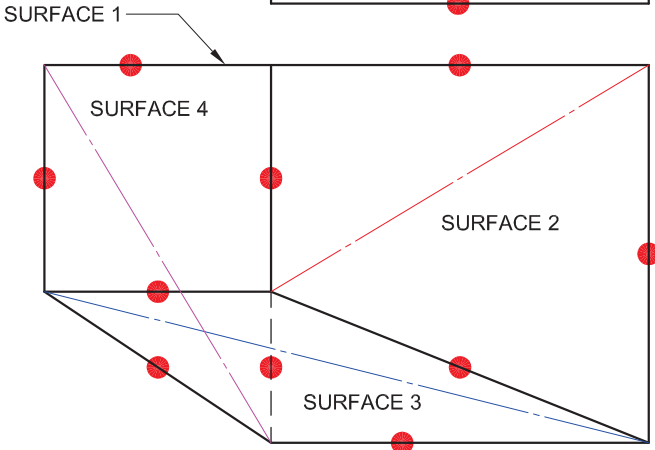

START WITH AB ✓

ASSESSMENT CRITERIA	
FRONT VIEW + TOP VIEW	10
TRUE LENGTH + METHOD	10
DEVELOPMENT	14
TOTAL	34

PAPER 1 QUESTION 2
 GRADE 12
 NOVEMBER 2011
 MEMORANDUM

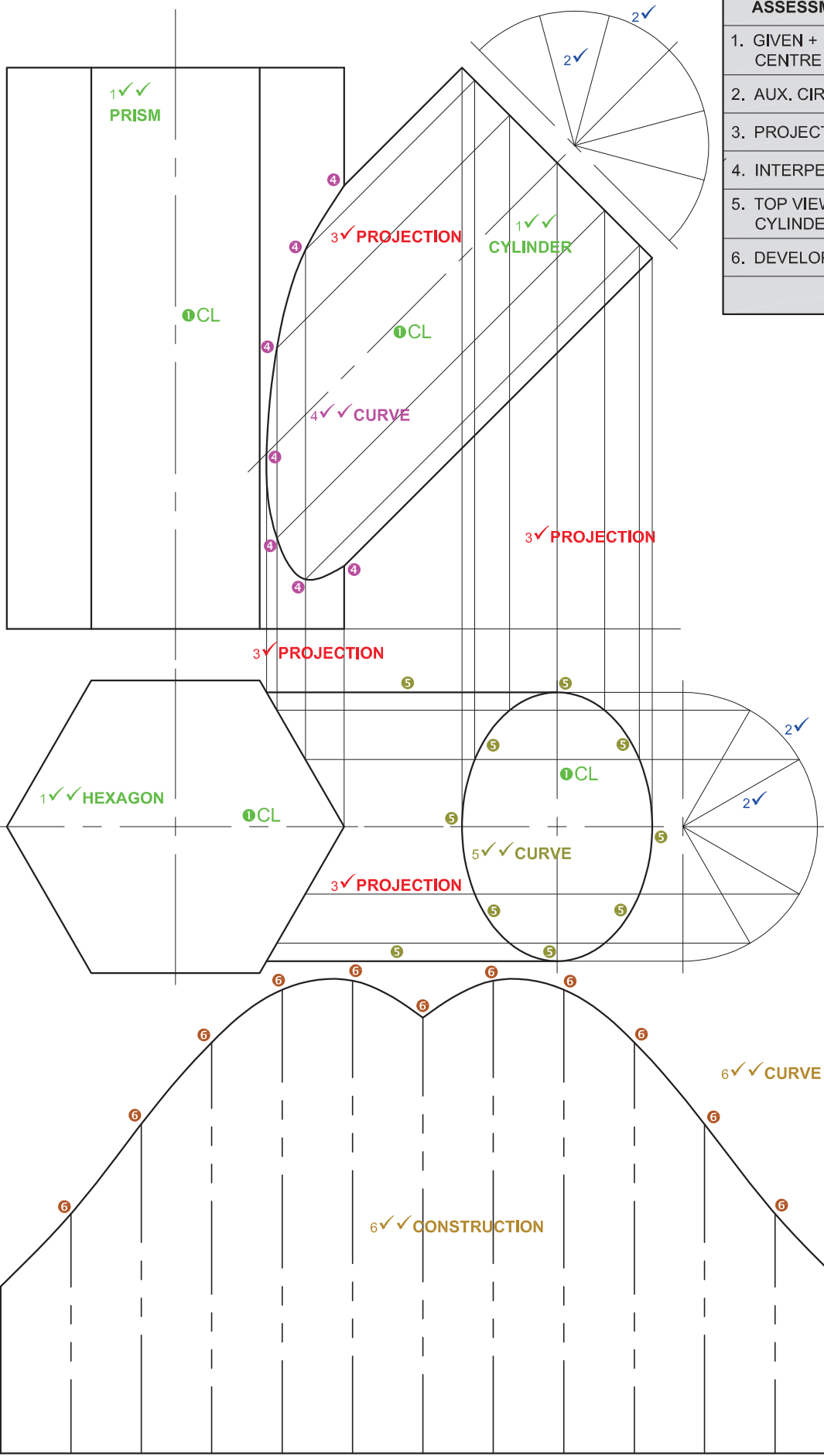

ASSESSMENT CRITERIA	
1. GIVEN + CENTRE LINES	8
2. AUX. CIRCLES	4
3. PROJECTION	4
4. INTERPENETRATION	5½
5. TOP VIEW OF CYLINDER	7
6. DEVELOPMENT	11½
TOTAL	40

PAPER 1 QUESTION 2
 GRADE 12
 FEBRUARY/MARCH 2011
 MEMORANDUM

ASSESSMENT CRITERIA	
1. GIVEN	8
2. TRUE LENGTHS	4
3. DEVELOPMENT A	14
4. DEVELOPMENT B	4
5. DEVELOPMENT C	7
TOTAL	37

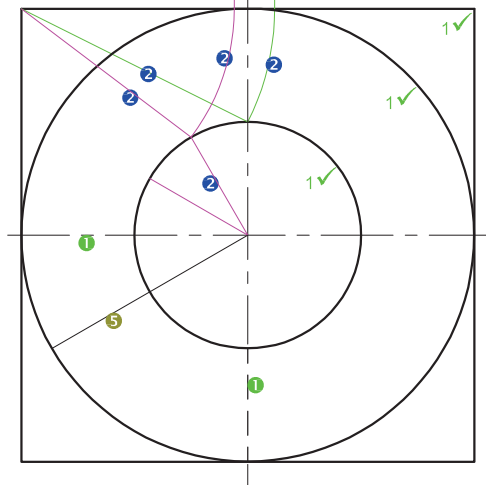
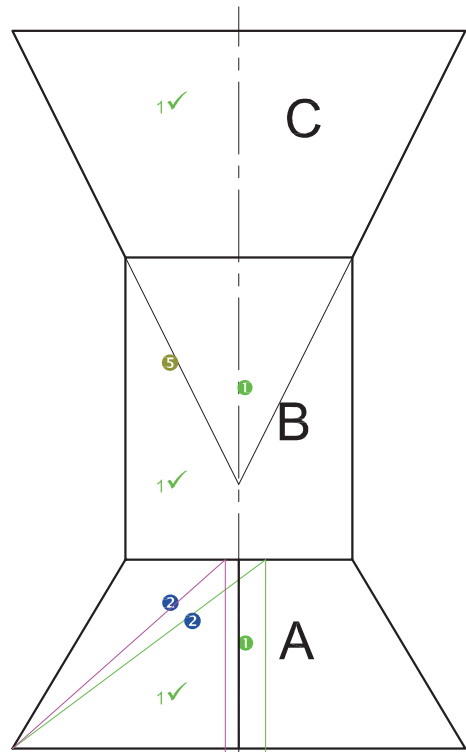
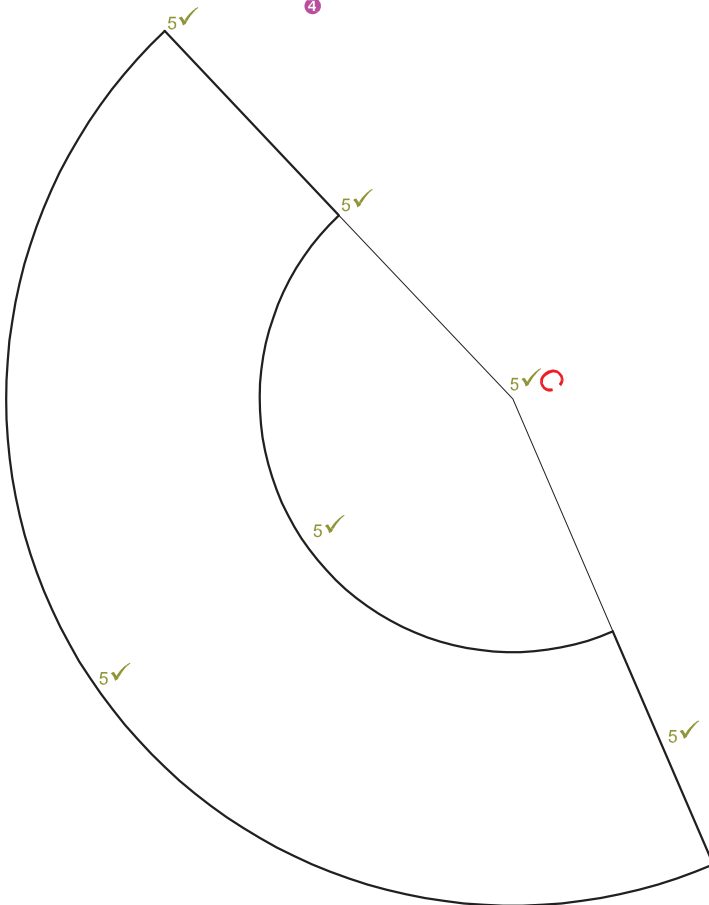
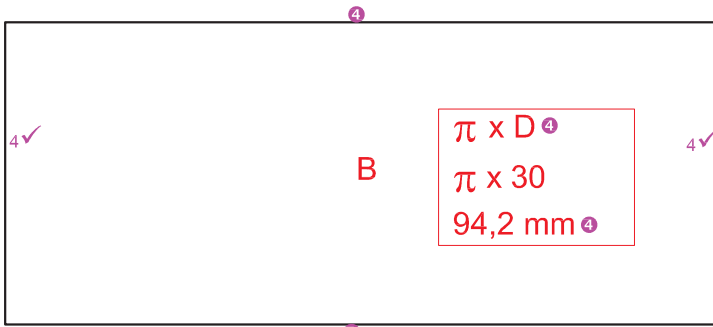
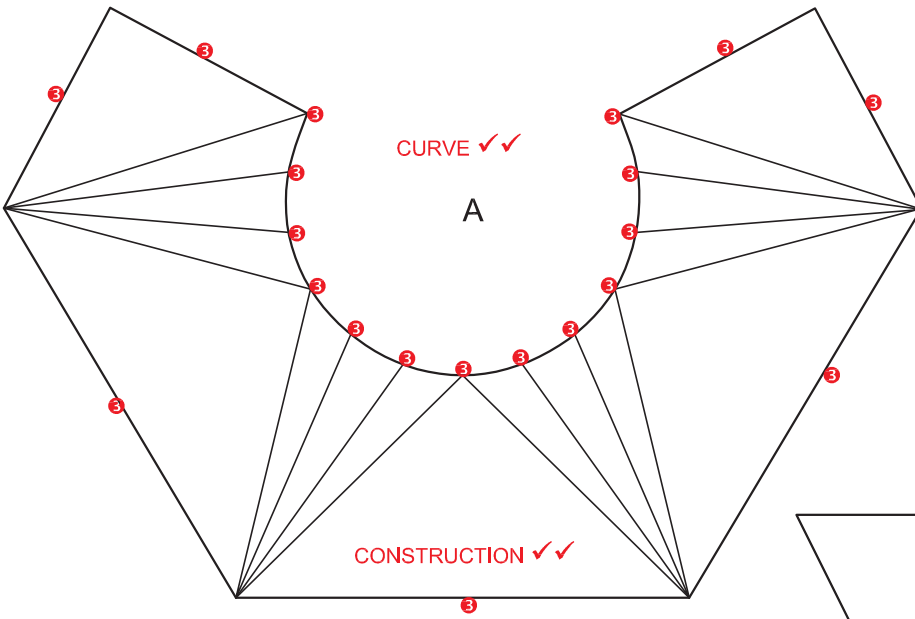

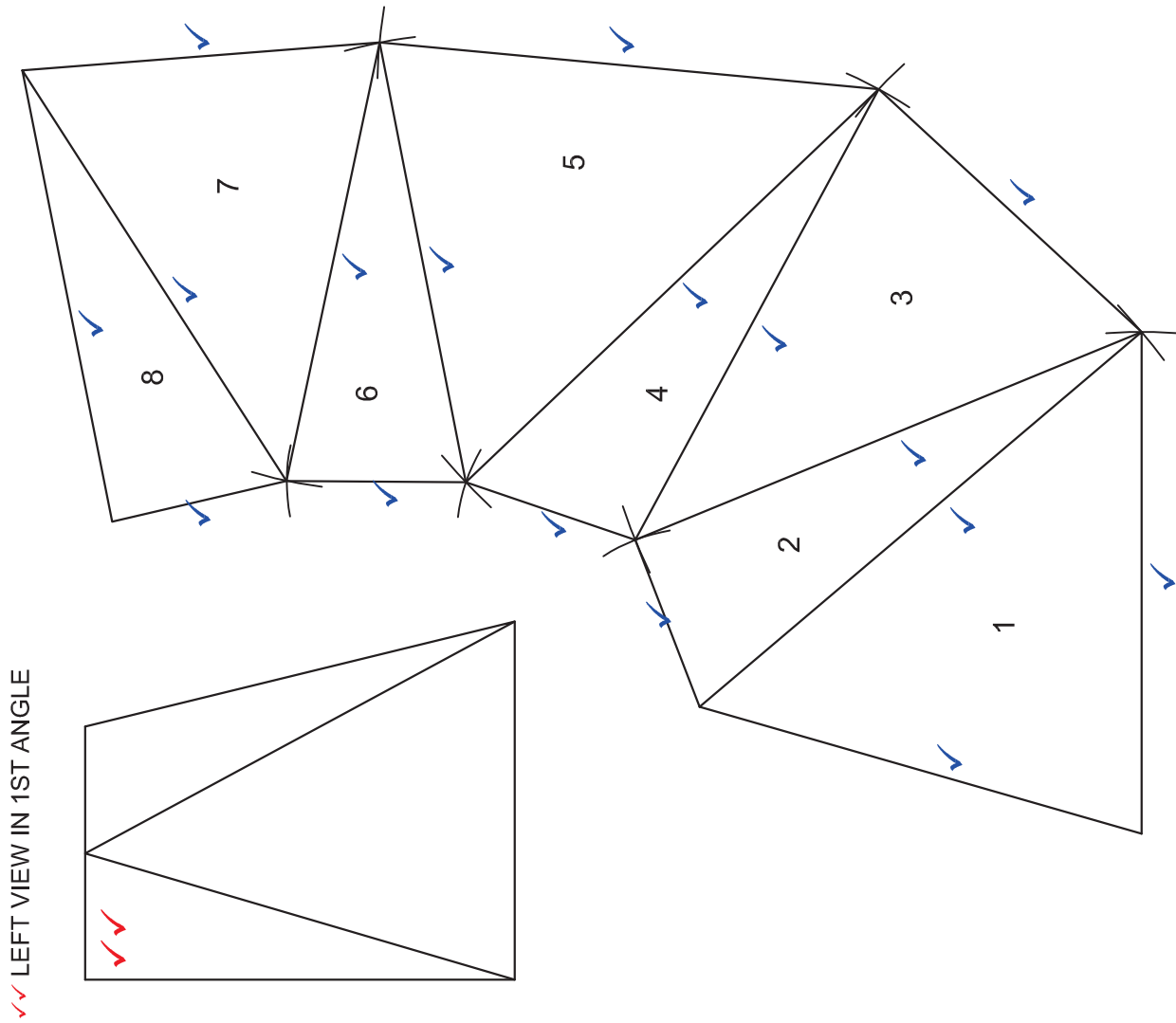

✓✓ LEFT VIEW IN 1ST ANGLE

ANY RECOGNISED METHOD OF DETERMINING THE TRUE LENGTH OF THE LINES WILL BE ACCEPTABLE.

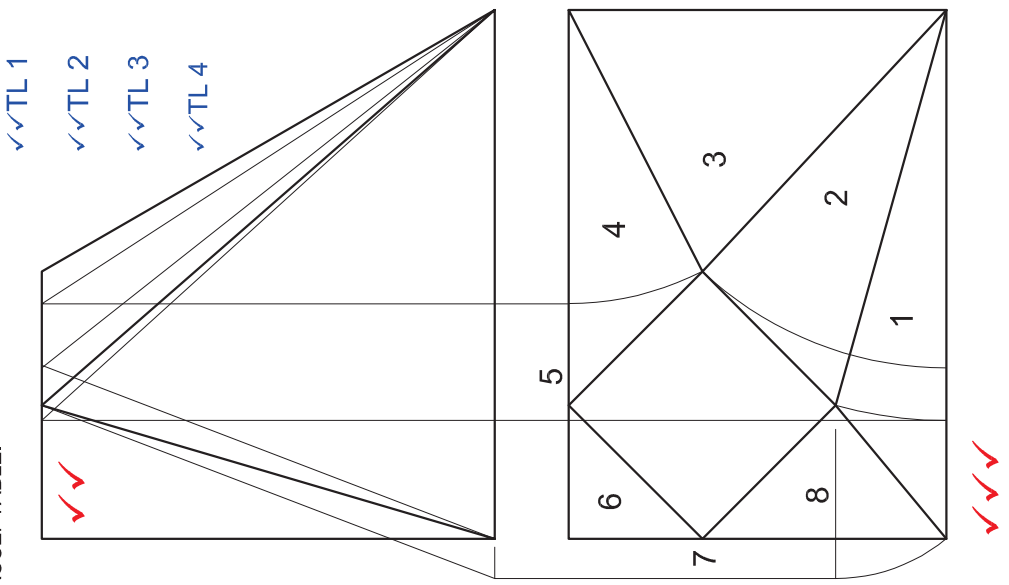

✓✓TL1
✓✓TL2
✓✓TL3
✓✓TL4

ASSESSMENT CRITERIA	
TOP + FRONT + LEFT VIEW	9
TRUE LENGTHS	8
DEVELOPMENT	17
TOTAL	34

PAPER 1 QUESTION 2
GRADE 12
FEBRUARY/MARCH 2010
MEMORANDUM

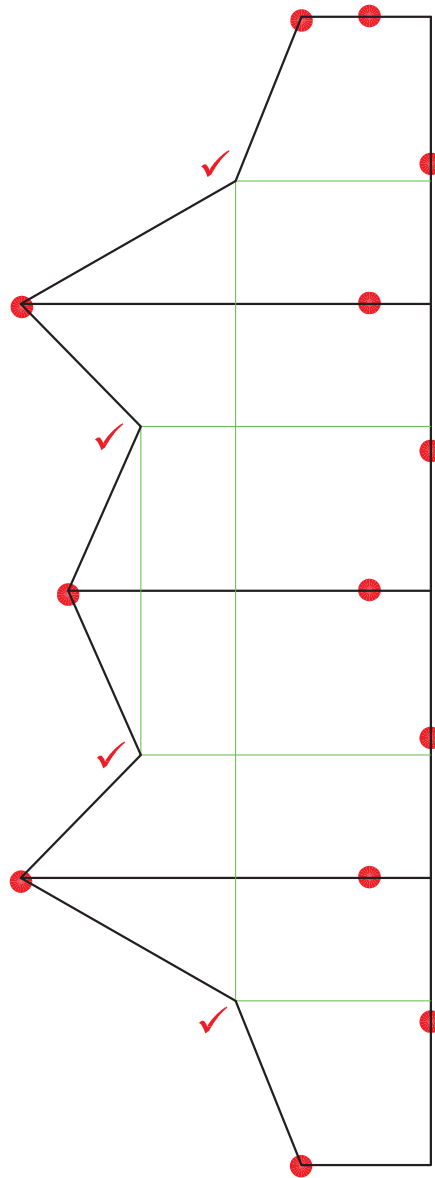
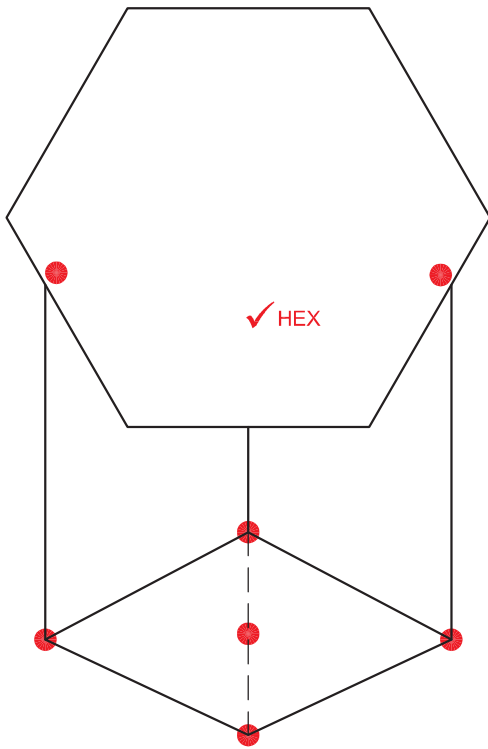
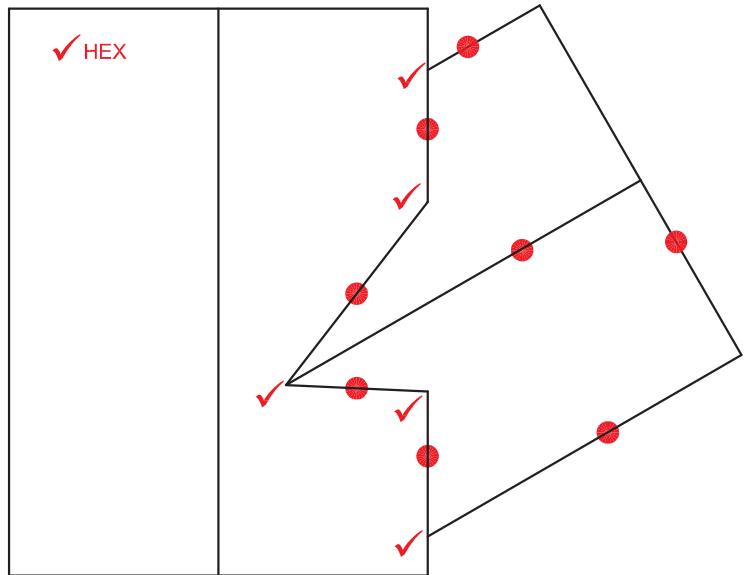
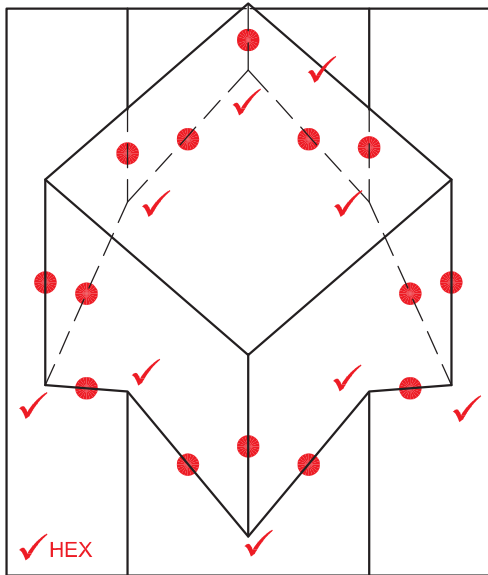

CONSTRUCTION AND PROJECTION OF SQUARE 2

● DEVELOPMENT

ASSESSMENT CRITERIA

TOP VIEW + CONSTR	6½
FRONT VIEW	17
LEFT VIEW	10
DEVELOPMENT	10½
TOTAL	44

PAPER 1 QUESTION 2
GRADE 12 NOVEMBER 2009
MEMORANDUM

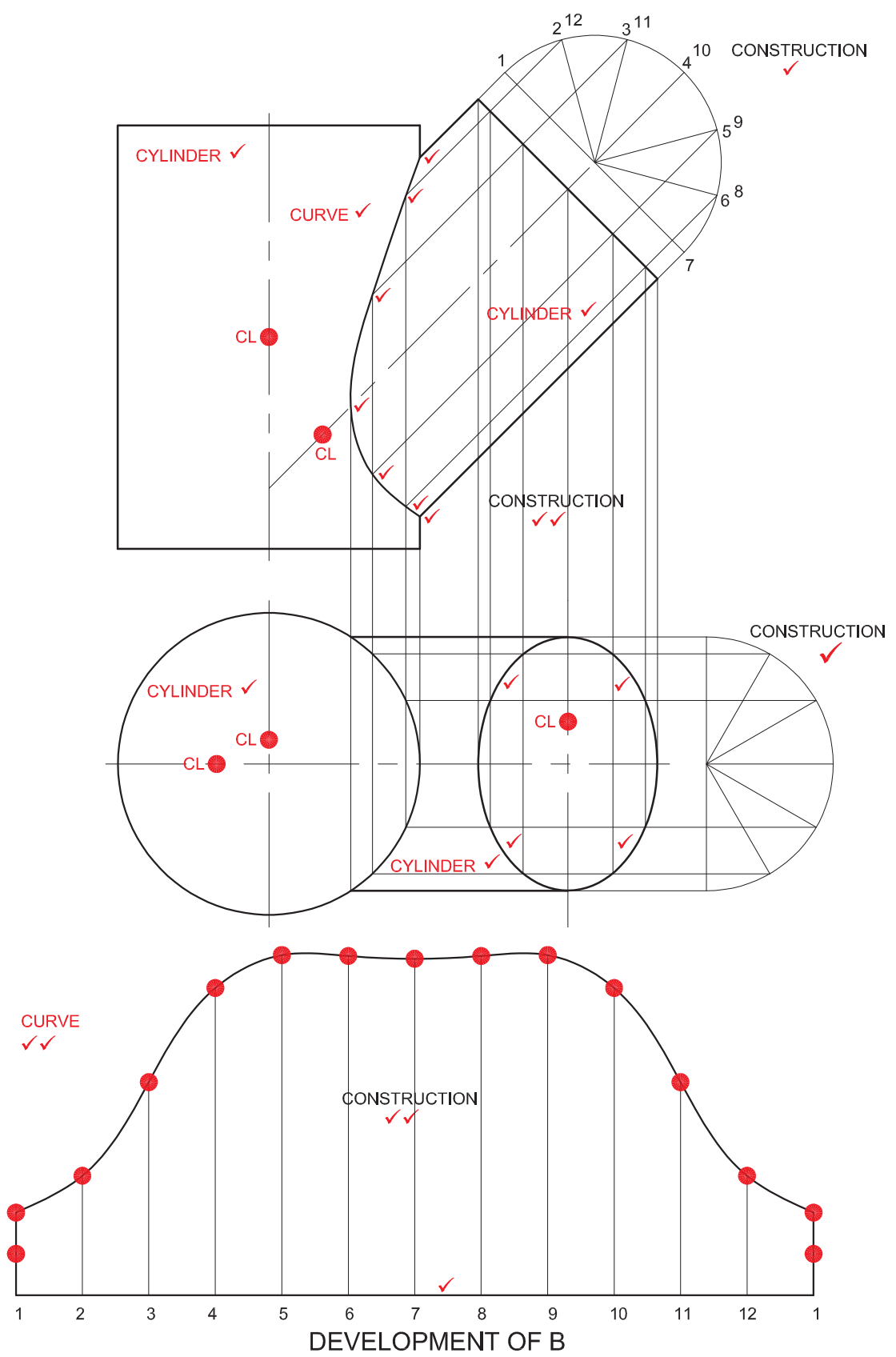

ASSESSMENT CRITERIA

FRONT VIEW	10
TOP VIEW	6
CENTRE LINES (5x½)	2½
CONSTRUCTION	6
FORMULA	2
DEVELOPMENT	10½
TOTAL	37

$\pi \times D$	✓
$\pi \times 42$	
132 (131.94)	✓

PAPER 1 QUESTION 2
 GRADE 12
 FEBRUARY/MARCH 2009
 MEMORANDUM

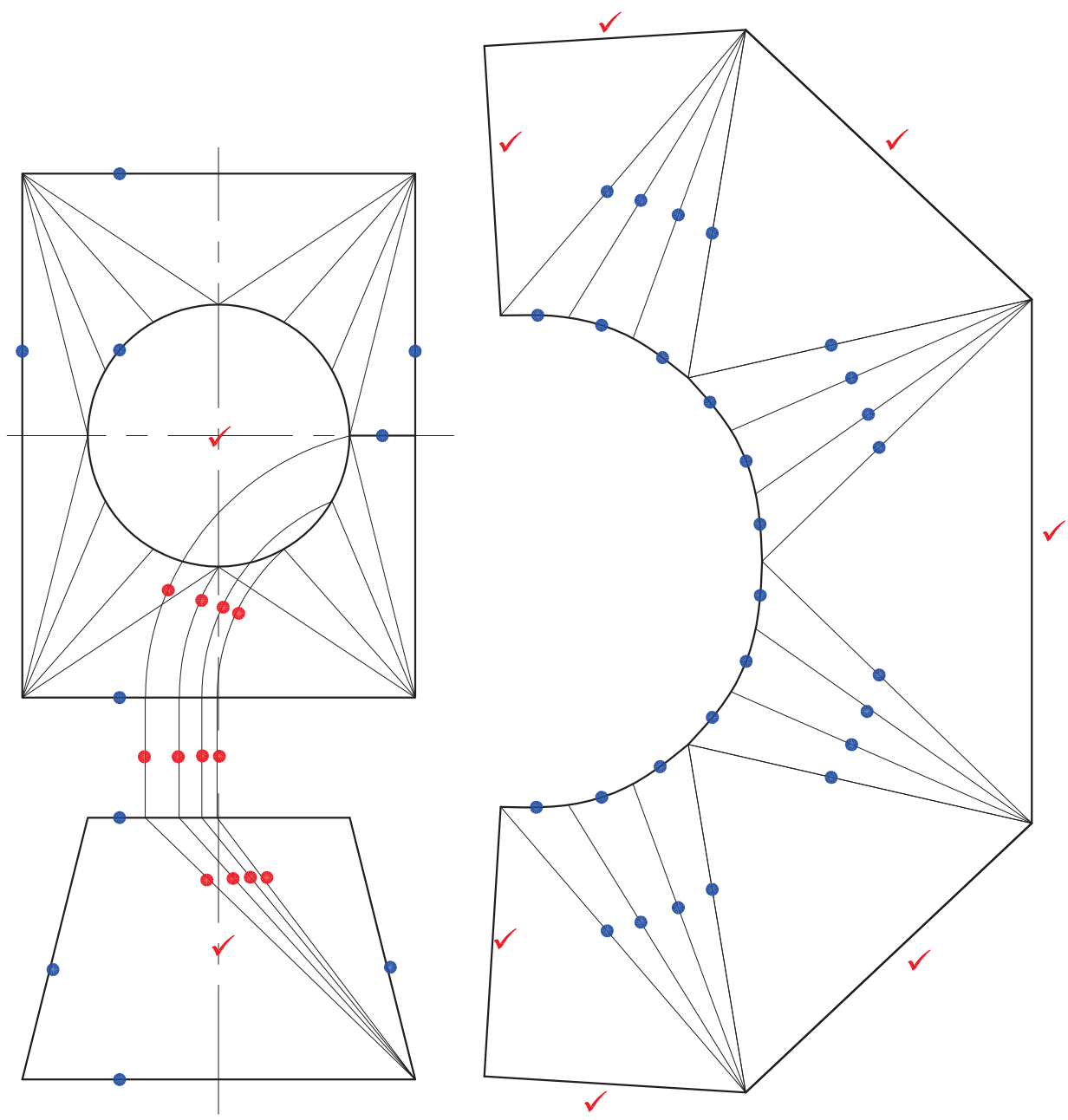

ASSESSMENT CRITERIA

FRONT VIEW	2
TOP VIEW	3
CENTRE LINES	2
TOP VIEW DIVISIONS	1
TRUE LENGTH x 4	6
DEVELOPMENT	21
TOTAL	35

QUESTION 2 PAPER 1
 GRADE 12 NOVEMBER 2008
 MEMORANDUM

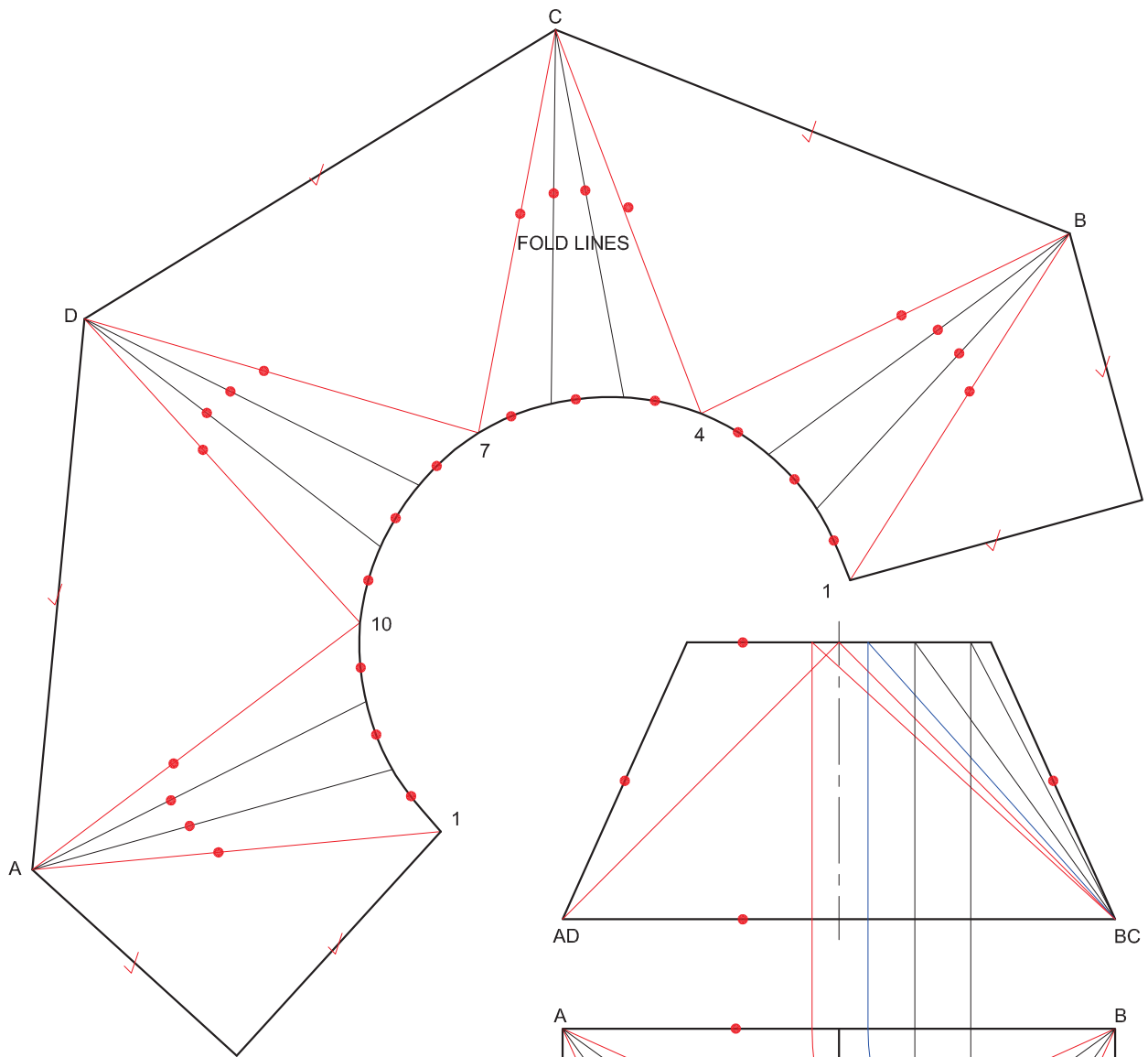

DEVELOPMENT

ASSESSMENT CRITERIA

FRONT VIEW	= 2
TOP VIEW	= 3
CIRCLE DIVISION	= 2
TRUE LENGTH x2	= 6
DEVELOPMENT	= 21
CENTRE LINES	= 1
TOTAL	= 35

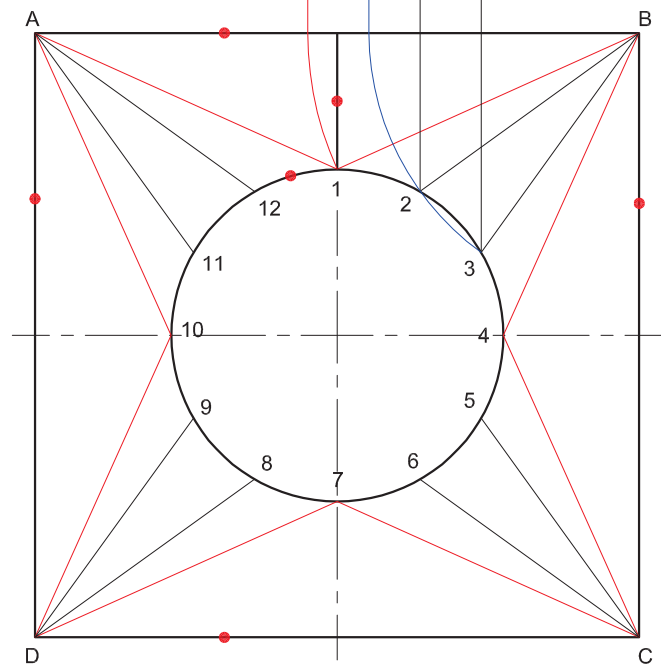

2008 GRADE 12
PAPER 1
EXEMPLAR
QUESTION 2
MEMORANDUM